

# JDS SIGN SUPPLY

A Division of JDS Industries

## 2024



**\$99 FREE FREIGHT**

**Same Day Shipping**  
on Orders Placed by 4 PM!



SIGNCAT24



jdssignsupply.com | sales@jdsindustries.com | 855.661.2388





***For all your sign supply questions, call us at 855.661.2388***



Dear Sign Professional,

We are very excited to bring you the 2024 JDS Sign Supply catalog. We continue to add more material and tools to our product mix and we hope you will find many of them useful as you continue to grow your business in 2024.

2023 was a year of stabilization in so many things. Our supply chain in general made great improvements so we were able to improve our inventories and fill rates on orders. Prices on average decreased quite a bit in 2023 which is the first time that has happened on a large scale. Inflation continues to be a factor for all of us, but that is also improving quite a bit recently and coming back down to more normal levels. On average our prices will increase 3% in 2024. Most imported products only went up a couple of percent which was nice. There was a little bit more increase on many domestically produced items, 4-5% on average. Anyone running a business in the US knows their costs are increasing on things like wages, rent, insurance and many other things, so this is really not a surprise.

We are very happy to bring some great new products to our 2024 catalog. The largest addition is Stahls'® Heat Transfer products and Hotronix heat presses which adds more than 3000 new items to what you can already purchase from JDS. Our team is very excited for this new partnership and the benefits it will bring to you such as inventory available all over the country in JDS warehouses as well as free freight, which is not something available if you order straight from the factory. We are also excited to add Weldy heat guns, more items from General Formulations, Avery Dennison and much more.

JDS is ever growing and always busy finding new ways to work with you. Our team is in the process of some more huge additions that we think you will all enjoy. Stay tuned for those as this year progresses. One of the best ways to see new products before everybody else is to attend tradeshows in your area, we bring the latest and greatest new products to all of the shows we attend.

JDS Sign Supply has 13 Warehouses across the US and over 1.3 million sq ft full of products you need. Let us be a resource for you to service your customer's needs. We look forward to talking to you either on the phone or at one of the many trade shows where we exhibit.

Let us help you make 2024 your best year ever.

~ Your JDS Sign Supply Team



*Get to know us!*



*New*  
**Stahls' CAD-CUT®  
 & CAD-COLOR®  
 Heat Transfer Material**

*New*  
**Weldy Heat Guns**



# Table of Contents

**Programs..... 4**  
**Digital Print Vinyl..... 6**  
**Color Change Wrap Film..... 46**  
**Cut Vinyl & Transfer Tapes ..... 54**  
**Banners..... 88**  
**Heat Transfer ..... 106**  
**Tools & Tapes..... 142**  
**Stand-offs & Frames ..... 178**  
**Equipment..... 212**  
**Materials & Substrates..... 240**  
**Resources & Services..... 264**  
**Index ..... 286**

*New*  
**Kota Pro H-Stakes**

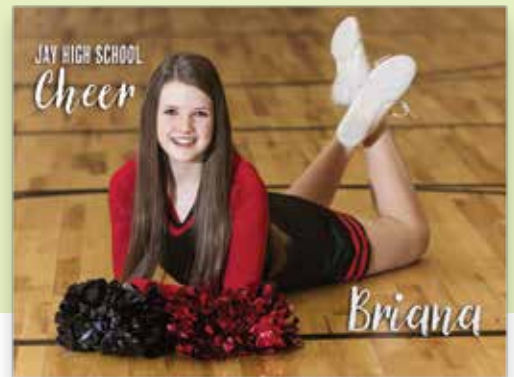

*New*  
**Aslan Printable  
 Glass Décor Film**





“ We keep coming back to JDS because of the great service, you guys are the best! Out of Marco & Johnson’s and all of them, you’re the best & we Love the free shipping. ”

- Julie,  
The Sign Studio

“ What keeps me coming back to JDS? The ease of use, the quick shipping, the free shipping with \$99 and usually spend that much every time. Have used you guys for years. When my parents owned business, they got started using JDS. Pretty much anything I need, especially with introducing all the sign supplies, it’s a one stop shop honestly. ”

- Eric Huber,  
Eric Huber LLC

# CONNECT WITH US



@JDSSIGNSUPPLY



@JDSINDUSTRIES



@JDSSIGNSUPPLY



“ Keep coming back to JDS because of the great service and the fact that we get 2 day shipments out of Seattle. Overall great company to work with! ”

- Greg Painter,  
Fast Signs

“ We order a little bit of a lot of products. I can tell you, JDS is our favorite ultimate vendor. Had Signarama training with a peer group last weekend and we have a new Signarama in town. I told them, you need to check out JDS. They’re right there on the back porch! ”

- Kendra,  
HLR Custom Graphics & Signs



## FREE FREIGHT PROGRAM

Save more \$\$\$ on shipping with JDS Industries' FREE FREIGHT Program! The minimum order to qualify is only \$99. All JDS products are included in this program unless otherwise noted in the catalog and online. Those items are flagged in the catalog as no free freight.

MDF plaques, trophy marble and marble cup bases can not be included on \$99 Free Freight orders, but are still included on Free Freight on orders of \$500 or more.

Orders less than \$99 or between \$99 and \$499 that include MDF or Marble, will qualify for our fixed rate shipping program. With this program you will know what your shipping cost is before your order is shipped. No Freight Surprises!!

JDS Customer Service or our online shopping cart will be able to tell you what on your order does not qualify for free shipping and also be able to tell you what your shipping cost will be on those items.

With \$99 free freight on most items, \$500 Free Freight on MDF & Marble, and fixed rate shipping on the items not included on Free Freight, JDS makes your shipping a whole lot easier!

# \$99 FREE FREIGHT

*Some Restrictions Apply*

### Fixed Freight Shipping

For orders not qualifying for free freight

**Orders 1-10 lbs \$15.75**

**Orders 11-25 lbs \$23.75**

**Orders 26-50 lbs \$37.25**

**Orders 51-100 lbs \$62.25**

**Orders 101-250 lbs \$112.95**

**Orders 251+ lbs \$146.95**

Programs

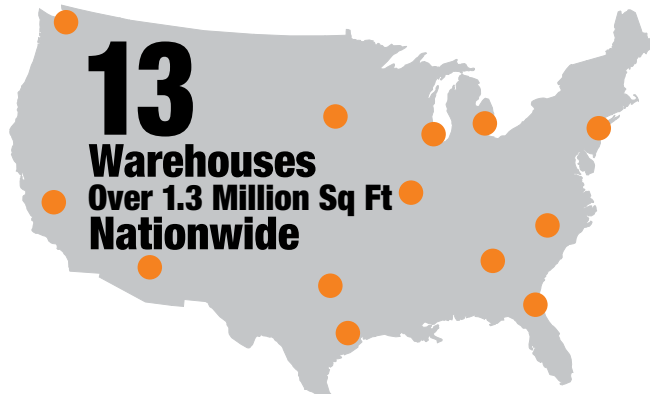

*\*Offer applies to shipping within the 48 contiguous states. Customers outside the 48 states get a 5% discount in lieu of Free Freight, or Free Freight to a US address such as a broker or forwarder. Offer is good only on published prices or quote where it is specifically included. JDS will decide shipping method based on cost, if customer has a preferred method they would pay the difference between that option and the least expensive option. Any special requirements such as liftgate, COD, etc will be at customer's expense. COD charges through UPS are not considered part of freight cost and will be billed separately.*

## Contact Us

SIGN SUPPLY LINE

**855.661.2388**

SPANISH SPEAKING LINE

LINEA DE ESPAÑOL DIRECTA

**855.661.2387**

QUALITY ASSURANCE LINE

**855.537.8478**

**FAX: 605.339.1467**



## ADVANTAGE PRICING PROGRAM



JDS Industries' Advantage Pricing program is available to those customers buying \$5,000 or more annually. Agree to order \$5,000 or more of any products from JDS during the year, and you will receive the best published price on all products purchased in unopened cases.\*

Download and complete the Advantage Pricing form from our website, [jdsindustries.com](http://jdsindustries.com). Once it is submitted and accepted you will be eligible for Advantage Pricing.

**\*Exceptions:**

**Aluminum, Brass & Steel Engraving Materials:**

*Order 25 sheets mixed for best price*

**Duets by Gemini™, JDS FLEX™ & JDS Plastics:**

*Order 10 quarter sheets mixed for best price*

or

*10 half sheets mixed for best price*

or

*5 full sheets mixed for best price*

**Gildan® or Vapor Apparel™:**

*Order 10 items mixed for best price*

**Pronto™ Individual Letters:**

*Order 25 letters or numbers mixed for best price*

**All orders for less than case quantities will be billed at less than case price.**

## DISPLAY SAMPLE PROGRAM

Earn **FREE** samples and literature whenever you buy your products through JDS Industries. All JDS customers will be eligible to receive free samples or marketing literature, up to **1%** of their prior year purchases (freight not included). JDS customer sample accounts are automatically updated January 1 each year.



**How to use your sample dollars**



- Cost on samples will be considered end quantity price for the **1%** limit.
- Additional samples above 1% of prior year purchases will be made available at end quantity price.
- Customers will pay the cost of freight on the samples (unless the samples are part of a qualifying free freight order).
- Sample Program Credits have no cash value.
- Sample Program Credits cannot be used towards purchase of equipment or ink.
- International customers will be billed 50% of end quantity price due to customs regulations. The 50% reduction will be deducted from available sample balance.

Call us or log onto [jdsindustries.com](http://jdsindustries.com) to check your current available balance.



Wrapped by Pride Neon, Sioux Falls, SD



# Digital Print Vinyl

*if you're looking for:*

CAST VINYL & WRAP KITS

HIGH PERFORMANCE CALENDERED

INTERMEDIATE CALENDERED

WALL FILMS

WINDOW FILMS

FLOOR FILMS

PROMOTIONAL CALENDERED

MAGNETIC FILM

HOLOGRAPHIC FILM

OVERLAMINATES





## Cast Removable Vinyl

### 830 AutoMark™

This premium gloss white cast wrap film with DRIFT® Technology and adhesive combination is engineered to provide superior repositionability and slidability. Developed to meet the long-term demands of full or partial wraps as well as many other graphic applications.

**OUTDOOR DURABILITY:** 7 Year/3 Year Removable

**FILM THICKNESS:** 2.0 mil Cast

**OVERLAMINATE:** 813, 831, 840, 844 or 242

**FINISH:** Gloss White

**ADHESIVE:** Grey, Solvent Slideable, Repositionable

**LINER:** 106# Air Egress Layflat

**DRY APPLY ONLY**

830 Gloss White	
Film	Part No.
54" x 150'	GF830-54
60" x 150'	GF830-60

**Common Applications:**

- Vehicle Graphics
- Fleet Graphics
- Outdoor Signage
- POP & Retail Signage



**830 AutoMark™ Wrap Kits**

Kits	Size	Part No.
830/831 Wrap Kit - 2.0 mil Gloss	54" x 150 yd	<b>GFKT831</b>
830/840 Wrap Kit - 2.0 mil Matte	54" x 150 yd	<b>GFKT840</b>
830/242 Wrap Kit - 2.0 mil Gloss Optically Clear	54" x 150 yd	<b>GFKT242</b>
830/813 Wrap Kit - 1.3 mil Gloss	54" x 150 yd	<b>GFKT813</b>
830/844 Wrap Kit - 2.0 mil Ultri-Matte	54" x 150 yd	<b>GFKT844</b>



*Overlaminates found on pages 32-45*

“ We love the film. Cold stretch is really good. Air release is good. The more we work with it, the more we love it. ”

- Lee Twait, Cutting Edgz



Vertical text: Digital Print Vinyl



## Cast Removable Vinyl

### MPI 1105 Supercast Easy Apply™ RS

When you need a vinyl that can do everything, this is the one to order. As a premium cast film, there aren't many corrugations or complex curves MPI 1105 can't handle. The RS version has adhesive that is repositionable and slideable for an easy one-person installation. If you're a seasoned installer and you don't need the slideable and repositionable properties of the 1105 EZ RS, then you can save a little money with the EZ version.

**OUTDOOR DURABILITY:** 7 Years

**OVERLAMINATE:** MPI 1105 Supercast must be laminated with DOL 1060Z, 1060MAX, 1080Z, 1360Z, 1360MAX, 1370Z, 1380Z, or 1460Z.

**FILM THICKNESS:** 2.0 mil Cast

**Common Applications:**

- Vehicle
- Fleet
- Wall Murals
- POP Displays
- Outdoor Signage
- Floor Graphics
- Marine/Watercraft (Easy Apply only)

**FINISH:** Gloss White

**ADHESIVE:** Grey Acrylic Easy Apply™ (Air Egress) Repositionable and Slidable (RS)

**LINER:** 90# Easy Apply™ & Easy Apply™ RS

**CONFORMABILITY:** Flat, flat with rivets, corrugations, complex curves (vehicle wraps)

**DRY APPLY ONLY**



MPI 1105 Supercast Easy Apply™ RS	
Film	Part No.
48" x 50 yd	A006096
54" x 50 yd	A006094
60" x 50 yd	A006091
MPI 1105 Supercast Easy Apply™	
Film	Part No.
48" x 50 yd	A006106
54" x 50 yd	A006103
60" x 50 yd	A006100



“ Avery has risen to a league of their own when it comes down to install quality and overall finish as far as looks go. Being an installer for over 15 years, there's no other product I would rather work with than Avery 1105 when it comes to vehicle graphics. ”

- Justin Vanden Bosch  
Redline Wraps & Signs



Wrapped by Redline Wraps & Signs, Harrisburg, SD

### Wrap Kits

MPI 1105 Supercast Easy Apply™ RS Wrap Kits		
Kits	Size	Part No.
MPI 1105/DOL1360Z Wrap Kit - 1.3 mil Optically Clear	54" x 50 yd	KT6483
MPI 1105/DOL1460Z Wrap Kit - 1.3 mil Gloss	54" x 50 yd	KT6499
MPI 1105/DOL1080Z Wrap Kit - 2.1 mil Matte	54" x 50 yd	KT6477
MPI 1105/DOL1060Z Wrap Kit - 2.1 mil Gloss	54" x 50 yd	KT6469



Overlaminates found on pages 32-45

## Cast Removable & Permanent Vinyl

### MPI 1405 PVC Free Easy Apply™ RS

When a standard PVC film isn't going to work and you need the conformability of a cast film, this is the answer. MPI 1405 is made of a high-grade Polyurethane that is softer and more conformable than PVC. Not only is this film the right option for moderately textured surfaces like cinder block, stucco and brick walls but it works great in hospital and restaurant settings. The high gloss finish will make your printed image pop and the grey adhesive will give you an opaque print every time!

**OUTDOOR DURABILITY:** 12 Years  
**OVERLAMINATE:** DOL6460 Cast Polyurethane  
**FILM THICKNESS:** 2.0 mil Cast Polyurethane

**Common Applications:**

- Outdoor Textured Surfaces
- Vehicle
- Fleet
- Rail Car
- POP Displays
- Outdoor Signage
- Hospitals

**FINISH:** Gloss  
**ADHESIVE:** Long Term Removable Grey Acrylic Easy Apply™ Repositionable and Slideable (RS)  
**LINER:** 90# Easy Apply™ RS  
**CONFORMABILITY:** Flat, flat with rivets, corrugations, complex curves (vehicle wraps), moderately textured walls  
**DRY APPLY ONLY**



MPI 1405 PVC Free Easy Apply™ RS	
Film	Part No.
54" x 50 yd	A019091
60" x 50 yd	A019092



ASTM E84 Class 1 or A rating

### MPI 1106 Supercast High Tack Easy Apply™

This opaque vinyl is designed for demanding applications that require the conformability of a cast film. The clear high tack adhesive is ideal when working with low energy surfaces (LSE) like plastic, powder-coated paints, fiberglass, painted metals and clear coats. MPI 1106 also comes with an air egress liner for quick bubble-free installation.

**OUTDOOR DURABILITY:** 7 Years  
**OVERLAMINATE:** MPI 1106 Supercast must be laminated with DOL 1060Z, 1060MAX, 1080Z, 1360Z, 1360MAX, 1370Z, 1380Z, or 1460Z  
**FILM THICKNESS:** 2.0 mil

**Common Applications:**

- Heavy Equipment
- Trucks and Trailers
- Buses and Transit
- Rail Car
- Commuter Rail
- Snow Vehicles
- ATV/Recreational Vehicles

**FINISH:** Gloss White  
**ADHESIVE:** Permanent Clear Acrylic Easy Apply™ (Air Egress)  
**LINER:** 90# Easy Apply™  
**CONFORMABILITY:** Flat, flat with rivets, corrugations, complex curves, **DRY APPLY ONLY**



MPI 1106 High Tack Easy Apply™	
Film	Part No.
54" x 50 yd	A006111



**Avery Dennison® Products**

Avery Dennison® Products can **ONLY** be distributed to customers in the United States and US Territories.



Digital Print Vinyl





# High Performance Calendered Permanent Vinyl

## 230 AutoMark™

This gloss white digital media is specifically engineered for use in most vehicle wrap and decal applications. The grey permanent adhesive offers excellent opacity for cover-ups and the repositionable qualities ensure a successful install for all levels of experience. The air egress liner is sure to provide a quick, easy installation.



**OUTDOOR DURABILITY:** 7 Year/2 Year Removable  
**FILM THICKNESS:** 2.4 mil  
**OVERLAMINATE:** 231, 240 813 or 844

**FINISH:** Gloss  
**ADHESIVE:** Grey, Permanent  
 Repositionable  
**LINER:** 90# Air Egress Layflat  
**DRY APPLY ONLY**

230 Gloss White	
Film	Part No.
54" x 150'	GF230-54
60" x 150'	GF230-60

**Common Applications:**

- Fleet
- Vehicle
- POP Displays
- Window Graphics
- Outdoor Signage



230 AutoMark™ Wrap Kits		
Kits	Size	Part No.
230/231 UV Wrap Kit - 2.4 mil Gloss	54" x 150 yd	GFKT231
230/240 UV Wrap Kit - 2.4 mil Matte	54" x 150 yd	GFKT240



**Note:** Application surface should always be cleaned, tested and checked for defects before applying AutoMARK™ 230 digital vehicle wrap media.

Photo Courtesy General Formulations



Overlaminates found on pages 32-45

## 333 AutoMark™ DRIFT® PW (Partial Wrap)



This version of AutoMark has a repositionable and slideable "DRIFT" adhesive allowing the installer to slide larger graphics across an OEM painted surface for exact graphic registration. This is an excellent choice for partial wrap applications when an installer can avoid deep recesses and compound curves. Save money and time with the 333 AutoMark DRIFT PW.

**OUTDOOR DURABILITY:** 7 Year/2 Year Removable  
**FILM THICKNESS:** 3.0 mil  
**OVERLAMINATE:** 231 or 240

**FINISH:** Gloss  
**ADHESIVE:** Grey, Permanent Repositionable  
**LINER:** Slideable, 105# Air-Egress  
**DRY APPLY ONLY**

**Common Applications:**

- Partial-wrap applications including:
- Vans
  - Box Trucks
  - Fleet and Recreational Vehicles



333 AutoMark Drift PW	
Film	Part No.
54" x 150'	GF333-54
60" x 150'	GF333-60



Digital Print Vinyl

## High Performance Calendered Vinyl

### MPI 2105 Easy Apply™ RS

One of the most popular and versatile calendered vinyl films from Avery Dennison, MPI 2105 is an excellent choice for vehicle, fleet and general signage applications. The repositionable and slideable adhesive allows for exact graphic registration every time! The long-term removable adhesive is also a plus for switching out old graphics with new ones. MPI 2105 is an excellent choice for all levels of installation experience.

**OUTDOOR DURABILITY:** 6 Years  
**OVERLAMINATE:** DOL2060, DOL2070 or DOL2080  
**FILM THICKNESS:** 3.1 mil

**Common Applications:**

- Fleet
- Vehicle
- POP Displays
- Window Graphics
- Outdoor Signage



**Avery Dennison® Products**

Avery Dennison® Products can **ONLY** be distributed to customers in the United States and US Territories.

**FINISH:** Gloss White  
**ADHESIVE:** Grey Acrylic Easy Apply™  
 Repositionable and Slidable (RS)  
**LINER:** 90# Easy Apply™  
**CONFORMABILITY:** Flat, simple curves  
**DRY APPLY ONLY**

MPI 2105 Easy Apply™ RS	
Film	Part No.
54" x 50 yd	A002539

MPI 2105 Easy Apply™	
Film	Part No.
54" x 50 yd	A002538



### MPI 2126 High Tack Easy Apply™

Great for low energy surfaces (LSE) such as plastics, powder-coated paints, fiberglass, clear coats and painted metals, this film is ideal for a variety of outdoor applications. The aggressive high tack adhesive is sure to hold up to the most demanding situations.

**OUTDOOR DURABILITY:** 6 Years  
**OVERLAMINATE:** DOL2080  
**FILM THICKNESS:** 3.4 mil

**Common Applications:**

- Heavy Equipment
- Trucks and Trailers
- Buses and Transit
- Rail Car
- Commuter Rail
- Snow vehicles



**FINISH:** Matte  
**ADHESIVE:** Clear Permanent  
 Easy Apply™ High Tack  
**LINER:** 90# Easy Apply™  
**CONFORMABILITY:** Flat, simple curves  
**DRY APPLY ONLY**

MPI 2126 High Tack Easy Apply™	
Film	Part No.
54" x 50 yd	A005722



*Overlaminates found on pages 32-45*

### MPI 2050 White Translucent

This translucent film is the answer for self-adhesive, illuminated signage requiring great image quality, superior stability and long term durability. The matte finish will reduce any reflection when installed on the outside of the sign face.

**OUTDOOR DURABILITY:** 6 Years  
**OVERLAMINATE:** DOL2080  
**FILM THICKNESS:** 3.4 mil  
**FINISH:** Matte Translucent

**ADHESIVE:** Clear Permanent Acrylic  
**LINER:** 90# StaFlat™  
**CONFORMABILITY:** Flat, simple curves

**Common Applications:**

- Backlit Signs



MPI 2050 White Translucent	
Film	Part No.
54" x 25 yd	A004230
54" x 50 yd	A004228
60" x 50 yd	A004229





## Intermediate Calendered Removable Vinyl

### MPI 2902

This is an excellent product for a 3-5 year outdoor project. The grey adhesive provides excellent opacity to the application surface and the film produces a high-quality image with excellent outdoor performance.

**OUTDOOR DURABILITY:** 5 Years  
**OVERLAMINATE:** DOL2060 or DOL3060  
**FILM THICKNESS:** 3.0 mil  
**FINISH:** Gloss  
**ADHESIVE:** Grey Removable  
**LINER:** 90# StaFlat™  
**CONFORMABILITY:** Flat, simple curves

**Common Applications:**

- Fleet (flat & simple curves only)
- Vehicle (flat & simple curves only)
- Wall Murals
- POP Displays
- Outdoor Signage
- Floor Graphics
- Ice Rink Boards/Dasherboards



MPI 2902 Gloss	
Film	Part No.
54" x 50 yd	A001498



**WARNING**  
 CANCER AND REPRODUCTIVE HARM  
 www.P65Warnings.ca.gov



### MPI 2921 StaFlat™ & MPI 2921 Easy Apply™

If you're trying to cover up existing graphics, this is the product to use! This specially engineered film is opaque and flexible and is also available with an Easy Apply liner for bubble-free installation. This film allows for easy installation and removal of short-term graphics, perfect for bus and transit graphics.

**OUTDOOR DURABILITY:** 2 Years  
**OVERLAMINATE:** DOL2080 or DOL3080  
**FILM THICKNESS:** 3.4 mil  
**FINISH:** Matte  
**ADHESIVE:** Grey Removable  
**LINER:** 2921 (90# StaFlat™),  
 2921 Easy Apply™ (90# Easy Apply)  
**CONFORMABILITY:** Flat, Simple Curves  
**DRY APPLY ONLY**

**Common Applications:**

- Bus/Transit Ad (flat & simple curves only)
- Fleet (flat & simple curves only)
- POP Displays
- Tradeshow
- Window Graphics
- Outdoor Signage
- Floor Graphics
- Ice Rink Boards/Dasherboards



MPI 2921 StaFlat™	
Film	Part No.
54" x 50 yd	A001099

MPI 2921 Easy Apply™	
Film	Part No.
54" x 50 yd	A005693



**WARNING**  
 CANCER AND REPRODUCTIVE HARM  
 www.P65Warnings.ca.gov



**Avery Dennison® Products**

Avery Dennison® Products can **ONLY** be distributed to customers in the United States and US Territories.

Digital Print Vinyl



## Intermediate Calendered Removable Vinyl

### 202 Matte and 204 Gloss Vinyl

This vinyl is the perfect choice for general signage applications that don't require the film to be conformed to complex curves or corrugations. The removable pressure-sensitive adhesive makes it a friendly option for temporary signage that can be applied directly to the surface, such as a glass window or door. Laminate with a long term outdoor laminate for extended outdoor life!

**OUTDOOR DURABILITY:** 5 Years/1 Year Removable  
**OVERLAMINATE:** 100 Series Short Term or 400 Series Long Term  
**FILM THICKNESS:** 3.0 mil (Gloss) 3.4 mil (Matte)

**FINISH:** Gloss (204) Matte (202)  
**ADHESIVE:** Clear Removable Acrylic  
**LINER:** 90# Layflat

**Common Applications & Surfaces:**

- Temporary Interior/Exterior Signage
- Decals
- Nameplates
- Die-cut letters
- POP Displays
- Windows



Not designed for coated/sealed/treated stainless steel, brass or bronze surfaces.

202 Matte White	
Film	Part No.
54" x 150'	GF202-54
60" x 150'	GF202-60
204 Gloss White	
Film	Part No.
54" x 150'	GF204-54
60" x 150'	GF204-60



Overlamines found on pages 32-45



### 221 Gloss and 223 Matte Semi-Rigid Vinyl

If you're printing graphics for a client but not installing them, this 6.0 mil semi-rigid vinyl will help ensure the install is a success! The thickness makes the vinyl easier to handle and has the same great removable adhesive as the 202 and 204. Remember to laminate the vinyl with a short-term or long-term overlaminate depending on where it's installed.

**OUTDOOR DURABILITY:** 3 Years/1 Year Removable  
**OVERLAMINATE:** 100 Series Short Term, 400 Series Long Term  
**FILM THICKNESS:** 6.0 mil

**FINISH:** Gloss (221) Matte (223)  
**ADHESIVE:** Clear Removable Acrylic  
**LINER:** 90# Tight Release

**Common Applications & Surfaces:**

- Temporary Interior/Exterior Signage
- Decals
- Nameplates
- Die-cut Letters
- POP Displays
- Windows
- Smooth Surfaces, Painted Metals and HSE Plastics.



Not designed for coated/sealed/treated stainless steel, brass or bronze surfaces.

221 Gloss White	
Film	Part No.
54" x 100'	GF221-54
223 Matte White	
Film	Part No.
54" x 100'	GF223-54





## Intermediate Calendered Permanent Vinyl

### MPI 2920 Series

The 2920 series is a great option when the customer requests labels, decals, or other signage. The permanent adhesive will hold on whatever it's applied to and the clear adhesive makes it a great option when you may see the backside of the vinyl from a window or glass enclosure. The matte finish will provide an aesthetically pleasing finish and reduce glare from sunlight or overhead lighting.

**OUTDOOR DURABILITY:** 5 Years  
**OVERLAMINATE:** DOL2080  
**FILM THICKNESS:** 3.4 mil

**FINISH:** Matte  
**ADHESIVE:** Clear Permanent  
**LINER:** 90# StaFlat™  
**CONFORMABILITY:** Flat, Simple Curves

**Common Applications:**

- Wall Murals
- POP Displays
- Outdoor Signage



MPI 2920 Series	
Film	Part No.
54" x 50 yd	A001098

**WARNING**  
 CANCER AND REPRODUCTIVE HARM  
[www.P65Warnings.ca.gov](http://www.P65Warnings.ca.gov)



**Avery Dennison® Products**

Avery Dennison® Products can **ONLY** be distributed to customers in the United States and US Territories.

Overlaminates found on pages 32-45

### MPI 2923 Easy Apply™

When you're asked to install a decal or graphic on a flat surface and it is larger than you're comfortable with, use this version of the 2900 series. It offers an Easy Apply liner for bubble-free installation. The grey adhesive will cover up anything that may already be on the surface without compromising the messaging displayed on the new graphic.

**OUTDOOR DURABILITY:** 5 Years  
**OVERLAMINATE:** DOL2080  
**FILM THICKNESS:** 3.4 mil

**FINISH:** Matte  
**ADHESIVE:** Grey Permanent  
**LINER:** 90# Easy Apply™  
**CONFORMABILITY:** Flat, simple curves  
**DRY APPLY ONLY**

**Common Applications:**

- Wall Murals
- POP Displays
- Outdoor Signage



MPI 2923 Easy Apply™	
Film	Part No.
54" x 50 yd	A002626
60" x 50 yd	A002625

**WARNING**  
 CANCER AND REPRODUCTIVE HARM  
[www.P65Warnings.ca.gov](http://www.P65Warnings.ca.gov)



Digital Print Vinyl

## Intermediate Calendered Permanent Vinyl

### MPI 2903 and MPI 2903 Easy Apply™

The same great option for decals, labels and POP graphics as the 2920 and 2923 Easy Apply, but with a gloss finish. 2903 works for graphics of all sizes that are applied to a flat or slightly curved surface. The larger the graphic, the more you may want to consider the Easy Apply liner. The grey adhesive comes in both versions of this film so covering up imperfections in the application surface won't be a problem.

**OUTDOOR DURABILITY:** 4 Years

**OVERLAMINATE:** DOL2060

**FILM THICKNESS:** 3.4 mil

**Common Applications:**

- Wall Murals
- POP Displays
- Outdoor Signage
- Floor Graphics
- Fleet Vehicles (flat & simple curves only)

**FINISH:** Gloss

**ADHESIVE:** Grey Permanent

**LINER:** 90# StaFlat™ (2903)  
90# Easy Apply™ (2903 Easy Apply)

**CONFORMABILITY:** Flat, simple curves

**DRY APPLY ONLY**



MPI 2903	
Film	Part No.
30" x 50 yd	A002469
54" x 50 yd	A001519
60" x 50 yd	A001518

MPI 2903 Easy Apply™	
Film	Part No.
54" x 50 yd	A002620
60" x 50 yd	A002619



### 201-OPAE Matte and 203-OPAE Gloss Opaque Vinyl

This film's grey adhesive offers great opacity in both matte and gloss. The adhesive builds to a permanent bond over 24 hours leaving it repositionable during installation. The air egress liner will also ensure installing larger decals or graphics will be bubble-free and look great.

**OUTDOOR DURABILITY:** 5 Years

**OVERLAMINATE:** 400 Series

**FILM THICKNESS:** 3.4 mil (201 OPAE) 3.0 mil (203 OPAE)

**Common Applications:**

- Large format interior or exterior signage
- Decals
- Nameplates
- POP Displays

**FINISH:** Matte (201 OPAE) Gloss (203 OPAE)

**ADHESIVE:** Grey Permanent

**LINER:** 90# Air Egress Layflat

**DRY APPLY ONLY**



201-OPAE Matte White	
Film	Part No.
54" x 150'	GF201OPAE-54

203-OPAE Gloss White	
Film	Part No.
54" x 150'	GF203OPAE-54



Digital Print Vinyl





## Intermediate Calendered Permanent Vinyl

### 201 Matte and 203 Gloss Intermediate Vinyl

These films have a strong clear permanent adhesive that will ensure an excellent bond to many common substrates used in the graphics industry. You have the option of matte or gloss and both come with a clear adhesive that offers a great value when the application doesn't require an opaque film.

**OUTDOOR DURABILITY:** 5 Years  
**OVERLAMINATE:** 400 Series Long Term, 100 Series Short Term  
**FILM THICKNESS:** 3.0 mil (Gloss) 3.4 mil (Matte)

**FINISH:** Matte (201) Gloss (203)  
**ADHESIVE:** Clear Permanent  
**LINER:** 90# Layflat

**Common Applications:**

- Large Format Interior or Exterior Signage
- Decals
- Nameplates
- POP Displays



**WARNING**  
 CANCER AND REPRODUCTIVE HARM  
 www.P65Warnings.ca.gov

Overlaminates found on pages 32-45

201 Matte White	
Film	Part No.
54" x 150'	GF201-54
60" x 150'	GF201-60

203 Gloss White	
Film	Part No.
54" x 150'	GF203-54
60" x 150'	GF203-60

### 220 Gloss and 222 Matte Semi-Rigid Vinyl

If you're printing graphics for a client but not installing them, this 6.0 mil semi-rigid vinyl will help ensure the install is a success! The thickness makes the vinyl easier to handle and has the same strong permanent adhesive as the 201 and 203. Remember to use a long term laminate when installing outdoors.

**OUTDOOR DURABILITY:** 3 Years  
**OVERLAMINATE:** 400 Series Long Term, 100 Series Short Term  
**FILM THICKNESS:** 6.0 mil

**FINISH:** Gloss (220) Matte (222)  
**ADHESIVE:** Clear Permanent  
**LINER:** 90# Tight Release

**Common Applications:**

- Interior/Exterior Signage
- Decals
- Nameplates
- POP Displays
- Die-Cut Letters



220 Gloss White	
Film	Part No.
54" x 100'	GF220-54

222 Matte White	
Film	Part No.
54" x 100'	GF222-54



Digital Print Vinyl



## Intermediate Calendered Permanent Vinyl

### 235 MotoMark® LSE GRIP Matte High-Bond Vinyl

This film has a unique high-bond adhesive designed for the powersport graphic and decal market. Have confidence that your custom graphics and decals will last when applied to low surface energy (LSE) plastics. Don't forget to pair this film with the 238 MotoMark® ARMOR overlaminates for the highest level of protection.

**OUTDOOR DURABILITY:** 5 Year

**FILM THICKNESS:** 3.4 mil

**OVERLAMINATE:** GF238 MotoMark® ARMOR

**FINISH:** Matte

**ADHESIVE:** Extremely High-Tack Clear Permanent

**LINER:** 90# PE-Coated Kraft

**CONFORMABILITY:** Flat, simple curves

**Common Applications:**

- Partial Wraps
- Powersport Vehicles
- Outdoor (long-term)



235 Matte White	
Film	Part No.
30" x 150'	GF235-30
54" x 150'	GF235-54

*Overlaminates found on pages 32-45*



### 201-HTAPAE, 201-HTAP Matte High Tack Vinyl & 203-HTAPAE, 203-HTAP Gloss High Tack Vinyl

The high tack adhesive on these films makes them great options for low surface energy (LSE) applications such as plywood, painted metals or MDO boards. An air egress liner is available to make installing larger graphics easier.

**OUTDOOR DURABILITY:** 5 Year

**OVERLAMINATE:** 400 Series Long Term, 100 Series Short Term

**FILM THICKNESS:** 3.4 mil (Matte) 3.0 mil (Gloss)

**FINISH:** 201 (Matte) 203 (Gloss)

**ADHESIVE:** Clear Acrylic High Tack Permanent

**LINER:** HTAPAE, 90# Layflat Air Egress

HTAP, 90# Layflat

**DRY APPLY ONLY**



201-HTAPAE/201-HTAPAE

**Common Applications:**

- Interior/Exterior Signage
- Decals
- Templates
- POP Displays
- Painted/Unpainted Metals
- Smooth Wood
- Plywood and MDO Board
- Vinyl
- ABS and Polystyrene
- Polyester, Polycarbonate, Smooth Polyolefins



201-HTAP/203-HTAP

201-HTAPAE- Matte White	
Film	Part No.
54" x 150'	GF201HTAPAE-54
60" x 150'	GF201HTAPAE-60

203-HTAPAE- Gloss	
Film	Part No.
54" x 150'	GF203HTAPAE-54
60" x 150'	GF203HTAPAE-60

201-HTAP-Matte White	
Film	Part No.
54" x 150'	GF201HTAP-54
60" x 150'	GF201HTAP-60

203-HTAP-Gloss	
Film	Part No.
54" x 150'	GF203HTAP-54
60" x 150'	GF203HTAP-60





## Wall Films: High Performance Calendered

### MPI 2611 Removable White Luster Wall Film

Spice up an office or hallway with Avery's most popular and versatile wall films. The clear, removable adhesive makes it perfect for swapping graphics for holidays or special events and makes the clean up a breeze. The smooth texture will make the graphic look painted onto the surface of the wall.

**INDOOR/OUTDOOR DURABILITY:** 4 Years  
**OVERLAMINATE:** DOL 1060, 1080, 2060 or 2080 Series  
**FILM THICKNESS:** 7.0 mil

**FINISH:** White Luster  
**ADHESIVE:** Clear Removable Acrylic  
**LINER:** 70# StaFlat™  
**CONFORMABILITY:** Flat

**Common Applications:**

- Wall Murals
- POP Displays

MPI 2611 Wall Film	
Film	Part No.
54" x 25 yd	A004226
54" x 50 yd	A004225



ASTM E84 Class 1 or A rating  
 CAN ULC S102.2 (MPI 2611) - Flame Spread Rating: 10, Smoke Developed Classification: 40  
 MPI 2611 meets the requirements of IMO FTP Code Part 2 & 5 for all material categories

### MPI 2630 Permanent Textured Wall Film

If a natural, unique finish is what your client is asking for, these wall films with permanent adhesive are the solution. These three natural textures will create a dynamic interior wall solution with 100% opacity to cover up any existing paint or graphics.

**INDOOR DURABILITY:** 3 Years  
**OVERLAMINATE:** N/A  
**FILM THICKNESS:** 6.0 mil (Pure Canvas & Natural Stucco)  
 8.0 mil (Crushed Stone)

**FINISH:** White Luster  
**ADHESIVE:** Clear Permanent Acrylic  
**LINER:** (2630) 90# StaFlat™  
**CONFORMABILITY:** Flat

**Common Applications:**

- Wall Murals
- POP Displays



Pure Canvas Pictured

MPI 2630 Permanent Wall Film		
Film	Texture	Part No.
54" x 25 yd	Pure Canvas	A006013
60" x 25 yd	Pure Canvas	A006014
54" x 25 yd	Natural Stucco	A006015
60" x 25 yd	Natural Stucco	A006016
54" x 25 yd	Crushed Stone	A006017
60" x 25 yd	Crushed Stone	A006018

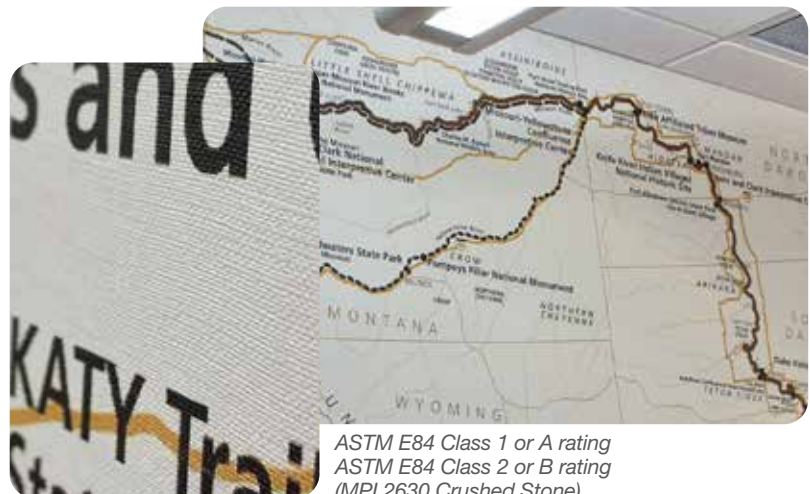

ASTM E84 Class 1 or A rating  
 ASTM E84 Class 2 or B rating  
 (MPI 2630 Crushed Stone)

**Avery Dennison® Products**

Avery Dennison® Products can **ONLY** be distributed to customers in the United States and US Territories.

Digital Print Vinyl



## Wall Films: Intermediate Calendered Removable

### 234 GraphiTex™ Matte Polyester Wall Fabric

Uniquely designed with a coated polyester fabric, this material will provide a textured surface that really enriches the look of a printed design. Not to mention, General Formulations has added a removable adhesive that makes changing graphics or designs from a painted wall easier than ever! Designed for walls only.

**DURABILITY:** 5 Years/1 Year Removable (Indoor Only)  
**OVERLAMINATE:** Not recommended due to textured face  
**FILM THICKNESS:** 7.0 mil

**FINISH:** Matte (canvas finish)  
**ADHESIVE:** Clear Low-Tack Removable Wall Adhesive  
**LINER:** 90# Layflat

**Common Applications:**  
 • Interior Walls

Not designed for coated/sealed/treated stainless steel, brass or bronze surfaces.

234 Matte White	
Film	Part No.
54" x 100'	GF234-54
60" x 100'	GF234-60



### Overlaminates found on pages 32-45

### 226 WallMark™ and 226HTR Wallmark™ Matte Semi-Rigid Wall Vinyl

The thickness of the film makes it easy to handle and the adhesive options make this a perfect choice for almost any smooth vertical surface. The smooth texture will make the graphics look painted on the wall. Choose between a traditional removable adhesive or a high tack removable (HTR) for added security on those hard to adhere surfaces.

**DURABILITY:** 3 Years/1 Year Removable (Indoor Only)  
**OVERLAMINATE:** 100 Series  
**FILM THICKNESS:** 6.0 mil

**FINISH:** Matte (smooth)  
**ADHESIVE:** 226: Clear Removable  
 226 HTR: High Tack Removable (HTR)  
**LINER:** 90# Tigt Release

**Common Applications:**  
 • Interior Walls  
 • Sealed Wall Coverings

Not designed for coated/sealed/treated stainless steel, brass or bronze surfaces.

226 Matte White	
Film	Part No.
54" x 100'	GF226-54
54" x 100'	GF226HTR-54

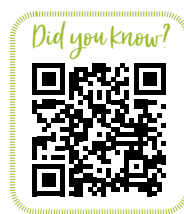

### Customer Testimonial

“ We’ve had a lot of clients very happy with this product. ”

- Thomas Wink, CEO/Co-Founder, Virtuoso Graphics, Houston, TX



Photo Courtesy Virtuoso Graphics, Houston, TX





## Wall Films: Intermediate Calendered Removable

### 229HTR High Tack Matte Canvas Textured Vinyl

Use this film for a unique indoor wall covering. The innovative pressure sensitive adhesive is designed to be high tack and removable up to one year. This artistic texture provides the look of canvas with the ease of use and durability of vinyl!

**DURABILITY:** 3 Year Outdoor/ 5 Year Indoor

**OVERLAMINATE:** ClearShield or ClearJet® by Marabu

**FILM THICKNESS:** 6.0 mil

**FINISH:** Matte

**ADHESIVE:** Clear High Tack Removable

**LINER:** 90# Layflat Liner

**Common Applications:**

- Interior Walls
- Sealed Wall Coverings



229 Matte White	
Film	Part No.
54" x 100'	GF229HTR-54
60" x 100'	GF229HTR-60

Note: Safe for all spaces with its E84 Class A Fire rating and compliance with REACH, RoHS and PROP 65.



### 285 RoughMark™ Matte Polymeric Conformable Wall Vinyl

If you're not using a wall film that is conformable to moderately textured surfaces, you're missing out! This affordable film will turn some of the most unthinkable surfaces into marketable advertising spaces! The clear high tack removable adhesive will bond to most brick, cinder block and stucco surfaces. Grab a heat gun and textured surface roller when installing.

**INDOOR/OUTDOOR DURABILITY:** 5 Years/6 Months Removable

**OVERLAMINATE:** 242 Optically Clear

**FILM THICKNESS:** 3.5 mil

**FINISH:** Matte

**ADHESIVE:** Clear Solvent High Tack Removable

**LINER:** 90# Layflat

**Common Applications:**

- Interior Walls
- Exterior Walls
- Brick, Block and Concrete Walls (VERTICAL SURFACES ONLY)



TEST all applications prior to use.

If applied to a painted surface, paint must bond tightly to the surface. Not designed for coated/ sealed/treated stainless steel, brass or bronze surfaces.

285 Matte White	
Film	Part No.
54" x 150'	GF285-54
60" x 150'	GF285-60



Digital Print Vinyl

## Window Films: Intermediate Calendered Removable



### 255 Optically Clear Printable Gloss Vinyl

Here is another film to create dimension and add an artistic flair to glass surfaces. The film comes equipped with an optically clear adhesive that provides exceptional clarity and gives the illusion that the glass and vinyl are one!

**OUTDOOR DURABILITY:** 3 Years/1 Year Removable  
**OVERLAMINATE:** 242 Optically Clear  
**FILM THICKNESS:** 3.0 mil

**FINISH:** Gloss  
**ADHESIVE:** Optically Clear Removable  
**LINER:** 2.0 mil Traction Backed Polyester  
**CONFORMABILITY:** Flat, Simple Curves

**Common Applications:**

- Short Term Interior/Exterior Signage
- Decals
- POP Displays



255 Clear Gloss	
Film	Part No.
54" x 150'	GF255-54



Digital Print Vinyl





## Window Films: Intermediate Calendered

### WindowMark™ 232 Matte Perforated 50/50 Film

The perfect film for passenger vehicles, this film has 50% of the material punched out so it is easy to see through. The black back perforated film has a clear removable adhesive and comes with a dual layflat liner that creates a “bucket” in the liner so ink can settle through the perforation and not fill the perforated holes during the printing process. The holes are .060 inches (1.5mm).

**OUTDOOR DURABILITY:** 2 Years/1 Year Removable  
**OVERLAMINATE:** 242 Optically Clear  
**FILM THICKNESS:** 6.0 mil

**FINISH:** Matte White Front/Black Back  
**ADHESIVE:** Clear Removable  
**LINER:** 84# Layflat with Dual Liner Technology

**Common Applications:**

- Flat Vertical Vehicle Windows
- Commercial Store Windows
- Interior or Exterior Glass



When this product is applied to exterior glass surfaces, the surface must be cleaned to assure adequate product bond. DO NOT use solvent or ammonia based glass cleaners for cleaning.

Product may not comply with all local DOT and Highway Safety Regulations. Check local laws prior to installation.

232 Matte White	
Film	Part No.
30" x 25'	GF232-3025
30" x 100'	GF232-30



**GREAT**  
for  
**VEHICLE**  
**WINDOWS!**

**WARNING**  
 CANCER AND REPRODUCTIVE HARM  
 www.P65Warnings.ca.gov

Overlaminates found on pages 32-45



### 270 WindowMark™ Matte Perforated 70/30 Film

If you're looking for a window perf that has great image clarity and still blocks more light than a standard 50/50 perf, try 270 Window Mark. 30% of the film is punched out with .060 (1.5mm) holes, leaving 70% left to be printed. The film has a black back with clear removable adhesive and a dual liner that assists in the printing process to keep holes free of ink build-up.

**OUTDOOR DURABILITY:** 2 Years/1 Year Removable  
**OVERLAMINATE:** 242 Optically Clear  
**FILM THICKNESS:** 6.0 mil

**FINISH:** Matte White Front/Black Back  
**ADHESIVE:** Clear Removable  
**LINER:** 84# Layflat w/ Dual Liner Technology

**Common Applications:**

- Commercial Store Windows
- Interior or Exterior Glass



When this product is applied to exterior glass surfaces, the surface must be cleaned to assure adequate product bond. DO NOT use solvent or ammonia based glass cleaners for cleaning.

Product may not comply with all local DOT and Highway Safety Regulations. Check local laws prior to installation.

270 Matte White	
Film	Part No.
54" x 25'	GF270-5425
54" x 100'	GF270-54
60" x 25'	GF270-6025
60" x 100'	GF270-60



**WARNING**  
 CANCER AND REPRODUCTIVE HARM  
 www.P65Warnings.ca.gov

Digital Print Vinyl

## Window Films: Intermediate Calendered

### 280 WindowMark™ Matte Perforated 80/20 Film

The most vibrant image you can get in window perf! This film has 20% of the material removed, leaving 80% of the material intact for a high-quality print. The clear removable adhesives are designed to remove cleanly and the black back helps you see through the .060 inch (1.5mm) holes from the reverse side.

**OUTDOOR DURABILITY:** 2 Years/1 Year Removable  
**OVERLAMINATE:** 242 Optically Clear  
**FILM THICKNESS:** 6.0 mil

**FINISH:** Matte White Front/Black Back  
**ADHESIVE:** Clear Removable  
**LINER:** 84# Layflat w/ Dual Liner Technology

**Common Applications:**

- Commercial Store Windows
- Interior or Exterior Glass



When this product is applied to exterior glass surfaces, the surface must be cleaned to assure adequate product bond. DO NOT use solvent or ammonia based glass cleaners for cleaning.

Product may not comply with all local DOT and Highway Safety Regulations. Check local laws prior to installation.

280 Matte White	
Film	Part No.
54" x 25'	GF280-5425
54" x 100'	GF280-54
60" x 25'	GF280-6025
60" x 100'	GF280-60

**WARNING**  
 CANCER AND REPRODUCTIVE HARM  
[www.P65Warnings.ca.gov](http://www.P65Warnings.ca.gov)



front view



back view



### 790AE Print-N-Privacy Polymeric Light Etched Film

When your client asks you to do something unique and different, this film is the answer. This high-quality etched vinyl is uniquely designed to simulate etched glass and is also printable so you can enhance the design with a pop of color. Whether you use it as is or you print on it, the material comes on an air egress liner so you can say yes to any job, big or small. Not recommended for small cut letters or intricate designs. Excellent for indoor and outdoor applications.

**OUTDOOR DURABILITY:** 7 Years  
**OVERLAMINATE:** Not recommended due to textured faces  
**FILM THICKNESS:** 3.0 mil

**FINISH:** Light Etched  
**ADHESIVE:** Clear Permanent  
**LINER:** 90# Paper Air Egress  
**DRY APPLY ONLY**

**Common Applications:**

- Interior or Exterior Glass
- Glass Windows or Doors



When this product is applied to exterior glass surfaces, the surface must be cleaned to assure adequate product bond. DO NOT use solvent or ammonia based glass cleaners for cleaning.

Not designed for cut lettering or to be repositioned. Transfer tape is recommended for easier application.

790AE Print Privacy	
Film	Part No.
54" x 75'	GF790AE-5475
60" x 75'	GF790AE-6075





## Window Films: Intermediate Decorative Calendered

### **NEW** Aslan Printable Glass Décor Film



This printable, self-adhesive glass decoration film is ideal for producing creative designs and sight protection on any glass surface. The unique dry apply air egress technology makes application particularly quick and easy.

**OUTDOOR DURABILITY:** 7 Years

**FILM THICKNESS:** 3.2 mil

**FINISH:** Etch, Milky White or Matte Silver

**CONFORMABILITY:** Flat Surfaces

**OVERLAMINATE:** Not Recommended

**ADHESIVE:** Clear, Semi-Permanent

**LINER:** 80# Silicone Coated Paper

**DRY APPLY ONLY**



DFL 300 Etched Glass	
Film	Part No.
54" x 164'	7292-5416-300
54" x 32.8'	7292-5404-300
27" x 164'	7292-2716-300
27" x 32.8'	7292-2704-300



Etched Glass Window Film

DFL 210 Milky White	
Film	Part No.
54" x 164'	7292-5416-301
54" x 32.8'	7292-5404-301
27" x 164'	7292-2716-301
27" x 32.8'	7292-2704-301



Milky White Window Film

DFL 302 Matte Silver	
Film	Part No.
54" x 164'	7292-5416-302
54" x 32.8'	7292-5404-302
27" x 164'	7292-2716-302
27" x 32.8'	7292-2704-302



Matte Silver Window Film

Find more  
Decorative Window Films  
on page 77

Digital Print Vinyl



## Intermediate Calendered Removable Floor Vinyl

### 212 Traffic Graffix® Matte Carpet Vinyl

If you're printing graphics for a convention or large event, you're sure to be asked about graphics for carpet! This film is specifically formulated with a clear high tack removable adhesive so graphics will bond perfectly to short nap carpets and remove cleanly when it is time to take them up. Be sure to use a laminate with the UL 410 rating for slip resistance.

**INDOOR DURABILITY:** 6 Months Removable

**OVERLAMINATE:** 109 or 211

**FILM THICKNESS:** 3.4 mil

**FINISH:** Matte

**ADHESIVE:** Clear High Tack Removable

**LINER:** 90# Layflat

**Common Applications:**

- Temporary Short Nap/Tight Weave Carpet
- Decals Advertising
- Point of Purchase Advertising



Must use a recommended UL Listed overlaminate.

212 Matte White	
Film	Part No.
54" x 150'	GF212-54



Overlaminates found on pages 32-45



Digital Print Vinyl





## Intermediate Calendered Removable Floor Vinyl

### 210 Traffic Graffix® Matte Floor Vinyl

This film is specifically designed for smooth tile or concrete commercial floor graphics. The film will last for up to 6 months under normal conditions and the clear removable adhesive will make changing graphics a breeze. Don't forget to use a laminate that is UL 410 rated for slip resistance. 210 is for indoor use only.

**INDOOR DURABILITY:** 6 Months Removable  
**OVERLAMINATE:** 109, 211 or 213  
**FILM THICKNESS:** 3.4 mil

**FINISH:** Matte  
**ADHESIVE:** Clear Removable  
**LINER:** 90# Layflat



**Common Applications:**

- Temporary Smooth Floor Graphics
- Decals Advertising
- Point of Purchase Advertising



Must use a recommended UL Listed overlaminate.

210 Matte White	
Film	Part No.
54" x 150'	GF210-54



Overlaminates found on pages 32-45



Digital Print Vinyl

## Promotional Calendered Permanent Vinyl

### MPI 3300 and MPI 3320

Save money on short term signage with this scuff-resistant, flexible promotional grade vinyl. The film is designed to deliver consistent print images at an excellent value. The clear permanent adhesive will give you confidence in its holding power for point of purchase displays, product labels and other general signage applications.

**OUTDOOR DURABILITY:** 3 Years  
**OVERLAMINATE:** DOL3060, DOL3080 or DOL3070  
**FILM THICKNESS:** 3.4 mil

**FINISH:** Gloss (3300)  
 Matte (3320)  
**ADHESIVE:** Clear Permanent  
**LINER:** 78# Clay Coated Kraft  
**CONFORMABILITY:** Flat, simple curves

**Common Applications:**

- Wall Murals
- POP Displays
- Outdoor Signage
- Floor Graphics



MPI 3300 Gloss	
Film	Part No.
54" x 50 yd	A003663

MPI 3320 Matte	
Film	Part No.
54" x 50 yd	A003815

**WARNING**  
 CANCER AND REPRODUCTIVE HARM  
[www.P65Warnings.ca.gov](http://www.P65Warnings.ca.gov)



Digital Print Vinyl







## Promotional Calendered Permanent Vinyl

### MPI 3303 and MPI 3323

These two films offer the same great value on short term signage but with a different color adhesive. The grey permanent adhesive will give you confidence in its holding power as well as covering up imperfections in the surface the vinyl is applied to. An excellent option for point of purchase displays, product labels and other general signage applications.

**OUTDOOR DURABILITY:** 3 Years  
**OVERLAMINATE:** DOL3060 or DOL3080  
**FILM THICKNESS:** 3.4 mil

**FINISH:** Gloss (3303)  
 Matte (3323)  
**ADHESIVE:** Grey Permanent  
**LINER:** 78# Clay Coated Kraft  
**CONFORMABILITY:** Flat, simple curves

**Common Applications:**

- Wall Murals
- POP Displays
- Outdoor Signage
- Floor Graphics



MPI 3303 Gloss	
Film	Part No.
54" x 50 yd	A003857

MPI 3323 Matte	
Film	Part No.
54" x 50 yd	A003919



Digital Print Vinyl



## Magnetic Material

### Magnum Magnetics

#### DigiMag® Vinyl Rolls and Pre-cut Sheets

DigiMag® Vinyl is the most popular magnetic substrate that allows you to print directly to the magnet without the need to over-laminate. The material cuts to any shape with cutters, plotters, or even a pair of scissors.

DigiMag Printable Matte White Magnetic Film		
Size	Thickness	Part No.
24.375" X 50' Roll	.015"	MAGDM-015-2450
24.375" X 25' Roll	.020"	MAGDM-020-2425
24.375" X 50' Roll	.020"	MAGDM-020-2450
24.375" X 25' Roll	.030"	MAGDG-030-2425
24.375" X 50' Roll	.030"	MAGDG-030-2450
12" X 18" Sheet	.030"	MAGSHT-030-1218
24.375" X 12" Sheet	.030"	MAGSHT-030-2412
24.375" X 18" Sheet	.030"	MAGSHT-030-2418

#### Common Applications:

- Temporary Signage
- POP Displays
- Outdoor Signage
- Vehicle Magnets (.030" Only)



#### DigiMaxx®

DigiMaxx® is a super-wide magnet for printing large-scale, high-quality images. These extra-wide magnetic sheets suit a wide range of indoor and outdoor applications. They're also compatible with the major ink systems used in the sign industry.

DigiMaxx Printable Matte White Magnetic Film		
Size	Thickness	Part No.
48" X 25' Roll	.020"	MAGDX-020-4825
48" X 50' Roll	.020"	MAGDX-020-4850
48" X 25' Roll	.030"	MAGDX-030-4825
48" X 50' Roll	.030"	MAGDX-030-4850

#### Common Applications:

- Temporary Signage
- POP Displays
- Outdoor Signage
- Vehicle Magnets (.030" Only)



Digital Print Vinyl

#### MuscleMag® Latex

If you're using a latex printer, MuscleMag® Latex is the product you need to use.

This high-energy printable magnetic material is specially formulated to be very thin to allow for smooth feeding and easy cutting while having a stronger holding power than a refrigerator magnet. MuscleMag® is perfect for vehicle signage and other signage and graphics applications that require thin but strong magnet material.

Muscle Mag White Magnetic Latex Film		
Size	Thickness	Part No.
48" x 50' Roll	.015"	MAGMM-015-4850

#### Common Applications:

- Temporary Signage
- POP Displays
- Outdoor Signage
- Vehicle Magnets



\* Test printer platen with magnet for ferromagnetic metals. Ferromagnetic metals can cause feeding issues with magnetic material.





## Permanent Holographic Film

### 765 Rainbow Holographic Film

This holographic film will create a unique look for decals that can't be duplicated with normal vinyl. This film has a permanent adhesive and is printable with latex, UV, solvent, and eco-solvent inks common to wide format digital printers.

**OUTDOOR DURABILITY:** 1 Year  
**FILM THICKNESS:** 6.0 mil  
**OVERLAMINATE:** 108, 110, 231, 242 or 400

**FINISH:** Holographic Film  
**ADHESIVE:** Clear, Permanent  
**LINER:** 90# Kraft  
**CONFORMABILITY:** Flat, Simple Curves

765 Holographic	
Film	Part No.
30" x 150'	GF765-30
30" x 75'	GF765-3075
60" x 150'	GF765-60
60" x 75'	GF765-6075

**Common Applications:**

- Decals/Stickers/Labels
- General Signage
- POP/Retail
- Window Graphics
- Indoor/Outdoor (Short-term)



Note: 60" rolls will have a "shim line" in the center of the roll and a less noticeable, repeating line, every 12" across the width of the roll. 30" rolls will have a "shim line" at the edge of the roll and a less noticeable, repeating line, every 12" across the width of the roll. To create the holographic look, the film goes through an embossing process. During this process, one or more metal shims are mounted around the circumference of a round embossing cylinder leaving behind a visible line on the material surface. This is common in most holographic films and is not considered a defect.

### Great for UV Printing!



Digital Print Vinyl

## Cast Overlaminates



### **NEW** 813 High Gloss Clear UV Cast

If you are looking for an extremely thin, highly conformable laminate this one is for you. GF 813 provides graphic protection from UV exposure, moisture and abrasion with a high gloss finish. Use with full vehicle wraps, partial wraps, fleet graphics as well as long-term applications where a high-quality cast laminate is required.

**OUTDOOR DURABILITY:** 4 Years

**FILM THICKNESS:** 1.3 mil

**FINISH:** High Gloss

**ADHESIVE:** Clear Permanent Solvent Acrylic

**LINER:** 74# White Clay-Coated Kraft

**Common Applications:**

- Fleet
- Wraps
- POP/ Retail
- Walls
- Windows
- Outdoor Signage

813 High Gloss	
Film	Part No.
54" x 150'	GF813-54
60" x 150'	GF813-60



Overlaminates

### **NEW** 844 Ulti-Matte Clear UV Cast

Made to last, GF 844 provides graphic protection from UV exposure, moisture and abrasion with an ultimate matte finish. GF cast laminates are specifically engineered for full vehicle wraps, partial wraps, fleet graphics as well as long-term applications where a high-quality cast laminate is required.

**OUTDOOR DURABILITY:** 8 Years

**FILM THICKNESS:** 2.0 mil

**FINISH:** Matte

**ADHESIVE:** Clear Permanent Solvent Acrylic

**LINER:** 74# White Clay-Coated Kraft

**Common Applications:**

- Fleet
- Wraps
- POP/ Retail
- Walls
- Windows
- Outdoor Signage

844 Matte	
Film	Part No.
54" x 150'	GF844-54
60" x 150'	GF844-60







## Cast Overlaminates

### 831 and 840 AutoMark™ UV Overlaminates

These conformable laminates provide graphic protection from UV exposure, moisture and abrasions. They're specifically engineered for the lamination of full vehicle wraps and fleet graphics or where long-term protection is required.

**OUTDOOR DURABILITY:** 8 Years

**FILM THICKNESS:** 2.0 mil

**FINISH:** Gloss (831)  
Matte (840)

**ADHESIVE:** Clear Permanent Solvent Acrylic

**LINER:** 74# White Clay-Coated Kraft

**Common Applications:**

- Fleet
- Wraps
- POP/Retail
- Wall
- Windows

831 Gloss UV	
Film	Part No.
54" x 150'	GF831-54
60" x 150'	GF831-60
840 Matte UV	
Film	Part No.
54" x 150'	GF840-54
60" x 150'	GF840-60



### DOL1060Z Gloss

This gloss overlaminate can be used with Avery Dennison's super cast digital print vinyl. This cast film is used to protect the inks printed on the cast base film while maintaining the conformable properties needed for installation. The synthetic liner creates a super smooth high gloss finish in the adhesive that gives the print a paint-like finish. This is UL 410 rated and can be used to laminate floor graphics.

**OUTDOOR DURABILITY:** Up to 5 Years

**FILM THICKNESS:** 2.1 mil

**FINISH:** Gloss

**ADHESIVE:** Clear Permanent Acrylic

**LINER:** 2.0 mil Transparent Synthetic

**CONFORMABILITY:** Flat, flat with rivets

**Common Applications:**

- Fleet
- Vehicle
- Marine/Watercraft
- Backlit Signs
- Wall Murals
- POP Displays
- Window Graphics
- Outdoor Signage
- Floor Graphics

DOL1060Z	
Film	Part No.
48" x 50 yd	A006149
54" x 50 yd	A006133
60" x 50 yd	A006131



Overlaminates

FLOOR COATING AND FINISHING MATERIAL AS TO SLIP RESISTANCE ONLY UL Reference # 16GH

**Avery Dennison® Products**

Avery Dennison® Products can **ONLY** be distributed to customers in the United States and US Territories.



## Cast Overlaminates

### **NEW** DOL 1060 Max Clear Cast

Add years of additional outdoor durability with this premium quality, ultra-thin and conformable cast overlaminate. DOL 1060 Max delivers up to 7 years vertical durability to vehicle wraps, fleet graphics, marine/watercraft, window graphics, exterior signage, POP graphics, backlit signs, wall murals and even floor graphics. Designed to be used with MPI1105 Supercast print media, 1360 Max offers a gloss finish with excellent value while providing great conformability, abrasion resistance, durability and excellent resistance to UV, temperature, humidity and salt-spray.

**OUTDOOR DURABILITY:** 7 Years  
**FILM THICKNESS:** 2.1 mil  
**FINISH:** Gloss

**ADHESIVE:** Clear, Permanent Acrylic  
**LINER:** 2 mil Transparent Synthetic  
**CONFORMABILITY:** Flat, Flat with Rivets

**Common Applications:**

- Fleet
- Vehicle
- Marine/Watercraft
- Backlit
- POP/Trade Show
- Wall Murals
- Floor Graphics
- Window Graphics
- Outdoor Signage

DOL1060MAX Gloss	
Film	Part No.
54" x 50 yd	A473092
54" x 100 yd	A473093
60" x 50 yd	A473095
60" x 100 yd	A473097



Overlaminates

### **NEW** DOL 1360 Max Clear Cast

Add years of additional outdoor durability with this premium quality, ultra-thin and conformable cast overlaminate. DOL 1360 Max delivers up to 7 years durability to vehicle wraps, window graphics and exterior signage. Designed to be used with MPI1105 Supercast print media, 1360 Max offers a gloss finish with excellent value while providing great conformability, abrasion resistance and durability with an ultra-conformable face.

**OUTDOOR DURABILITY:** 7 Years  
**FILM THICKNESS:** 1.3 mil  
**FINISH:** Optically Clear, High Gloss

**ADHESIVE:** Clear Permanent Acrylic  
**LINER:** 2 mil Transparent Synthetic  
**CONFORMABILITY:** Flat, Flat with Rivets, Corrugations, Complex Curves (vehicle wraps)

**Common Applications:**

- Vehicle
- Marine/Watercraft
- Backlit
- POP/Trade Show
- Wall Murals
- Window Graphics
- Outdoor Signage

DOL1360MAX Optical Clear Gloss	
Film	Part No.
54" x 50 yd	A473334
54" x 100 yd	A473335
60" x 50 yd	A473337







## Cast Overlaminates

### DOL1080Z Matte

This matte overlaminate can be used with Avery Dennison's super cast digital print vinyl. This cast film is used to protect the inks printed on the cast base film while maintaining the conformable properties needed for installation. The matte-like finish provides a high end, anti-glare finish to the surface of the film. DOL 1080Z is UL 410 rated and can be used to laminate floor graphics.

**OUTDOOR DURABILITY:** Up to 5 Years  
**FILM THICKNESS:** 2.1 mil  
**FINISH:** Matte

**ADHESIVE:** Clear Permanent Acrylic  
**LINER:** 83# Kraft Coated 1 Side  
**CONFORMABILITY:** Flat, flat with rivets

**Common Applications:**

- Fleet
- Vehicle
- Marine/Watercraft
- Backlit Signs
- Wall Murals
- POP Displays
- Window Graphics
- Outdoor Signage
- Floor Graphics

DOL1080Z	
Film	Part No.
48" x 50 yd	A006155
54" x 50 yd	A006153
60" x 50 yd	A006151



FLOOR COATING AND FINISHING MATERIAL  
 AS TO SLIP RESISTANCE ONLY UL Reference # 16GH

### DOL1360Z Optically Clear Gloss

As an ultra-thin, ultra-conformable cast overlaminate, this film will not only protect the printed base film but it will stand up to the most demanding installations you can find. The synthetic liner on the film provides an optically clear high gloss finish. The film boasts excellent UV, temperature, humidity and salt spray resistance. Highly recommended for window graphics and vehicle wraps.

**OUTDOOR DURABILITY:** Up to 4 Years  
**FILM THICKNESS:** 1.3 mil  
**FINISH:** Gloss

**ADHESIVE:** Clear Permanent Acrylic  
**LINER:** 2.0 mil Transparent Synthetic  
**CONFORMABILITY:** Flat, flat with rivets, corrugations, complex curves

**Common Applications:**

- Fleet
- Vehicle
- Marine/Watercraft
- Backlit Signs
- Wall Murals
- POP Displays
- Window Graphics
- Outdoor Signage

DOL1360Z	
Film	Part No.
48" x 50 yd	A006160
54" x 50 yd	A006158
60" x 50 yd	A006157



Overlaminates

## Cast Overlaminates

### DOL1370Z Luster and DOL1380Z Matte

Enhance the color and depth of your graphics with these ultra-thin and ultra-conformable cast overlaminates. The matte and luster finish provided by these overlaminates are the right choice to protect your printed graphics. These films will also protect during installation and from harmful UV rays that wreak havoc on printed graphics.

**OUTDOOR DURABILITY:** 4 Years  
**FILM THICKNESS:** 1.3 mil  
**FINISH:** Luster (1370Z)  
 Matte (1380Z)

**ADHESIVE:** Clear Permanent Acrylic  
**LINER:** 83# Kraft Coated 1 Side  
**CONFORMABILITY:** Flat, Flat with Rivets,  
 Corrugations, Complex Curves

**Common Applications:**

- Fleet
- Vehicle
- Marine/Watercraft
- Backlit Signs
- Wall Murals
- POP Displays
- Window Graphics
- Outdoor Signage

DOL1370Z Luster	
Film	Part No.
54" x 50 yd	A006163
60" x 50 yd	A006162

DOL1380Z Matte	
Film	Part No.
54" x 50 yd	A006167
60" x 50 yd	A006166



Overlaminates

### DOL1460Z High Gloss

The most conformable overlaminate we offer, this cast overlaminate allows vibrant graphics to conform to the most extreme 3D curves, corrugations and crevices without the need for a primer. You can pair this film with any of Avery Dennison's Supercast digital print vinyls for a high gloss, eye catching graphic solution.

**OUTDOOR DURABILITY:** 4 Years  
**FILM THICKNESS:** 1.3 mil  
**FINISH:** High Gloss

**ADHESIVE:** Clear Permanent Acrylic  
**LINER:** 2.0 mil Transparent Synthetic  
**CONFORMABILITY:** Flat, Flat with Rivets, Corrugations, Complex Curves, Deep Recesses

DOL1460Z High Gloss	
Film	Part No.
48" x 50 yd	A006173
54" x 50 yd	A006171
60" x 50 yd	A006170

**Common Applications:**

- Fleet
- Vehicle (Extreme Wraps)
- Marine/Watercraft
- Backlit Signs
- Wall Murals
- POP Displays
- Window Graphics
- Outdoor Signage



**WARNING**  
 CANCER AND REPRODUCTIVE HARM  
[www.P66Warnings.ca.gov](http://www.P66Warnings.ca.gov)





## Cast Overlaminates

### 242 Optically Clear UV Gloss Cast Overlamine

This cast laminate is a must-have solution for clear films, window perf or conformable vinyl. The polyester liner creates a super smooth adhesive coat that is invisible to the naked eye. Combine these benefits with the additional UV inhibitors and you'll always want this film on hand in your shop.

**OUTDOOR DURABILITY:** 5 Years  
**FILM THICKNESS:** 2.0 mil  
**FINISH:** Gloss

**ADHESIVE:** Optically Clear Permanent  
**LINER:** Smooth Frosted Polyester

**Common Applications:**

- Wraps
- Windows

242 Optically Clear	
Film	Part No.
54" x 150'	GF242-54
54" x 100'	GF242-54100
60" x 100'	GF242-60100
60" x 150'	GF242-60



### DOL6460 High Gloss PVC Free

This is a highly engineered polyurethane film for PVC Free applications. This film is super conformable and a great solution for PVC sensitive environments such as hospitals, schools and daycares. This overlamine is a necessity when tackling the most difficult complex curves and recesses.

**OUTDOOR DURABILITY:** 6 Years  
**FILM THICKNESS:** 1.5 mil  
**FINISH:** High Gloss

**ADHESIVE:** Clear Permanent Acrylic  
**LINER:** Transparent Synthetic  
**CONFORMABILITY:** Flat, Flat with Rivets, Corrugations, Complex Curves, Deep Recesses

**Common Applications:**

- Fleet
- Vehicle
- Marine/Watercraft
- Backlit Signs
- Wall Murals
- POP Displays
- Window Graphics
- Outdoor Signage
- Hospitals

DOL6460 Gloss	
Film	Part No.
54" x 50 yd	A005632
60" x 50 yd	A005615

**Avery Dennison® Products**

Avery Dennison® Products can **ONLY** be distributed to customers in the United States and US Territories.



Overlaminates

## High Performance Calendered Overlaminates

### DOL2060, DOL2070 and DOL2080 Calendered Overlaminates

These 2000 series overlaminates are specifically designed to be paired with high performance and intermediate calendered digital print vinyl from Avery Dennison. If it's a flat general signage application or one with simple curves, these are the overlaminates you need. Choose from three finishes: gloss, luster or matte.

**OUTDOOR DURABILITY:** 3 Years

**FILM THICKNESS:** 3.1 mil

**FINISH:** Gloss (2060)  
Luster (2070)  
Matte (2080)

**ADHESIVE:** Clear Permanent Acrylic

**LINER:** 78# Bleached Kraft

**CONFORMABILITY:** Flat or simple curves

**Common Applications:**

- Fleet (Flat & Simple Curves Only)
- Vehicle (Flat & Simple Curves Only)
- Backlit Signs
- Wall Murals
- POP Displays
- Window Graphics
- Outdoor Signage
- Floor Graphics



**DOL2060 Gloss**

Film	Part No.
54" x 50 yd	A004127
60" x 50 yd	A004128

**DOL2070 Luster**

Film	Part No.
54" x 50 yd	A001117
60" x 50 yd	A001455

**DOL2080 Matte**

Film	Part No.
54" x 50 yd	A004134
60" x 50 yd	A004148



ASTM E84 Class 1 or A rating

Overlaminates



Wrapped by Signarama, Sioux Falls, SD



FLOOR COATING AND FINISHING MATERIAL AS TO SLIP RESISTANCE ONLY UL Reference # 16GH





## High Performance Calendered Overlaminates

### 231 and 240 AutoMark™ UV Overlaminates

These films are the complements to 230 & 333 AutoMark digital print vinyls. Choose from matte or gloss and your cost-saving wrap is protected for 5 years. You'll be sure to impress your customers with a great vinyl and laminate kit that will make both of your checking accounts happy! You can even use gloss for window perf! Cold laminate for best results.

**OUTDOOR DURABILITY:** 5 Years

**ADHESIVE:** Clear Solvent Permanent

**FILM THICKNESS:** 2.4 mil

**LINER:** 53# White PE-Coated 1-sided Kraft

**FINISH:** Gloss (231)  
Matte (240)

**Common Applications:**

- Wrap
- Fleet
- General Signage
- Outdoor (long term)

231 Gloss UV	
Film	Part No.
54" x 150'	GF231-54
60" x 150'	GF231-60

240 Matte UV	
Film	Part No.
54" x 150'	GF240-54
60" x 150'	GF240-60

GF 230 AutoMark can be found on page 11

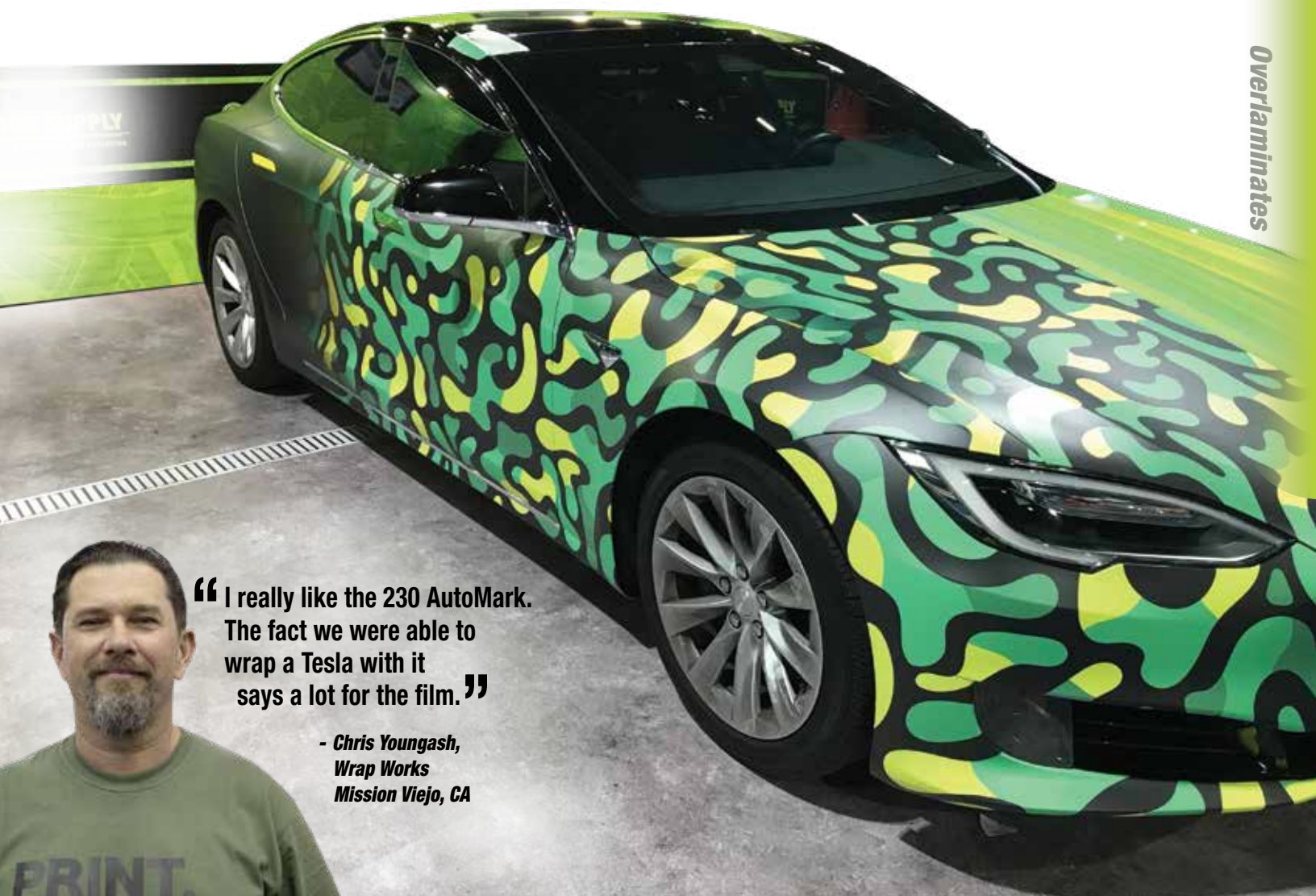

“ I really like the 230 AutoMark. The fact we were able to wrap a Tesla with it says a lot for the film. ”

- Chris Youngash,  
Wrap Works  
Mission Viejo, CA

Overlaminates



## Intermediate Calendered Overlaminates

### 238 MotoMark® ARMOR UV Overlamine

This laminate provides the ultimate protection for recreational vehicles. The film has UV inhibitors to protect your printed graphics. The extra film thickness is the best form of protection against heavy wear. There is no better option on the market to protect the plastics on quads, snowmobiles, motocross, and even helmets!

**OUTDOOR DURABILITY:** 5 Years

**FILM THICKNESS:** 12.0 mil

**FINISH:** Gloss

**ADHESIVE:** Clear Permanent

**LINER:** 45# White PE-Coated 1-sided Kraft

238 Gloss ARMOR Laminate	
Film	Part No.
30" x 75'	GF238-30
54" x 75'	GF238-54

**Common Applications:**

- Partial Wraps
- Powersport Vehicles
- General Signage
- Outdoor (long-term)

Overlaminates







## Intermediate Calendered Overlaminates

### 400 and 402 UV Clear Long Term Overlamine Film

Take advantage of this affordable, general-purpose, outdoor laminate and you won't be disappointed by the performance or the price. Choose from matte or gloss and you'll have a UV protected, moisture and abrasion resistant sign for the next 4 years. Cold laminate for best results.

**OUTDOOR DURABILITY:** 4 Years

**FILM THICKNESS:** 3.0 mil

**FINISH:** Gloss (400)  
Matte (402)

**ADHESIVE:** Clear Permanent

**LINER:** 53# White PE-Coated  
1-sided Kraft

400 Gloss UV Clear	
Film	Part No.
54" x 150'	GF400-54
60" x 150'	GF400-60

402 Matte UV Clear	
Film	Part No.
54" x 150'	GF402-54
60" x 150'	GF402-60

**Common Applications:**

- POP/Retail
- Translucent
- Transit (Flat/Simple)
- General Signage
- Outdoor (long term)



Overlaminates



## Intermediate Calendered Overlaminates

### 100 and 102 Clear Short Term Overlamine Film

If you have an indoor application that is flat and needs to get out the door quickly, grab a roll of this indoor laminate that has a reputation for exceeding expectations. Enjoy the savings while you choose from matte or gloss and remember to laminate your graphics cold for best results.

**OUTDOOR DURABILITY:** 1 Year  
**FILM THICKNESS:** 3.0 mil  
**FINISH:** Gloss (100)  
 Matte (102)

**ADHESIVE:** Clear Permanent  
**LINER:** 53# White PE-Coated  
 1-side Kraft

**Common Applications:**

- POP/Retail
- Wall
- Translucent
- Transit (Flat/Simple)
- General Signage
- Outdoor (long term)

100 Gloss Clear	
Film	Part No.
54" x 150'	GF100-54
60" x 150'	GF100-60
61" x 150'	GF100-61*

\* 61" available while supplies last.

102 Matte Clear	
Film	Part No.
54" x 150'	GF102-54
60" x 150'	GF102-60
61" x 150'	GF102-61*

\* 61" available while supplies last.



### 109 Traffic Graffix® Scratch Resistant Textured Floor Overlamine



Floor graphics are a great way to get customers on top of your message. It is extremely important that your graphics are laminated with a UL Rated laminate. This overlamine is qualified by the UL 410 classification and it is designed with a slight texture for a unique look. The 5.0 mil thickness will add to the extended life of this rugged application and the super smooth liner will make reading the graphic super easy!

**FILM THICKNESS:** 5.0 mil  
**FINISH:** Textured

**ADHESIVE:** Clear Permanent  
**LINER:** 1.5 mil Clear Polyester

**Common Applications:**

- Mouse Pads
- Counter Mats
- Decals
- Floor Graphics
- Display Overlays

The Adhesive is formulated to adhere to most printing inks. However, specific formulations must be tested before use. Some inks may contain excessive flow additives that could reduce adhesion of this product. Test before production.

109 Matte	
Film	Part No.
54" x 150'	GF109-54



TRAFFIC GRAFFIX CLASSIFIED BY UNDERWRITERS LABORATORIES, INC® AS TO SLIP RESISTANCE ONLY UL410





## Intermediate Calendered Overlaminates

### 211 Traffic Graffix® Floor Overlamine

If your clients' floors are so clean you can eat off them, you'll want a floor laminate that blends right in. This gloss, 6.0 mil is a perfect pairing to the 210 Traffic Graffix vinyl application. The exceptional clarity and UL 410 slip-resistant rating will be an easy sell for clients.

**FILM THICKNESS:** 6.0 mil

**FINISH:** Gloss

**ADHESIVE:** Clear Permanent

**LINER:** 53# White PE-Coated  
1-side Kraft

**Common Applications:**

- POP/Retail
- Floor
- Counter
- General Signage
- Indoor

The Adhesive is formulated to adhere to most printing inks. However, specific formulations must be tested before use. Some inks may contain excessive flow additives that could reduce adhesion of this product. Test before production.



TRAFFIC GRAFFIX CLASSIFIED BY UNDERWRITERS LABORATORIES, INC® AS TO SLIP RESISTANCE ONLY UL410

211 Gloss	
Film	Part No.
54" x 150'	GF211-54



### 213 Traffic Graffix® Embossed Non-PVC Floor Overlamine

Bars and restaurants are covering tables and bar tops these days with vinyl for sponsorships, seasonal messaging, etc. If there is a chance for food to make indirect contact with any of these surfaces, you need this NON-PVC laminate. An environmentally friendly product, this laminate is a great solution for floor graphics in hospitals, schools and daycares. The embossed texture also makes this unique compared to other laminates we offer.

**FILM THICKNESS:** 3.75 mil  
**FINISH:** Embossed Polypropylene

**ADHESIVE:** Clear Permanent  
**LINER:** 53# White PE-Coated  
1-side Kraft

**Common Applications:**

- POP/Retail
- Floor
- Counter
- General Signage
- Indoor (short-term)

213 is approved for indirect food contact. The Adhesive is formulated to adhere to most printing inks. However, specific formulations must be tested before use. Some inks may contain excessive flow additives that could reduce adhesion of this product. Test before production.



TRAFFIC GRAFFIX CLASSIFIED BY UNDERWRITERS LABORATORIES, INC® AS TO SLIP RESISTANCE ONLY UL410

213 Embossed	
Film	Part No.
54" x 150'	GF213-54



Overlaminates

## Promotional Calendered Overlaminates

### DOL3060, DOL3070 and DOL3080

When the job needs to be done fast and cheap, don't pass up the 3000 series overlaminates. Not only are they affordable they're the right choice for short-term promotional graphics. Make money on the jobs where the client's first expectation is cost savings. You will meet the client's expectation on price and you won't have to lay awake at night worrying about the quality you've guaranteed.

**OUTDOOR DURABILITY:** 2 Years  
**FILM THICKNESS:** 3.1 mil  
**FINISH:** Gloss (3060)  
 Luster (3070)  
 Matte (3080)

**ADHESIVE:** Clear Permanent Acrylic  
**LINER:** #51 Kraft  
**CONFORMABILITY:** Flat or simple curves

**Common Applications:**

- Backlit Signs
- Wall Murals
- POP Displays
- Window Graphics
- Outdoor Signage
- Floor Graphics

DOL3060 Gloss	
Film	Part No.
54" x 50 yd	A002498
60" x 50 yd	A002497

DOL3070 Luster	
Film	Part No.
54" x 50 yd	A002495
60" x 50 yd	A002494

DOL3080 Matte	
Film	Part No.
54" x 50 yd	A002501
60" x 50 yd	A002500



ASTM E84 Class 1 or A rating



FLOOR COATING AND FINISHING MATERIAL AS TO SLIP RESISTANCE ONLY UL Reference # 16GH

Overlaminates

## Specialty Overlaminates

### Marabu Select Liquid Overlaminates

Protect your digital prints from harmful UV for up to 5 years with ClearShield Select. Apply with a roller, foam brush or sprayer that can be rinsed off with hot water for easy clean up. Quick and easy solution for added protection. Strong chemical and mar resistance for textured vinyl and a wide range of other digital substrates.

**ClearShield Liquid**  
**Common Applications:**

- Banners
- Billboards
- Signage
- Vehicle Graphics

**ClearJet® Aerosol**  
**Common Applications:**

- Poster Paper
- Window Perf



ClearJet Aerosols can only be shipped by ground in the continental U.S.

ClearShield Select Gloss	
Part No.	Size
CSL211Q	Quart
CSL211G	Gallon

ClearShield Select Matte	
Part No.	Size
CSL214Q	Quart
CSL214G	Gallon



ClearJet 12 oz. Aerosol	
Part No.	Finish
CLJ12G	Gloss
CLJ12SG	Semi-Gloss





## Specialty Overlaminates

### 108 Tedlar® by DuPont™ Anti-Graffiti Overlamine

GF 108 made with DuPont™ Tedlar® film is easy to clean. Tedlar® film can be cleaned with a simple mixture of soap and water. Light washing should be all that is needed to keep graphics looking clean and bright. Most painted and sprayed on graffiti can be removed with suitable commercial solvents without damage to the Tedlar® surface.

**OUTDOOR DURABILITY:** 10 Years  
**FILM THICKNESS:** 1.0 mil PVF Film  
**FINISH:** Satin

**ADHESIVE:** Permanent  
**LINER:** 45# White PE-Coated Kraft

**Common Applications:**

- POP/Retail Graphics
- Wall Murals
- Window Graphics
- Fleet Wraps
- General Signage
- Outdoor Signage

GF 108	
Film	Part No.
54" x 150'	GF108-54



Before



After



### 110 EraseMark Pro™ Commercial Grade Dry Erase Overlamine

This scratch and abrasion resistant polyester film has a high performance, hard coated surface, designed to turn any graphic into a dry erase product. This film works well with quality dry erase markers and its anti-graffiti properties allow for easy removal of permanent markers or crayons. With proper care and cleaning, this film will last for years and prove it's head and shoulders above anything else you've tried.

**OUTDOOR DURABILITY:** 5 years  
**FILM THICKNESS:** 2.0 mil  
**FINISH:** Clear

**ADHESIVE:** Permanent  
**LINER:** 45# White PE-Coated Kraft

**Common Applications:**

- POP/Retail Graphics
- Wall Murals
- Window Graphics
- Indoor Signage

110 EraseMark	
Film	Part No.
54" x 150'	GF110-54

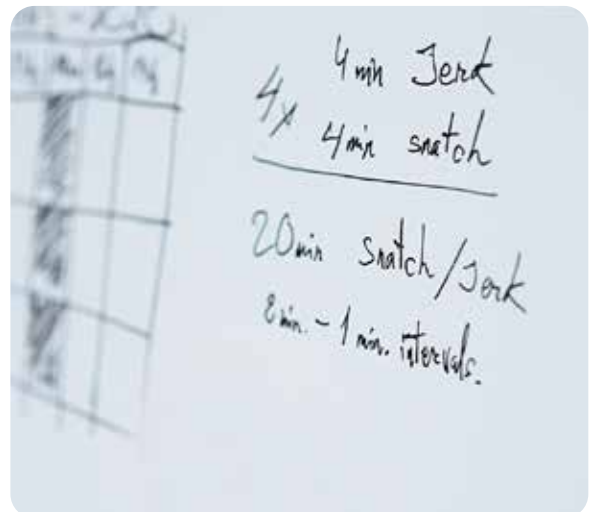

Overlaminates





# Color Change Wrap Film

*if you're looking for:*

GLOSS

SATIN

MATTE

SPECIAL EFFECTS

COLORFLOW™

PEARL

DIAMOND

EXTREME TEXTURE

RUGGED

CONFORM CHROME



## Avery Dennison Supreme Wrapping™ Film

The SW900 film is the premium choice for full vehicle wraps, partial wraps and long-term decals or graphics. This film is extremely conformable, repositionable, and comes with a long-term removable adhesive. The bubble-free liner makes applying large sections of the vinyl fast and easy. You'll have everything you need with the wide variety of textures, colors and finishes offered in this series!

**Film Thickness:** 3.2 mil to 4.7 mil for high gloss, satin or matte  
**Adhesive:** Long term removable acrylic

**Liner:** 90# StaFlat, Poly-Coated with Easy Apply RS technology  
**Durability:** Up to 12 years, depending on zone and color

### Gloss Metallic



**184 Mystery Black**  
**A409681:** 60" x 25yd



**192 Black**  
**A004369:** 60" x 25yd  
**A004540:** 60" x 5yd



**762 Radioactive**  
**A020262:** 60" x 25yd  
**A020263:** 60" x 5yd



**803 Silver**  
**A004350:** 60" x 25yd  
**A004537:** 60" x 5yd



**255 Sand Sparkle**  
**A142508:** 60" x 25yd  
**A142509:** 60" x 5yd



**700 Mysterious Indigo**  
**A409682:** 60" x 25yd



**879 Prismatic Grey**  
**A409680:** 60" x 25yd



**929 Brown**  
**A004392:** 60" x 25yd  
**A004543:** 60" x 5yd



**664 Magnetic Burst**  
**A020260:** 60" x 25yd  
**A020261:** 60" x 5yd



**816 Quick Silver**  
**A118120:** 60" x 25yd  
**A118106:** 60" x 5yd



**215 Gold**  
**A004352:** 60" x 25yd  
**A004538:** 60" x 5yd



**807 Grey**  
**A004354:** 60" x 25yd  
**A004539:** 60" x 5yd



**199 Eclipse**  
**A020256:** 60" x 25yd  
**A020257:** 60" x 5yd



**653 Dark Blue**  
**A004398:** 60" x 25yd  
**A004546:** 60" x 5yd

### Gloss



**101 White**  
**A004002:** 60" x 25yd  
**A004519:** 60" x 5yd



**190 Black**  
**A004004:** 60" x 25yd  
**A004520:** 60" x 5yd



**415 Red**  
**A004027:** 60" x 25yd  
**A004525:** 60" x 5yd



**632 Light Blue**  
**A004035:** 60" x 25yd  
**A004531:** 60" x 5yd



**249 Dark Yellow**  
**A118107:** 60" x 25yd  
**A118137:** 60" x 5yd



**373 Orange**  
**A118126:** 60" x 25yd  
**A134881:** 60" x 5yd



**612 Smoky Blue**  
**A118113:** 60" x 25yd  
**A118112:** 60" x 5yd



**667 Intense Blue**  
**A004404:** 60" x 25yd  
**A004549:** 60" x 5yd



**436 Carmine Red**  
**A004396:** 60" x 25yd  
**A004545:** 60" x 5yd



**475 Burgundy**  
**A004029:** 60" x 25yd  
**A004526:** 60" x 5yd



**656 Cloudy Blue**  
**A118138:** 60" x 25yd  
**A118117:** 60" x 5yd



**728 Light Pistachio**  
**A135202:** 60" x 25yd  
**A118116:** 60" x 5yd



**636 Aqua Blue**  
**A344788:** 60" x 25yd



**648 Sea Breeze Blue**  
**A118115:** 60" x 25yd  
**A118114:** 60" x 5yd



**699 Indigo Blue**  
**A004402:** 60" x 25yd  
**A004548:** 60" x 5yd



**832 Grey**  
**A004049:** 60" x 25yd  
**A004535:** 60" x 5yd



**677 Blue**  
**A004037:** 60" x 25yd  
**A004532:** 60" x 5yd



**681 Dark Blue**  
**A004039:** 60" x 25yd  
**A004533:** 60" x 5yd



**821 Rock Grey**  
**A142504:** 60" x 25yd  
**A142505:** 60" x 5yd



**731 Lime Green**  
**A004031:** 60" x 25yd  
**A004529:** 60" x 5yd



**792 Dark Green**  
**A004033:** 60" x 25yd  
**A004530:** 60" x 5yd



**236 Ambulance Yellow**  
**A118122:** 60" x 25yd



**865 Dark Grey**  
**A004348:** 60" x 25yd  
**A004536:** 60" x 5yd



**235 Yellow**  
**A118119:** 60" x 25yd  
**A118118:** 60" x 5yd



**433 Cardinal Red**  
**A004394:** 60" x 25yd  
**A004544:** 60" x 5yd









# Avery Dennison Supreme Wrapping™ Film (continued)

## Gloss

 **191 Obsidian Black**  
**A384511:** 60" x 25yd

## Satin Metallic

 **566 Purple**  
**A006312:** 60" x 25yd  
**A006313:** 60" x 5yd

 **805 Silver**  
**A006314:** 60" x 25yd  
**A006315:** 60" x 5yd

 **823 Black Rock Grey**  
**A344789:** 60" x 25yd

 **854 Dark Grey**  
**A389608:** 60" x 25yd

 **871 Dark Basalt**  
**A142502:** 60" x 25yd  
**A142503:** 60" x 5yd

 **260 Safari Gold**  
**A142506:** 60" x 25yd  
**A142507:** 60" x 5yd

## Satin

 **116 White**  
**A005321:** 60" x 25yd  
**A005322:** 60" x 5yd

 **712 Khaki Green**  
**A005532:** 60" x 25yd  
**A005612:** 60" x 5yd

 **833 Grey**  
**A006316:** 60" x 25yd  
**A006317:** 60" x 5yd

 **438 Carmine Red**  
**A005317:** 60" x 25yd  
**A005318:** 60" x 5yd

 **197 Black**  
**A005319:** 60" x 25yd  
**A005320:** 60" x 5yd

 **224 Yellow**  
**A135372:** 60" x 25yd  
**A135371:** 60" x 5yd

 **514 Bubblegum Pink**  
**A005282:** 60" x 25yd  
**A005316:** 60" x 5yd

 **633 Light Blue**  
**A006280:** 60" x 25yd  
**A006281:** 60" x 5yd

 **682 Dark Blue**  
**A006295:** 60" x 25yd  
**A006296:** 60" x 5yd

## Matte

 **102 White**  
**A004416:** 60" x 25yd  
**A004552:** 60" x 5yd

 **180 Black**  
**A004406:** 60" x 25yd  
**A004550:** 60" x 5yd

 **321 Orange**  
**A005109:** 60" x 25yd  
**A005569:** 60" x 5yd

 **711 Khaki Green**  
**A005531:** 60" x 25yd  
**A005611:** 60" x 5yd

 **732 Olive Green**  
**A142500:** 60" x 25yd  
**A142501:** 60" x 5yd

 **856 Dark Grey**  
**A004411:** 60" x 25yd  
**A004551:** 60" x 5yd

Color Pictured: Supreme Wrapping™, #612 Smoky Blue



Colors shown are approximate.

**WARNING**  
 CANCER AND REPRODUCTIVE HARM  
 www.P65Warnings.ca.gov



# Avery Dennison Supreme Wrapping™ Film (continued)

## Matte Metallic



**472 Garnet Red**  
**A004665:** 60" x 25yd  
**A004667:** 60" x 5yd



**520 Pink**  
**A005110:** 60" x 25yd  
**A005570:** 60" x 5yd



**643 Frosty Blue**  
**A004671:** 60" x 25yd  
**A004673:** 60" x 5yd



**858 Anthracite**  
**A005137:** 60" x 25yd  
**A005609:** 60" x 5yd



**623 Night Blue**  
**A004668:** 60" x 25yd  
**A004670:** 60" x 5yd



**671 Brilliant Blue**  
**A004662:** 60" x 25yd  
**A004664:** 60" x 5yd



**565 Purple**  
**A004646:** 60" x 25yd  
**A004648:** 60" x 5yd



**745 Apple Green**  
**A004680:** 60" x 25yd  
**A004682:** 60" x 5yd



**840 Gunmetal**  
**A004674:** 60" x 25yd  
**A004676:** 60" x 5yd



**845 Charcoal**  
**A004677:** 60" x 25yd  
**A004679:** 60" x 5yd



**857 Silver**  
**A005136:** 60" x 25yd  
**A005608:** 60" x 5yd



**615 Blue**  
**A005752:** 60" x 25yd  
**A005751:** 60" x 5yd



**737 Moss Green**  
**A350791:** 60" x 25yd

## Special Effects



**261 Energetic Yellow**  
**A177348:** 60" x 25yd



**629 Wave Blue**  
**A177463:** 60" x 25yd



**316 Stunning Orange**  
**A177464:** 60" x 25yd



**716 Cool Teal**  
**A350053:** 60" x 25yd



**448 Passion Red**  
**A177350:** 60" x 25yd



**568 Fun Purple**  
**A177349:** 60" x 25yd

*Colors shown are approximate.*

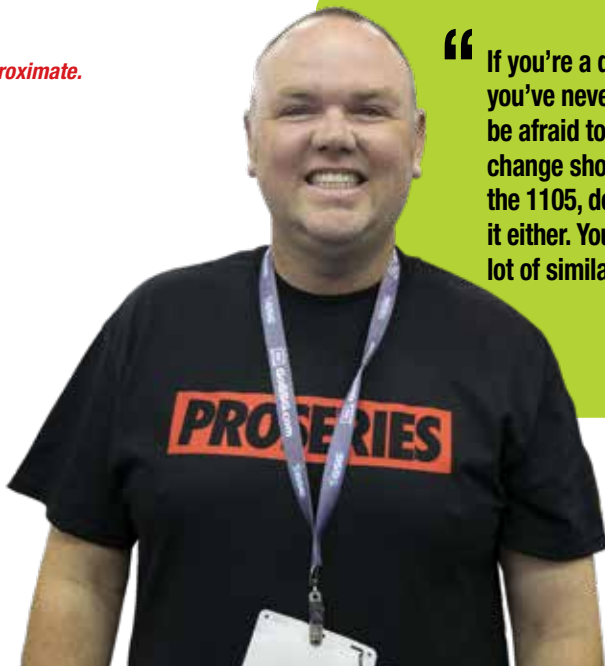

“ If you’re a digital print shop and you’ve never installed SW900, don’t be afraid to do it. And if you’re a color change shop and you haven’t installed the 1105, don’t be afraid to tackle it either. You’re going to see a lot of similarities between the two. ”

- Austin Smith,  
 Founder of Paint is Dead











# Avery Dennison Supreme Wrapping™ Film (continued)

## ColorFlow™ - Satin

- |  |  |   |
|--|--|---|
| <p><b>NEW</b>  <b>476 Solar Dawn</b><br/>Black/Red<br/><b>A512762:</b> 60" x 25yd<br/><b>A517011:</b> 60" x 5yd</p> | <p><b>NEW</b>  <b>788 Frozen Ocean</b><br/>Cyan/Blue<br/><b>A512764:</b> 60" x 25yd<br/><b>A517013:</b> 60" x 5yd</p> | <p><b>NEW</b>  <b>634 Moonstone</b><br/>Silver/Blue<br/><b>A512763:</b> 60" x 25yd<br/><b>A517012:</b> 60" x 5yd</p> |
| <p> <b>251 Fresh Spring</b><br/>Gold/Silver<br/><b>A006174:</b> 60" x 25yd<br/><b>A006175:</b> 60" x 5yd</p>        | <p> <b>673 Rushing Riptide</b><br/>Cyan/Purple<br/><b>A006193:</b> 60" x 25yd<br/><b>A006194:</b> 60" x 5yd</p>       | <p> <b>610 Lightning Ridge</b><br/>Green/Purple<br/><b>A006325:</b> 60" x 25yd<br/><b>A006326:</b> 60" x 5yd</p>     |
| <p> <b>551 Roaring Thunder</b><br/>Blue/Red<br/><b>A006178:</b> 60" x 25yd<br/><b>A006179:</b> 60" x 5yd</p>        | <p> <b>446 Rising Sun</b><br/>Red/Gold<br/><b>A006176:</b> 60" x 25yd<br/><b>A006177:</b> 60" x 5yd</p>               | <p> <b>786 Urban Jungle</b><br/>Silver/Green<br/><b>A006195:</b> 60" x 25yd<br/><b>A006196:</b> 60" x 5yd</p>        |

## ColorFlow™ - Gloss

- |   |   |  |   |
|---|---|--|---|
| <p> <b>252 Fresh Spring</b><br/>Gold/Silver<br/><b>A006207:</b> 60" x 25yd<br/><b>A006208:</b> 60" x 5yd</p>  | <p> <b>674 Rushing Riptide</b><br/>Cyan/Purple<br/><b>A006226:</b> 60" x 25yd<br/><b>A006227:</b> 60" x 5yd</p> | <p> <b>611 Lightning Ridge</b><br/>Green/Purple<br/><b>A006327:</b> 60" x 25yd<br/><b>A006328:</b> 60" x 5yd</p> | <p> <b>789 Hidden Forest</b><br/><b>A409683:</b> 60" x 25yd</p> |
| <p> <b>552 Roaring Thunder</b><br/>Blue/Red<br/><b>A006224:</b> 60" x 25yd<br/><b>A006225:</b> 60" x 5yd</p> | <p> <b>447 Rising Sun</b><br/>Red/Gold<br/><b>A006209:</b> 60" x 25yd<br/><b>A006223:</b> 60" x 5yd</p>        | <p> <b>787 Urban Jungle</b><br/>Silver/Green<br/><b>A006246:</b> 60" x 25yd<br/><b>A006247:</b> 60" x 5yd</p>   |   |



Color Pictured: ColorFlow™, #634 Moonstone

Colors shown are approximate.



Color Change Wrap Film



## Avery Dennison Supreme Wrapping™ Film (continued)

### Pearl



**109 Gloss White**  
**A004371:** 60" x 25yd  
**A004541:** 60" x 5yd



**777 Light Green**  
**A005090:** 60" x 25yd  
**A005567:** 60" x 5yd



**796 Dark Green**  
**A005009:** 60" x 25yd  
**A005011:** 60" x 5yd

### Diamond



**161 Diamond White**  
**A005755:** 60" x 25yd  
**A005756:** 60" x 5yd



**221 Diamond Amber**  
**A005757:** 60" x 25yd  
**A005758:** 60" x 5yd



**426 Diamond Red**  
**A005759:** 60" x 25yd  
**A005780:** 60" x 5yd



**587 Diamond Purple**  
**A005781:** 60" x 25yd  
**A005782:** 60" x 5yd



**676 Diamond Blue**  
**A005783:** 60" x 25yd  
**A005784:** 60" x 5yd



**878 Diamond Silver**  
**A005836:** 60" x 25yd  
**A005837:** 60" x 5yd

### Extreme Texture



**115 Carbon Fiber White**  
**A004749:** 60" x 25yd  
**A004750:** 60" x 10yd



**193 Brushed Black**  
**A004717:** 60" x 25yd  
**A004722:** 60" x 5yd



**194 Carbon Fiber Black**  
**A004734:** 60" x 25yd  
**A004735:** 60" x 10yd



**802 Brushed Titanium**  
**A004715:** 60" x 25yd  
**A004720:** 60" x 5yd



**812 Brushed Aluminum**  
**A004716:** 60" x 25yd  
**A004721:** 60" x 5yd



**813 Brushed Steel**  
**A004719:** 60" x 25yd  
**A004724:** 60" x 5yd



**933 Brushed Bronze**  
**A004718:** 60" x 25yd  
**A004723:** 60" x 5yd

Colors shown are approximate.





# Avery Dennison Supreme Wrapping™ Film (continued)

## Rugged



**182 Onyx Black**  
A381867: 60" x 25yd



**738 Marsh Green**  
A381868: 60" x 25yd



**718 Combat Green**  
A381883: 60" x 25yd



**824 Bedrock Grey**  
A381887: 60" x 25yd



Color Pictured: Rugged, Onyx Black

Colors shown are approximate.

## Conform Chrome



**843 Silver**  
A134229: 53" x 5yd  
A118109: 53" x 10yd  
A118154: 53" x 25yd



**211 Rose Gold**  
A118141: 53" x 5yd  
A118147: 53" x 10yd  
A118144: 53" x 25yd



**256 Blue**  
A134232: 53" x 5yd  
A118149: 53" x 10yd  
A118151: 53" x 25yd



**844 Matte Silver**  
A118139: 53" x 5yd  
A118155: 53" x 10yd  
A118142: 53" x 25yd



**474 Red**  
A134237: 53" x 5yd  
A118150: 53" x 10yd  
A118152: 53" x 25yd



**196 Black**  
A134235: 53" x 5yd  
A118148: 53" x 10yd  
A118145: 53" x 25yd



**604 Gold**  
A134231: 53" x 5yd  
A118108: 53" x 10yd  
A118153: 53" x 25yd



Wrap work & photo by #201WRAP

Color Change Wrap Film





# Cut Vinyl & Transfer Tapes

*if you're looking for:*

**CAST**

**TRANSLUCENT**

**CALENDERED**

**METALLIC**

**REFLECTIVE**

**PAINT MASK**

**STATIC CLING**

**SPECIAL EFFECTS**

**TRANSFER TAPES**



# 3M™ Scotchcal™ ElectroCut™ Cast Film Series 7125

If you're getting asked about long term cut graphics, this 2.0 mil, cast metallic film, is specifically designed for that purpose. This film will last for 8 years outdoors and is also extremely conformable. The clear adhesive on this film will also look great on windows allowing the installer to apply graphics indoors or outdoors. **(For unpunched material, start the part number with 7125, for punched use 7175.)**

**3M** | Authorized Distributor

	<b>114</b> Transparent		<b>101</b> Nimbus Gray		<b>099</b> Fawn		<b>013</b> Tomato Red
	<b>010</b> Gloss White		<b>012</b> Black		<b>065</b> Light Lemon Yellow		<b>293</b> Atomic Red
	<b>020</b> Matte White		<b>022</b> Matte Black		<b>015</b> Bright Yellow		<b>063</b> Geranium
	<b>090</b> Antique White		<b>069</b> Duranodic		<b>025</b> Sunflower		<b>053</b> Cardinal Red
	<b>011</b> Pearl Gray		<b>019</b> Deep Mahogany Brown		<b>064</b> Apricot		<b>023</b> Deep Red
	<b>121</b> Light Gray		<b>029</b> Russet Brown		<b>105</b> Harvest Gold		<b>093</b> Imperial Red
	<b>031</b> Medium Gray		<b>059</b> Putty		<b>024</b> Terra Cotta		<b>058</b> Burgundy
	<b>091</b> Dove Gray		<b>081</b> Stone Gray		<b>054</b> Light Orange		<b>103</b> Magenta
	<b>061</b> Mid Gray		<b>089</b> Sandstone		<b>014</b> Bright Orange		<b>273</b> Process Magenta
	<b>151</b> Traffic Gray		<b>039</b> Tan		<b>074</b> Red Orange		
	<b>041</b> Dark Gray		<b>049</b> Beige		<b>263</b> Perfect Match Red		

7125 Series	7125 Series
Size	Size
15" x 10 yard	15" x 50 yard
24" x 10 yard	24" x 50 yard
30" x 10 yard	30" x 50 yard
48" x 10 yard	48" x 50 yard

7175 Punched Series	7175 Punched Series
Size	Size
15" x 10 yard	15" x 50 yard
30" x 10 yard	30" x 50 yard



All colors stocked in 24" x 10 yards

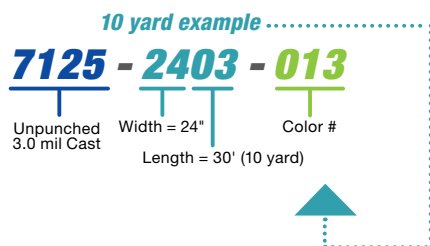

### 3M™ Products

3M Products can **ONLY** be distributed to customers in the United States and US Territories.

**Note: Punched film is only available in 15" & 30" - use part number 7175.**  
**Note: Colors shown are approximate.**





# 3M™ Scotchcal™ ElectroCut™ Cast Film Series 7125

**FILM THICKNESS:** 2.0 mil Cast PVC  
**FINISH:** Gloss  
**OUTDOOR DURABILITY:** 8 Years

**ADHESIVE/COLOR:** Permanent /Clear  
**LINER:** 78# Kraft  
**CONFORMABILITY:** Flat Surfaces, with or without Rivets, Simple Curves

**3M** Authorized Distributor



**098**  
Dark Violet



**177**  
Shadow Blue

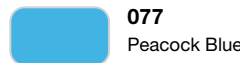

**077**  
Peacock Blue



**046**  
Kelly Green



**078**  
Plum



**037**  
Sapphire Blue



**187**  
Wedgewood Blue



**186**  
Bright Green



**048**  
Purple



**017**  
Vivid Blue

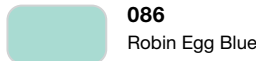

**086**  
Robin Egg Blue



**056**  
Dark Green



**038**  
Royal Purple



**047**  
Intense Blue



**307**  
Dark Aqua



**016**  
Khaki Green



**027**  
Indigo



**117**  
Persian Blue



**096**  
Teal



**066**  
Forest Green



**127**  
Boat Blue



**057**  
Olympic Blue



**357**  
Bermuda Blue



**276**  
Bottle Green



**197**  
Light Navy



**107**  
Light Blue



**136**  
Lime Green

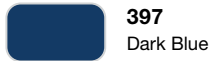

**397**  
Dark Blue



**097**  
Soft Blue



**196**  
Apple Green



243 Steampunk Red Metallic

## Metallics



**120**  
Satin Aluminum

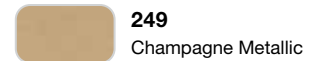

**249**  
Champagne Metallic



**201**  
Slate Metallic



**229**  
Copper Metallic



**211**  
Charcoal Metallic

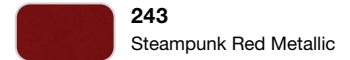

**243**  
Steampunk Red Metallic

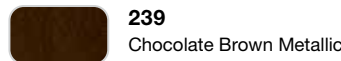

**239**  
Chocolate Brown Metallic

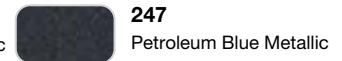

**247**  
Petroleum Blue Metallic



**241**  
Gold Metallic



**227**  
Bright Blue Metallic



**131**  
Satin Gold

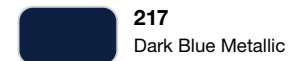

**217**  
Dark Blue Metallic

7125 Series	7125 Series
Size	Size
15" x 10 yard	15" x 50 yard
24" x 10 yard	24" x 50 yard
30" x 10 yard	30" x 50 yard
48" x 10 yard	48" x 50 yard

7175 Punched Series	7175 Punched Series
Size	Size
15" x 10 yard	15" x 50 yard
7175 Punched Series	30" x 50 yard
Size	
30" x 10 yard	

All colors stocked in 24" x 10 yards





Authorized Distributor

## 3M™ Scotchcal™ ElectroCut™ Cast Film Series 7725

This series has all the same great color options, outdoor durability and conformability as the 7125 series. The big difference with this series is the synthetic liner that resists moisture absorption and static build-up, making it easier to cut and weed letters as small as 1/4".

**(For unpunched material, start the part number with 7725, or punched use 7775.)**

	<b>114</b> Transparent		<b>101</b> Nimbus Gray		<b>099</b> Fawn		<b>013</b> Tomato Red
	<b>010</b> White		<b>012</b> Black		<b>065</b> Light Lemon Yellow		<b>293</b> Atomic Red
	<b>020</b> Matte White		<b>022</b> Matte Black		<b>015</b> Bright Yellow		<b>063</b> Geranium
	<b>090</b> Antique White		<b>069</b> Duranodic		<b>025</b> Sunflower		<b>053</b> Cardinal Red
	<b>011</b> Pearl Gray		<b>019</b> Deep Mahogany Brown		<b>064</b> Apricot		<b>023</b> Deep Red
	<b>121</b> Light Gray		<b>029</b> Russet Brown		<b>105</b> Harvest Gold		<b>093</b> Imperial Red
	<b>031</b> Medium Gray		<b>059</b> Putty		<b>024</b> Terra Cotta		<b>058</b> Burgundy
	<b>091</b> Dove Gray		<b>081</b> Stone Gray		<b>054</b> Light Orange		<b>103</b> Magenta
	<b>061</b> Mid Gray		<b>089</b> Sandstone		<b>014</b> Bright Orange		<b>273</b> Process Magenta
	<b>151</b> Traffic Gray		<b>039</b> Tan		<b>074</b> Red Orange		
	<b>041</b> Dark Gray		<b>049</b> Beige		<b>263</b> Perfect Match Red		

Cut Vinyl

7725 Series	7725 Series
Size	Size
15" x 10 yard	15" x 50 yard
24" x 10 yard	24" x 50 yard
30" x 10 yard	30" x 50 yard
48" x 10 yard	48" x 50 yard

7775 Punched Series	7775 Punched Series
Size	Size
15" x 10 yard	15" x 50 yard
30" x 10 yard	30" x 50 yard



### 3M™ Products

3M Products can **ONLY** be distributed to customers in the United States and US Territories.

**Note: Punched film is only available in 15" & 30" - use part number 7775.**

**Note: Colors shown are approximate.**

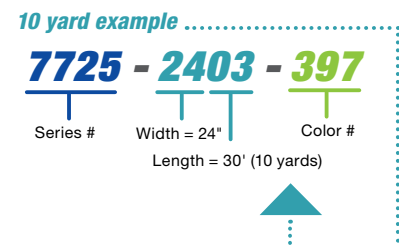



# 3M™ Scotchcal™ ElectroCut™ Cast Film Series 7725

**FILM THICKNESS:** 2.0 mil Cast PVC **ADHESIVE/COLOR:** Permanent/Clear  
**FINISH:** Gloss **LINER:** Transparent Synthetic  
**OUTDOOR DURABILITY:** 8 Years **CONFORMABILITY:** Flat Surfaces, with or without Rivets, Simple Curves

**3M** Authorized Distributor

- 098** Dark Violet
- 078** Plum
- 048** Purple
- 038** Royal Purple
- 027** Indigo
- 127** Boat Blue
- 197** Light Navy
- 397** Dark Blue
- 177** Shadow Blue
- 037** Sapphire Blue
- 017** Vivid Blue
- 047** Intense Blue
- 117** Persian Blue
- 057** Olympic Blue
- 107** Light Blue
- 097** Soft Blue
- 077** Peacock Blue
- 187** Wedgwood Blue
- 086** Robin Egg Blue
- 307** Dark Aqua
- 096** Teal
- 357** Bermuda Blue

- 136** Lime Green
- 196** Apple Green
- 046** Kelly Green
- 186** Bright Green
- 056** Dark Green
- 016** Khaki Green
- 066** Forest Green
- 276** Bottle Green

## Metallics

- 120** Satin Aluminum
- 201** Slate Metallic
- 211** Charcoal Metallic
- 239** Chocolate Brown Metallic
- 241** Gold Metallic
- 249** Champagne Metallic
- 131** Satin Gold
- 229** Copper Metallic
- 243** Steampunk Red Metallic
- 247** Petroleum Blue Metallic
- 227** Bright Blue Metallic
- 217** Dark Blue Metallic



7725 Series	7725 Series
Size	Size
15" x 10 yard	15" x 50 yard
24" x 10 yard	24" x 50 yard
30" x 10 yard	30" x 50 yard
48" x 10 yard	48" x 50 yard

7775 Punched Series	7775 Punched Series
Size	Size
15" x 10 yard	15" x 50 yard
30" x 10 yard	30" x 50 yard



Cut Vinyl





# 3M™ Controllac™ Cast Film with Comply™ Adhesive Series 180mC

This premium vinyl series has all the bells and whistles of cast cut vinyl. You still have all the color options of the 7125 and 7725 series along with exceptional outdoor durability. The big thing you gain is advanced conformability. The micro comply adhesive offers a bubble-free, repositionable feature that makes installation on larger graphics fast and easy.



Authorized Distributor

Cut Vinyl

	<b>020</b> Matte White		<b>069</b> Duranodic		<b>024</b> Terra Cotta
	<b>114</b> Transparent		<b>019</b> Deep Mahogany Brown		<b>054</b> Light Orange
	<b>010</b> White (Gray Adhesive)		<b>029</b> Russet Brown		<b>014</b> Bright Orange
	<b>090</b> Antique White		<b>059</b> Putty		<b>074</b> Red Orange
	<b>011</b> Pearl Gray		<b>081</b> Stone Gray		<b>263</b> Perfect Match Red
	<b>121</b> Light Gray		<b>089</b> Sandstone		<b>013</b> Tomato Red
	<b>031</b> Medium Gray		<b>039</b> Tan		<b>293</b> Atomic Red
	<b>091</b> Dove Gray		<b>049</b> Beige		<b>063</b> Geranium
	<b>061</b> Mid Gray		<b>099</b> Fawn		<b>053</b> Cardinal Red
	<b>151</b> Traffic Gray		<b>065</b> Light Lemon Yellow		<b>023</b> Deep Red
	<b>041</b> Dark Gray		<b>015</b> Bright Yellow		<b>093</b> Imperial Red
	<b>101</b> Nimbus Gray		<b>025</b> Sunflower		<b>058</b> Burgundy
	<b>012</b> Black		<b>064</b> Apricot		<b>103</b> Magenta
	<b>022</b> Matte Black		<b>105</b> Harvest Gold		<b>273</b> Process Magenta



180mC Series	180mC Series
Size	Size
24" x 10 yard	24" x 50 yard
48" x 10 yard	48" x 50 yard



*Note: Colors shown are approximate.*

### 3M™ Products

3M Products can **ONLY** be distributed to customers in the United States and US Territories.



# 3M™ Controltac™ Cast Film with Comply™ Adhesive Series 180mC

**FILM THICKNESS:** 2.0 mil Cast PVC **ADHESIVE/COLOR:** Removable, Repositionable, Pressure Activated/Gray  
**FINISH:** Gloss **LINER:** Polyethylene-coated Paper  
**OUTDOOR DURABILITY:** 7 Years **CONFORMABILITY:** Flat Surfaces, with or without Rivets, Simple Curves, Compound Curves and Corrugations  
**INSTALLATION:** **DRY APPLY ONLY**



Authorized Distributor



**098**  
Dark Violet



**078**  
Plum



**048**  
Purple



**038**  
Royal Purple



**027**  
Indigo



**127**  
Boat Blue



**197**  
Light Navy



**397**  
Dark Blue



**177**  
Shadow Blue



**037**  
Sapphire Blue



**017**  
Vivid Blue



**047**  
Intense Blue



**117**  
Persian Blue



**057**  
Olympic Blue



**107**  
Light Blue



**097**  
Soft Blue



**077**  
Peacock Blue



**187**  
Wedgewood Blue



**086**  
Robin Egg Blue



**307**  
Dark Aqua



**096**  
Teal



**357**  
Bermuda Blue



**136**  
Lime Green



**196**  
Apple Green



**046**  
Kelly Green



**186**  
Bright Green



**056**  
Dark Green



**016**  
Khaki Green



**066**  
Forest Green



**276**  
Bottle Green

## Metallics



**120**  
Satin Aluminum



**201**  
Slate Metallic



**211**  
Charcoal Metallic



**239**  
Chocolate Brown Metallic



**241**  
Gold Metallic



**131**  
Satin Gold



**249**  
Champagne Metallic



**229**  
Copper Metallic



**243**  
Steampunk Red Metallic



**247**  
Petroleum Blue Metallic



**227**  
Bright Blue Metallic



**217**  
Dark Blue Metallic

180mC Series	180mC Series
Size	Size
24" x 10 yard	24" x 50 yard
48" x 10 yard	48" x 50 yard



Cut Vinyl

10 yard example

**180MC2403 - 013**

Unpunched 2.0 mil Cast    Width = 24"    Length = 30' (10 yds)    Color #





## 3M™ Scotchcal™ Translucent™ Graphic Film Series 3630

This translucent film series has a superior matte finish that eliminates glare and provides a uniform color when backlit. You can use this film inside or outside on the first or second surface of a rigid substrate. The film is specifically engineered for use with internally illuminated sign faces.

**3M** | Authorized Distributor

*(For unpunched material, start the part number with 3630, for punched use 3680.)*

	<b>020</b> White		<b>328</b> Berry Burgundy		<b>074</b> Kumquat Orange		<b>136</b> Lime Green
	<b>111</b> Dover White		<b>053</b> Cardinal Red		<b>124</b> Burnt Orange		<b>146</b> Light Kelly Green
	<b>022</b> Black		<b>073</b> Dark Red		<b>144</b> Poppy Orange		<b>116</b> Bright Jade Green
	<b>068</b> Rose Mauve		<b>083</b> Regal Red		<b>135</b> Yellow Rose		<b>086</b> Blue Lagoon
	<b>108</b> Pink		<b>033</b> Red		<b>235</b> Autumn Yellow		<b>156</b> Vivid Green
	<b>038</b> Fuchsia		<b>093</b> Fire Engine Red		<b>025</b> Sunflower		<b>196</b> Forest
	<b>098</b> Electric Pink		<b>163</b> Scarlet		<b>075</b> Marigold		<b>316</b> Jade Green
	<b>078</b> Vivid Rose		<b>043</b> Light Tomato Red		<b>125</b> Golden Yellow		<b>026</b> Green
	<b>118</b> Intense Magenta		<b>143</b> Poppy Red		<b>015</b> Yellow		<b>056</b> Glacial Green
	<b>133</b> Raspberry		<b>044</b> Orange		<b>115</b> Light Lemon Yellow		<b>076</b> Holly Green
	<b>049</b> Burgundy		<b>084</b> Tangerine		<b>106</b> Brilliant Green		<b>126</b> Dark Emerald Green

Cut Vinyl







# 3M™ Scotchcal™ Translucent™ Graphic Film Series 3630

**FILM THICKNESS:** 2.0 mil Cast PVC  
**FINISH:** Low Surface Gloss  
**OUTDOOR DURABILITY:** 7 Years

**ADHESIVE/COLOR:** Permanent/Clear  
**LINER:** Transparent Synthetic  
**CONFORMABILITY:** Flat surfaces

**3M** | Authorized Distributor

<b>246</b> Teal Green	<b>287</b> Marine Blue	<b>137</b> European Blue	<b>059</b> Dark Brown
<b>236</b> Turquoise	<b>227</b> Azure	<b>187</b> Infinity Blue	<b>063</b> Rust brown
<b>276</b> Kentucky Bluegrass	<b>337</b> Process Blue	<b>077</b> Indigo	<b>109</b> Light Rust Brown
<b>216</b> Blue Coral	<b>217</b> Deep Sea Blue	<b>087</b> Royal Blue	<b>129</b> Bronze
<b>127</b> Intense Blue	<b>147</b> Light European Blue	<b>128</b> Plum Purple	<b>005</b> Ivory
<b>037</b> Sapphire	<b>057</b> Olympic Blue	<b>158</b> Bright Violet	<b>039</b> Warm Beige
<b>097</b> Bristol Blue	<b>317</b> Evening Blue	<b>051</b> Silver Grey	<b>149</b> Light Beige
<b>167</b> Bright Blue	<b>027</b> Electric Blue	<b>071</b> Shadow Grey	<b>131</b> Gold Metallic
<b>047</b> Patriot Blue	<b>297</b> Twilight Blue	<b>061</b> Slate Grey	<b>141</b> Gold Nugget
<b>157</b> Sultan Blue	<b>036</b> Blue	<b>069</b> Duranodic	<b>121</b> Silver

3630 Series	3630 Series
Size	Size
24" x 10 yard	24" x 50 yard
48" x 10 yard	48" x 50 yard

**Common Applications:**

- Indoor/Outdoor Illuminated Signs

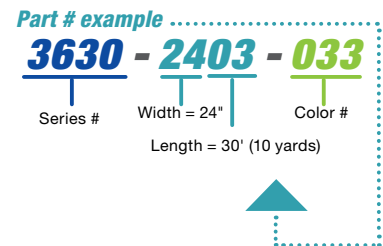

3M™ Scotchcal Translucent Film Series 3630 and 3M™ Envision™ Translucent Film Series 3730 (the "Products") have matte surface finish, eliminating glare and providing uniform color in reflected and transmitted light

**Note:** Colors shown are approximate.

**3M™ Products**

3M Products can **ONLY** be distributed to customers in the United States and US Territories.



Authorized Distributor

## 3M™ Scotchcal™ Calendered Film Series 50

For jobs that are flat, quick and easy, save money with this intermediate calendered film. Good for indoor or outdoor applications, this film will cut and weed like a champ. If you like to stay on time and budget, this 3M film needs to be part of your offering.

**(For unpunched material, start the part number with 0050, for punched use 0055.)**

**FILM THICKNESS:** 3.0 mil Calendered PVC    **ADHESIVE/COLOR:** Removable (Up to 3 years with heat) /Clear  
**FINISH:** High Gloss    **LINER:** White and Blue Kraft Paper  
**OUTDOOR DURABILITY:** 5 Years    **CONFORMABILITY:** Flat surfaces and simple curves

- |  |                                  |  |                           |
|--|----------------------------------|--|---------------------------|
|  | <b>011</b><br>Transparent        |  | <b>120</b><br>Matte Black |
|  | <b>010</b><br>White (Blue Liner) |  | <b>092</b><br>Brown       |
|  | <b>100</b><br>Matte White        |  | <b>054</b><br>Gold        |
|  | <b>094</b><br>Light Gray         |  | <b>914</b><br>Beige       |
|  | <b>097</b><br>Nimbus Gray        |  | <b>064</b><br>Pink        |
|  | <b>058</b><br>Silver             |  | <b>044</b><br>Light Red   |
|  | <b>012</b><br>Black              |  | <b>483</b><br>Dark Red    |



Cut Vinyl

50 Series		50 Series	
Size		Size	
15" x 10 yard		15" x 50 yard	
24" x 10 yard		24" x 50 yard	
30" x 10 yard		30" x 50 yard	
48" x 10 yard		48" x 50 yard	

55 Punched Series		55 Punched Series	
Size		Size	
15" x 10 yard		15" x 50 yard	
30" x 10 yard		30" x 50 yard	



**Note: Punched film is only available in 15" & 30" - use part number 0055.**  
**Note: Colors shown are approximate.**

### 3M™ Products

3M Products can **ONLY** be distributed to customers in the United States and US Territories.

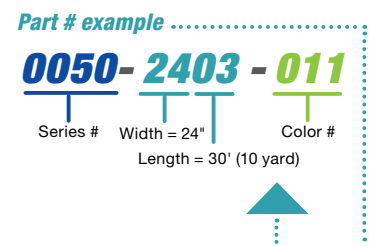



Authorized Distributor

## 3M™ Scotchcal™ Calendered Film Series 50

For jobs that are flat, quick and easy, save money with this intermediate calendered film. Good for indoor or outdoor applications, this film will cut and weed like a champ. If you like to stay on time and budget, this 3M film needs to be part of your offering.

**(For unpunched material, start the part number with 0050, for punched use 0055.)**

**FILM THICKNESS:** 3.0 mil Calendered PVC     **ADHESIVE/COLOR:** Removable (Up to 3 years with heat) /Clear  
**FINISH:** High Gloss     **LINER:** White and Blue Kraft Paper  
**OUTDOOR DURABILITY:** 5 Years     **CONFORMABILITY:** Flat surfaces and simple curves

- |   |  |
|---|--|
|  <b>049</b><br>Burgundy      |  <b>078</b><br>Dark Green     |
|  <b>034</b><br>Bright Orange |  <b>079</b><br>Teal           |
|  <b>027</b><br>Sunflower     |  <b>082</b><br>Light Blue     |
|  <b>024</b><br>Lemon Yellow  |  <b>084</b><br>Azure Blue     |
|  <b>073</b><br>Grass Green   |  <b>088</b><br>Sapphire Blue  |
|  <b>745</b><br>Bright Green  |  <b>090</b><br>Deep Navy Blue |
|  <b>076</b><br>Medium Green |  <b>066</b><br>Purple        |



Cut Vinyl

50 Series		50 Series	
Size		Size	
15" x 10 yard		15" x 50 yard	
24" x 10 yard		24" x 50 yard	
30" x 10 yard		30" x 50 yard	
48" x 10 yard		48" x 50 yard	

55 Punched Series		55 Punched Series	
Size		Size	
15" x 10 yard		15" x 50 yard	
30" x 10 yard		30" x 50 yard	



**Note: Punched film is only available in 15" & 30" - use part number 0055.**  
**Note: Colors shown are approximate.**

### 3M™ Products

3M Products can **ONLY** be distributed to customers in the United States and US Territories.

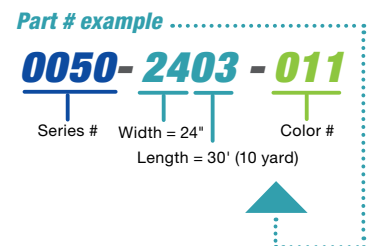





# Lumina™ Ultra High Gloss Calendered Vinyl Series 4200

Save money with this intermediate calendered film that offers a high gloss face film that is sure to last. This film is flexible, durable and resilient to harmful UV rays. You'll find that it weeds, cuts and transfers exceptionally well and has a wide variety of colors compared to the leading competitors. You will want to consider this vinyl for applications like architectural signage, POP graphics, banner, decals, striping and more.

**(For unpunched material, start the part number with 4200, for punched use 4250.)**

**FILM THICKNESS:** 2.8 mil Calendered PVC **ADHESIVE/COLOR:** Permanent/Clear  
**FINISH:** High Gloss **LINER:** 78# Kraft  
**OUTDOOR DURABILITY:** 5 Years **CONFORMABILITY:** Flat Surfaces and Simple Curves

<b>000</b> Clear	<b>004</b> Gold	<b>172</b> Poppy Red	<b>005</b> Blue
<b>200</b> Matte Clear	<b>068</b> Beige	<b>001</b> Red	<b>032</b> Azure Blue
<b>002</b> Gloss White	<b>182</b> Sunbeam Yellow	<b>012</b> Burgundy	<b>018</b> Olympic Blue
<b>049</b> Matte White	<b>080</b> Matte Yellow	<b>076</b> Magenta	<b>108</b> Peacock Blue
<b>202</b> Restful White	<b>067</b> Primrose Yellow	<b>124</b> Fiesta Pink	<b>206</b> Breakfast Blue
<b>102</b> Crystal White (Blue Liner)	<b>025</b> Sunflower	<b>063</b> Violet	<b>071</b> Teal
<b>007</b> Silver	<b>006</b> Yellow	<b>075</b> Lavender	<b>142</b> Forest Green
<b>050</b> Medium Grey	<b>224</b> Rose Gold	<b>074</b> Royal Purple	<b>024</b> Dark Green
<b>003</b> Gloss Black	<b>113</b> Coral	<b>168</b> Plum	<b>126</b> Emerald Green
<b>268</b> Flat Black	<b>133</b> Tangerine	<b>011</b> Dark Blue	<b>061</b> Kelly Green
<b>040</b> Matte Black	<b>014</b> Tomato Red	<b>266</b> Patriot Blue	<b>252</b> Mint Green
<b>008</b> Brown	<b>125</b> Wild Cardinal Red	<b>017</b> Sapphire Blue	<b>257</b> Lime Green

Cut Vinyl

4200 Series	
Size	
15" x 10 yard	
24" x 10 yard	
30" x 10 yard	
48" x 10 yard	

4200 Series	
Size	
15" x 50 yard	
24" x 50 yard	
30" x 50 yard	
48" x 50 yard	

4250 Punched Series	
Size	
15" x 10 yard	
4250 Punched Series	
Size	
15" x 50 yard	

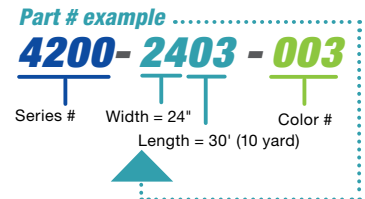

**Note: Punched film is only available in 15" - use part number 4350.**  
**Note: Colors shown are approximate.**



# Lumina™ Satin Calendered Removable Vinyl Series 4301

This calendered vinyl is designed for producing specialty graphics for painted interior walls. Apply inspiring messages, corporate logos or quotes without being concerned about the vinyl removing poorly or failing prematurely. These graphics look great in kitchens, bedrooms, hallways, breakrooms, or lobbies. The satin finish blends in with the most common paint finishes for a high-quality professional look. For best results when transferring the graphics to the wall, use RTape 4000 ApliTape or 560U Low Tack. **(For unpunched material, start the part number with 4301, for punched use 4351.)**

**FILM THICKNESS:** 3.0 mil Calendered PVC  
**FINISH:** Matte  
**OUTDOOR DURABILITY:** 3 Years/1 Year Removable  
**ADHESIVE/COLOR:** Removable/Clear  
**LINER:** 78# Clay Coated  
**CONFORMABILITY:** Flat Surfaces

<b>049</b> White (Blue Liner)	<b>004</b> Gold	<b>001</b> Red	<b>108</b> Peacock Blue
<b>202</b> Restful White	<b>068</b> Beige	<b>124</b> Fiesta Pink	<b>206</b> Breakfast Blue
<b>007</b> Silver	<b>080</b> Matte Yellow	<b>076</b> Magenta	<b>252</b> Mint Green
<b>050</b> Medium Grey	<b>113</b> Coral	<b>168</b> Plum	<b>257</b> Lime Green
<b>008</b> Brown	<b>133</b> Tangerine	<b>011</b> Dark Blue	<b>126</b> Emerald Green
<b>040</b> Black	<b>125</b> Wild Cardinal Red	<b>032</b> Azure Blue	<b>142</b> Forest Green

4301 Series	4301 Series
Size	Size
15" x 10 yard	15" x 50 yard
24" x 10 yard	24" x 50 yard
48" x 10 yard	48" x 50 yard

4351 Punched Series	4351 Punched Series
Size	Size
15" x 10 yard	15" x 50 yard

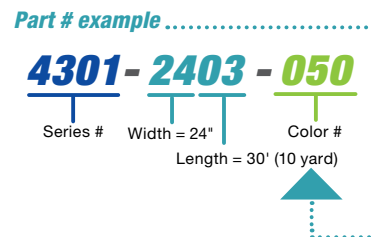

**Note: Punched film is only available in 15" - use part number 4251.**  
**Note: Colors shown are approximate.**



# 3M™ Controltac™ Cast Film with Comply™ Adhesive Series 180mC

This premium vinyl series has all the bells and whistles for cast cut vinyl. You still have all the color options of the 7125 and 7725 series and exceptional outdoor durability. The big thing you gain is the advanced conformability. The micro comply adhesive offers a bubble free, repositionable feature that makes installation on larger graphics fast and easy.



Authorized Distributor

**FILM THICKNESS:** 2.0 mil Cast PVC  
**FINISH:** Gloss  
**OUTDOOR DURABILITY:** 7 Years  
**INSTALLATION:** **DRY APPLY ONLY**

**ADHESIVE/COLOR:** Positionable, Pressure Activated/Gray  
**LINER:** Polyethylene-coated paper  
**CONFORMABILITY:** Flat Surfaces, with or without Rivets, Simple Curves, Moderate Compound Curves

**120**  
Satin Aluminum

**131**  
Satin Gold

**201**  
Slate Metallic

**211**  
Charcoal Metallic

**239**  
Chocolate Brown Metallic

**241**  
Gold Metallic

**249**  
Champagne Metallic

**229**  
Copper Metallic

**243**  
Steampunk Red Metallic

**247**  
Petroleum Blue Metallic

**227**  
Bright Blue Metallic

**217**  
Dark Blue Metallic

180mC Series	180mC Series
Size	Size
24" x 10 yard	24" x 50 yard
48" x 10 yard	48" x 50 yard



**Note: To order 180mC vinyls see part number example.**



**3M™ Products**

3M Products can **ONLY** be distributed to customers in the United States and US Territories.

**Note: Colors shown are approximate.**

**180MC2403 - 013**  
 Unpunched 2.0 mil Cast | Width = 24" | Length = 30' (10 yds) | Color #

**180MC4815 - 013**  
 Unpunched 2.0 mil Cast | Width = 48" | Length = 150' (50 yds) (The 0 in 150 is hidden) | Color #





## 3M™ Scotchcal™ ElectroCut™ Cast Film Series 7125

If you're getting asked about long term cut graphics, this 2.0 mil, cast metallic film, is specifically designed for that purpose. This film will last for 8 years outdoors and is also extremely conformable. The clear adhesive on this film will also look great on windows allowing the installer to apply graphics indoors or outdoors.



Authorized Distributor

**(For unpunched material, start the part number with 7125, for punched use 7175.)**

<b>FILM THICKNESS:</b>	2.0 mil Cast PVC	<b>ADHESIVE/COLOR:</b>	Permanent/Clear
<b>FINISH:</b>	Gloss	<b>LINER:</b>	78# Kraft
<b>OUTDOOR DURABILITY:</b>	8 Years	<b>CONFORMABILITY:</b>	Flat surfaces, with or without Rivets, Simple Curves



**120**  
Satin Aluminum



**201**  
Slate Metallic



**229**  
Copper Metallic



**131**  
Satin Gold



**211**  
Charcoal Metallic

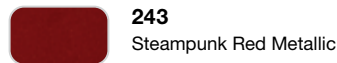

**243**  
Steampunk Red Metallic

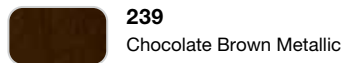

**239**  
Chocolate Brown Metallic

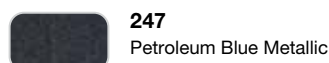

**247**  
Petroleum Blue Metallic



**241**  
Gold Metallic



**227**  
Bright Blue Metallic

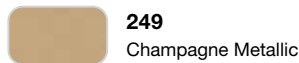

**249**  
Champagne Metallic

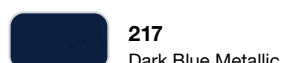

**217**  
Dark Blue Metallic



243 Steampunk Red Metallic

7125 Series	7125 Series
Size	Size
15" x 10 yard	15" x 50 yard
24" x 10 yard	24" x 50 yard
30" x 10 yard	30" x 50 yard
48" x 10 yard	48" x 50 yard

7175 Punched Series	7175 Punched Series
Size	Size
15" x 10 yard	15" x 50 yard
30" x 10 yard	30" x 50 yard



### 3M™ Products

3M Products can **ONLY** be distributed to customers in the United States and US Territories.

**Note: Punched film is only available in 15" & 30" - use part number 7175.**

**Note: Colors shown are approximate.**

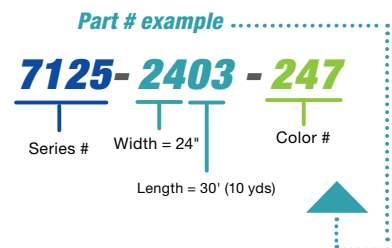

Metallic Cut Vinyl



# 3M™ Scotchcal™ ElectroCut™ Cast Film Series 7725

This series has all the same great color options, outdoor durability and conformability as the 7125 series. The big difference with this series is the synthetic liner that resists moisture absorption and static build-up, making it easier to cut and weed letters as small as 1/4".

**3M** Authorized Distributor

**(For unpunched material, start the part number with 7725, for punched use 7775.)**

**FILM THICKNESS:** 2.0 mil Cast PVC  
**FINISH:** Gloss  
**OUTDOOR DURABILITY:** 8 Years  
**ADHESIVE/COLOR:** Permanent/Clear  
**LINER:** Transparent Synthetic  
**CONFORMABILITY:** Flat surfaces, with or without Rivets, Simple Curves

- |  |  |   |
|--|--|---|
|  <b>120</b><br>Satin Aluminum           |  <b>241</b><br>Gold Metallic      |  <b>243</b><br>Steampunk Red Metallic  |
|  <b>201</b><br>Slate Metallic           |  <b>*131</b><br>Satin Gold        |  <b>247</b><br>Petroleum Blue Metallic |
|  <b>211</b><br>Charcoal Metallic        |  <b>249</b><br>Champagne Metallic |  <b>227</b><br>Bright Blue Metallic    |
|  <b>239</b><br>Chocolate Brown Metallic |  <b>229</b><br>Copper Metallic    |  <b>217</b><br>Dark Blue Metallic      |

7725 Series		7725 Series	
Size		Size	
15" x 10 yard		15" x 50 yard	
24" x 10 yard		24" x 50 yard	
30" x 10 yard		30" x 50 yard	
48" x 10 yard		48" x 50 yard	

7775 Punched Series		7775 Punched Series	
Size		Size	
15" x 10 yard		15" x 50 yard	
30" x 10 yard		30" x 50 yard	

**3M™ Products**

3M Products can **ONLY** be distributed to customers in the United States and US Territories.

**Note: Punched film is only available in 15" & 30" - use part number 7775.**

**Note: Colors shown are approximate.**

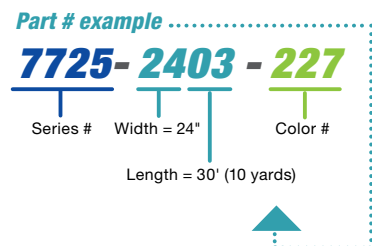

Metallic Cut Vinyl



## V4000 High Visibility Easy Apply™ RS Printable Reflective Film

If your customer is looking for a custom graphic for their reflective decals, this white printable material fits the bill. This engineer-grade reflective product prints beautifully and installs with ease because of the repositionability and air egress technology.

**FILM THICKNESS:** 7.9 mil  
**FINISH:** High Gloss  
**OUTDOOR DURABILITY:** 7 Years  
**INSTALLATION:** **DO NOT WET APPLY**

**ADHESIVE/COLOR:** Clear LTR with Gray Opacifying Layer  
**LINER:** 90# Easy Apply™ RS  
**CONFORMABILITY:** Flat, Flat with Rivets, Corrugations, Moderate Curves

V4000 White	
Film	Part No.
24" x 10 yd	A135505
24" x 50 yd	A135506
48" x 10 yd	A135507
48" x 50 yd	A135508

**Common Applications:**

- Fleet
- Striping
- Vehicle
- Railroad cars
- Bus graphics
- Indoor signage (wayfinding)
- Outdoor signage



Reflective Cut Vinyl





Authorized Distributor

## 3M™ Scotchlite™ Reflective Film Series 680

Use this long-term, durable reflective film on commercial vehicles, signs, rail cars, bus graphics and other common striping applications. This engineered reflective film will work great over corrugations or rivets and the Controltac adhesive will slide and reposition for easy installation.

**(For unpunched material, start the part number with 6800, for punched use 6850.)**

**FILM THICKNESS:** 7.0 mil Retroreflective  
**FINISH:** Gloss  
**OUTDOOR DURABILITY:** 9 Years  
**INSTALLATION:** **DRY APPLY ONLY**

**ADHESIVE/COLOR:** Pressure Activated, Slidable/Clear Permanent  
**LINER:** Polyethylene-coated Layflat  
**CONFORMABILITY:** Vertical, Flat, Curved or Corrugated Surfaces, with or without Rivets

 <b>010</b> White	 <b>091</b> School Bus Yellow	 <b>076</b> Light Blue
 <b>085</b> Black	 <b>014</b> Orange	 <b>077</b> Green
 <b>064</b> Gold	 <b>072</b> Red	
 <b>071</b> Yellow	 <b>082</b> Ruby Red	
 <b>081</b> Lemon Yellow	 <b>075</b> Blue	

### Common Applications:

- Vehicle Markings
- Striping
- Emblems
- Bumper Stickers
- Railroad Graphics
- Signs

Reflective Cut Vinyl

6800 Series	6800 Series
Size	Size
15" x 10 yard	15" x 50 yard
24" x 10 yard	24" x 50 yard
30" x 10 yard	30" x 50 yard
48" x 10 yard	48" x 50 yard

6850 Punched Series	6850 Punched Series
Size	Size
15" x 10 yard	15" x 50 yard
30" x 10 yard	30" x 50 yard

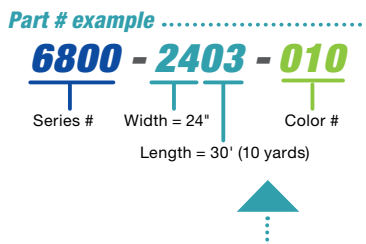

**Note: Punched film is only available in 15" & 30" - use part number 6850.**

**Note: This series is Gerber punched.**

**Note: Colors shown are approximate.**

### 3M™ Products

3M Products can **ONLY** be distributed to customers in the United States and US Territories.



# 3M™ Scotchlite™ Removable Reflective Film with Comply™ Adhesive Series 680CR



Authorized Distributor

Reflective films can be difficult to apply, however, this premium series comes with the 3M ControlTac™ and Comply™, slideable adhesive. Apply this film on displays, signs, public transport vehicles, trucks and trailers, etc. This pressure-activated film also applies exceptionally well as a result of the air-release channels in the adhesive for bubble-free graphic installation. Choose this film when you have a long-term application or a surface with complex curves or rivets.

**(For unpunched material, start the part number with 6801, for punched use 6851.)**

**FILM THICKNESS:** 7.0 mil Retroreflective  
**FINISH:** Gloss  
**OUTDOOR DURABILITY:** 9 Years  
**INSTALLATION:** **DRY APPLY ONLY**

**ADHESIVE/COLOR:** Removable Pressure Activated and Slideable with Air Release Channels/Clear  
**LINER:** Polyethylene-Coated Layflat  
**CONFORMABILITY:** Vertical, Flat, Curved or Corrugated Surfaces, with or without Rivets

<b>010</b> White	<b>071</b> Yellow	<b>072</b> Red	<b>076</b> Light Blue
<b>085</b> Black	<b>081</b> Lemon Yellow	<b>082</b> Ruby Red	<b>077</b> Green
<b>064</b> Gold	<b>014</b> Orange	<b>075</b> Blue	

6801 Series	6801 Series
Size	Size
15" x 10 yard	15" x 50 yard
24" x 10 yard	24" x 50 yard
30" x 10 yard	30" x 50 yard
48" x 10 yard	48" x 50 yard

6851 Punched Series	6851 Punched Series
Size	Size
15" x 10 yard	15" x 50 yard
30" x 10 yard	30" x 50 yard



Reflective Cut Vinyl

APPLICATIONS		Series 680CR
Vehicle Graphics	Flat or Flat with Rivets	✓
	Corrugations with Rivets	✓
Vehicle Markings		✓
Striping		✓
Emblems		✓
Bumper Stickers		✓
Railroad Graphics		✓
Signs		✓

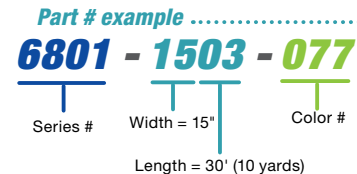

### 3M™ Products

3M Products can **ONLY** be distributed to customers in the United States and US Territories.

**Note: Punched film is only available in 15" & 30" - use part number 6851.**

**Note: This series is Gerber punched.**

**Note: Colors shown are approximate.**



Authorized Distributor

# 3M™ Scotchlite™ Reflective Film Series 5100R

This removable reflective film is an excellent choice for non-regulated commercial signage. Often used for flat vehicle markings, general purpose signage and non-critical road signs such as parkways or wayfinding signs. Ideal for short to mid-term graphics.

**(For unpunched material, start the part number with 5101, for punched use 5151.)**

**FILM THICKNESS:** 7.0 mil Retroreflective  
**FINISH:** Gloss  
**OUTDOOR DURABILITY:** 7 Years  
**INSTALLATION:** **DRY APPLY ONLY**

**ADHESIVE/COLOR:** Removable/Clear (Removable up to 3 years)  
**LINER:** Polyethylene Coated Layflat  
**CONFORMABILITY:** Vertical, Flat, Curved or Corrugated Surfaces, with or without Rivets

<b>010</b> White	<b>081</b> Lemon Yellow	<b>074</b> Royal Purple	<b>078</b> Light Green
<b>064</b> Gold	<b>014</b> Orange	<b>075</b> Blue	<b>079</b> Brown
<b>065</b> Rich Gold	<b>072</b> Red	<b>076</b> Light Blue	<b>085</b> Black
<b>071</b> Yellow	<b>082</b> Ruby Red	<b>077</b> Green	

Reflective Cut Vinyl

5101 Series	5101 Series
Size	Size
15" x 10 yard	15" x 50 yard
24" x 10 yard	24" x 50 yard
30" x 10 yard	30" x 50 yard
48" x 10 yard	48" x 50 yard

5151 Punched Series	5151 Punched Series
Size	Size
15" x 10 yard	15" x 50 yard
30" x 10 yard	30" x 50 yard

APPLICATIONS		Series 5100R
Vehicle Graphics	Flat or Flat with Rivets	✓
	Corrugations with Rivets	
Vehicle Markings		✓
Striping		✓
Emblems		✓
Bumper Stickers		✓
Railroad Graphics		
Signs		✓

**3M™ Products**

3M Products can **ONLY** be distributed to customers in the United States and US Territories.

**Note: Punched film is only available in 15" & 30" - use part number 5151.**

**Note: This series is Gerber punched.**

**Note: Colors shown are approximate.**

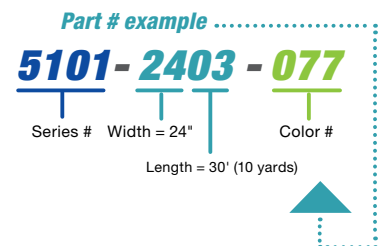





## Avery Dennison® SF 100 Paint Mask Film 128 & 231, Removable Adhesive

Create a stencil with your cutter for your painted work that requires fine lines and details. You can also use this film to protect large areas that may be subject to overspray during the painting process. This film is formulated with a strong removable adhesive that will remove cleanly from OEM painted surfaces. Designed for flat surfaces and comes in two different colors.

**FILM THICKNESS:** 3.4 mil Calendered    **ADHESIVE/COLOR:** Removable/Clear    **INSTALLATION:** DRY APPLY ONLY  
**FINISH:** Matte    **LINER:** 78# Kraft  
**DURABILITY:** 1 Year    **CONFORMABILITY:** Flat Surfaces



White

SF100-128 Paint Mask - Punched	
Size	Part No.
15" x 10 yd	A000247
15" x 50 yd	A000248
30" x 10 yd	A000249
30" x 50 yd	A000251
SF100-128 Paint Mask - Unpunched	
Film	Part No.
15" x 50 yd	A000250
24" x 10 yd	A000252
24" x 50 yd	A000253
30" x 50 yd	A000255
48" x 10 yd	A000256
48" x 50 yd	A000259



Yellow

SF100-231 Paint Mask - Punched	
Size	Part No.
15" x 10 yd	A000273
15" x 50 yd	A000274
30" x 10 yd	A000275
30" x 50 yd	A000277
SF100-231 Paint Mask - Unpunched	
Size	Part No.
15" x 50 yd	A000276
24" x 10 yd	A000278
24" x 50 yd	A000279
30" x 50 yd	A000281
48" x 10 yd	A000282
48" x 50 yd	A000285



**Note: Punched film is only available in 15" & 30"**  
**Note: Colors shown are approximate.**



**Note: Punched film is only available in 15" & 30"**  
**Note: Colors shown are approximate.**

## Avery Dennison® SF 100 Paint Mask High Temp Film 235, Removable Adhesive

When your custom paint job requires a baking cycle, you need this film. This material bonds well to OEM painted surfaces and will remove cleanly when you're done. The baking cycle should not exceed 200°F.

**FILM THICKNESS:** 3.2 mil Calendered    **ADHESIVE/COLOR:** High Tack Removable/Clear    **INSTALLATION:** DRY APPLY ONLY  
**FINISH:** Matte    **LINER:** 78# Kraft  
**DURABILITY:** 1 Year    **CONFORMABILITY:** Flat surfaces



Yellow

SF100-235 Paint Mask - Punched	
Size	Part No.
15" x 10 yd	A000312
15" x 50 yd	A000313
30" x 10 yd	A000314
30" x 50 yd	A000316

SF100-235 Paint Mask - Unpunched	
Size	Part No.
15" x 50 yd	A000315
24" x 10 yd	A000317
24" x 50 yd	A000318
30" x 50 yd	A000320
48" x 10 yd	A000321
48" x 50 yd	A000324



**Note: Punched film is only available in 15" & 30"**  
**Note: Colors shown are approximate.**



**Avery Dennison® Products**  
 Avery Dennison® Products can ONLY be distributed to customers in the United States and US Territories.

Specialty Cut Vinyl



## Lumina™ Static Cling Film Series 7262

Static cling is a great option for short term graphics. You don't need to fuss with adhesive because the film's thick, soft texture can be positioned, repositioned and removed from glass with ease. We offer this in both white and clear printable film.

**(Remember to select the right color code for punched and unpunched film.)**

<b>FILM THICKNESS:</b> 7.5 mil Calendered	<b>ADHESIVE/COLOR:</b> N/A
<b>FINISH:</b> White/Clear	<b>LINER:</b> 8 pt. board
<b>OUTDOOR DURABILITY:</b> 3 Months	<b>CONFORMABILITY:</b> Flat Surfaces

**000**  
Gloss Clear

**002**  
Gloss White

**050**  
Gloss Clear  
(Punched)

**052**  
Gloss White  
(Punched)

7262 Series Unpunched Size
30" x 25 yard
60" x 25 yard

7262 Series Unpunched Size
30" x 50 yard
60" x 50 yard

7262 Series Punched Size
15" x 25 yard
15" x 50 yard



**Note: Punched film is only available in 15"**

**Note: Colors shown are approximate.**

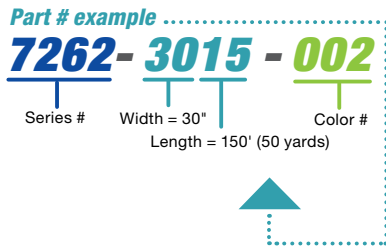

Specialty Cut Vinyl



### 3M™ Scotchcal™ ElectroCut™ Film Series 7725SE

You'll really impress your customers with these incredibly unique etched glass films. For a softer, smoother look try the dusted crystal finish. If you need a little more sparkle then you'll fall in love with the frosted finish. These films will cut cleanly and provide exceptional stability for years to come. Use a thicker transfer tape if you're having trouble getting smaller details to lift off the liner.



Authorized Distributor

**(For unpunched material, start the part number with 7725, for punched use 7775.)**

**FILM THICKNESS:** Dusted - 3.2 mil - Frosted - 4.7 mil/Cast  
**FINISH:** Dusted/Frosted  
**OUTDOOR DURABILITY:** 3 Years

**ADHESIVE/COLOR:** Permanent/Clear  
**LINER:** Transparent Synthetic  
**CONFORMABILITY:** Flat Surfaces

**314**  
Dusted  
Crystal



**324**  
Frosted  
Crystal

**7725SE - Use 7725 for Part Number**  
Size

15" x 10 yard
24" x 10 yard
30" x 10 yard
48" x 10 yard
60" x 10 yard

**7725SE - Use 7725 for Part Number**  
Size

15" x 50 yard
24" x 50 yard
30" x 50 yard
48" x 50 yard
60" x 50 yard

**7775SE Punched - Use 7775 for Part Number**  
Size

15" x 10 yard
30" x 10 yard

**7775SE Punched - Use 7775 for Part Number**  
Size

15" x 50 yard
30" x 50 yard



Specialty Cut Vinyl

*Printable etched glass film found on page 25*

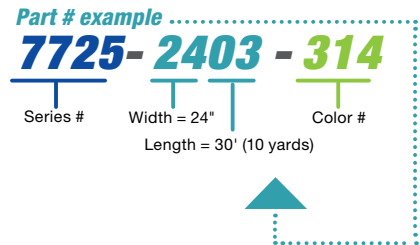

**Note: Punched film is only available in 15" & 30" - use part number 7775.**  
**Note: Colors shown are approximate.**

**3M™ Products**

3M Products can **ONLY** be distributed to customers in the United States and US Territories.





## RTape® VinylEfx® Metal Decorative Series

Add the look of metal to indoor signs with the help of this decorative metallized PVC film. This film is designed to be extremely stable during the converting process. Add a pop of color by layering other cut vinyl or print directly to the surface of this film. This film is sure to impress your customers and set you apart from your competition.

**(For unpunched material, start the part number with 2826, for punched use 2876.)**

**FILM THICKNESS:** 3.0 mil Metallized PVC  
**FINISH:** Gloss  
**ADHESIVE/COLOR:** Permanent/Clear  
**LINER:** 88# Layflat  
**CONFORMABILITY:** Flat Surfaces



**004**  
Florentine Leaf Gold



**104**  
Smooth Mirror Gold



**207**  
Fine Brushed Silver



**107**  
Smooth Mirror Silver

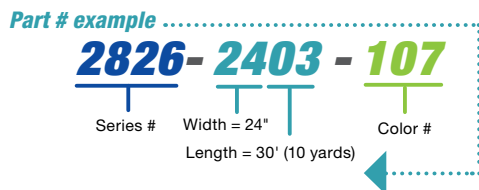

**Note: Punched film is only available in 15" - use part number 2876.**

**Note: Colors shown are approximate.**

Series 2826 - Florentine Leaf Gold (004)	
Size	Size
15" x 10 yard	15" x 50 yard
24" x 10 yard	24" x 50 yard

Series 2876 Punched - Florentine Leaf Gold (004)	
Size	Size
15" x 10 yard	15" x 50 yard

Series 2826 - Smooth Mirror Gold (104)	
Size	Size
15" x 10 yard	15" x 50 yard
24" x 10 yard	24" x 50 yard
48" x 10 yard	48" x 50 yard

Series 2876 Punched - Smooth Mirror Gold (104)	
Size	Size
15" x 10 yard	15" x 50 yard

Series 2826 - Silver (107, 207)	
Size	Size
15" x 10 yard	15" x 50 yard
24" x 10 yard	24" x 50 yard
48" x 10 yard	48" x 50 yard

Series 2876 Punched - Silver (107, 207)	
Size	Size
15" x 10 yard	15" x 50 yard

## RTape® VinylEfx® Metal Flake Decorative Series

Add eye-catching special effects to your graphics with this metallized PVC film. This film produces a unique finish that is only available with this technology. As a decorative series, this is only intended for flat, indoor applications.

**(For unpunched material, start the part number with 2824, for punched use 2874.)**

**FILM THICKNESS:** 3.0 mil Metallized PVC  
**FINISH:** Gloss  
**ADHESIVE/COLOR:** Permanent/Clear  
**LINER:** 88# Layflat  
**CONFORMABILITY:** Flat Surfaces  
**LAMINATE:** Cold  
**INSTALLATION:** **DRY APPLY ONLY**

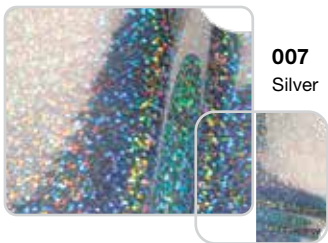

**007**  
Silver

Series 2824 - Silver	
Size	Width x Length
15" x 10 yard	15" x 50 yard
24" x 10 yard	24" x 50 yard
48" x 10 yard	48" x 50 yard

Series 2874 Punched - Silver	
Size	Width x Length
15" x 10 yard	15" x 50 yard

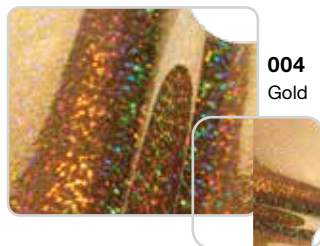

**004**  
Gold

Series 2824 - Gold	
Size	Width x Length
15" x 10 yard	15" x 50 yard
24" x 10 yard	24" x 50 yard

Series 2874 Punched - Gold	
Size	Width x Length
15" x 10 yard	15" x 50 yard



**Note: Punched film is only available in 15" - use part number 2874.**

**Note: Colors shown are approximate.**



# RTape® VinylEfx® Metal Outdoor Durable

Now you can use the technology of metallized PVC to create unique outdoor graphics that look like metal! This film has a special coating that is designed for enhanced outdoor durability and is printable, adding even more versatility. This series offers several finishes that are sure to impress your customers. Use for flat promotional graphics, signs and decals.

**(For unpunched material, start the part number with 4826, for punched use 4876.)**

**FILM THICKNESS:** 3.0 mil Metallized PVC  
**FINISH:** Gloss  
**OUTDOOR DURABILITY:** 3 Years

**ADHESIVE/COLOR:** Permanent/Clear  
**LINER:** 88# Layflat  
**CONFORMABILITY:** Flat Surfaces and Simple Curves

**LAMINATE:** Cold  
**INSTALLATION:** DRY APPLY ONLY



**004**  
Florentine  
Leaf Gold

* 4826 Florentine	
Size	Size
15" x 10 yard	15" x 50 yard
24" x 10 yard	24" x 50 yard

* 4876 Punched - Florentine
Size
15" x 10 yard
15" x 50 yard



**107**  
Smooth  
Mirror Silver

* 4826 Smooth Mirror Silver	
Size	Size
15" x 10 yard	15" x 50 yard
24" x 10 yard	24" x 50 yard
30" x 10 yard	30" x 50 yard
48" x 10 yard	48" x 50 yard

* 4876 Punched - Smooth Mirror Silver
Size
15" x 10 yard
15" x 50 yard
30" x 10 yard
30" x 50 yard



**207**  
Fine  
Brushed  
Silver

4826 Fine Brushed Silver	
Size	Size
15" x 10 yard	15" x 50 yard
24" x 10 yard	24" x 50 yard
30" x 10 yard	30" x 50 yard
48" x 10 yard	48" x 50 yard

4876 Punched - Fine Brushed Silver
Size
15" x 10 yard
15" x 50 yard
30" x 10 yard
30" x 50 yard



**104**  
Smooth  
Mirror Gold

* 4826 Smooth Mirror Gold	
Size	Size
15" x 10 yard	15" x 50 yard
24" x 10 yard	24" x 50 yard
48" x 10 yard	48" x 50 yard

* 4876 Punched - Smooth Mirror Gold
Size
15" x 10 yard
15" x 50 yard



**204**  
Fine  
Brushed  
Gold

* 4826 Fine Brushed Gold & Large Engine Turn Gold	
Size	Size
15" x 10 yard	15" x 50 yard
24" x 10 yard	24" x 50 yard
48" x 10 yard	48" x 50 yard

* 4876 Punched - Fine Brushed Gold & Large Engine Turn Gold
Size
15" x 10 yard
15" x 50 yard



**041**  
Large  
Engine  
Turn Gold

\* Not recommended for all plastics. Please test before use.

Note: Punched film is only available in 15" & 30" - use part number 4876.

Note: Colors shown are approximate.



Part # example

**4826-2403-207**

Series #    Width = 24"    Length = 30' (10 yards)    Color #

Specialty Cut Vinyl



## VinylEfx® Diamond Plate Decorative & Outdoor Durable

This metallized PVC film simulates the look of diamond plated metal. You'll be amazed by the amount of detail this film provides. Applied to the right surface, you won't be able to tell it's not real diamond plating. Add printed graphics to the surface for additional detail that will impress your customer. The 4827 series film comes with a coating that provides more durability for outdoor applications. **(For decorative unpunched material, start the part number with 2827, for punched use 2877.) (For outdoor unpunched material, start the part number with 4827, for punched use 4877.)**

**FILM THICKNESS:** 3.0 mil Metallized PVC    **ADHESIVE/COLOR:** Permanent/Clear    **LAMINATE:** Cold  
**FINISH:** Gloss    **LINER:** 88# Layflat    **INSTALLATION:** **DRY APPLY ONLY**  
**4827 OUTDOOR DURABILITY:** Outdoor 3 Years    **CONFORMABILITY:** Flat Surfaces



**007**  
Silver

**2827 Indoor Series**

Size	Size
15" x 10 yard	15" x 50 yard
24" x 10 yard	24" x 50 yard
48" x 10 yard	48" x 50 yard

**2877 Punched Indoor Series**

Size
15" x 10 yard
15" x 50 yard

**Note: Punched film is only available in 15" - use part number 2877.**

**Note: Colors shown are approximate.**

**4827 Outdoor Series**

Size	Size
15" x 10 yard	15" x 50 yard
24" x 10 yard	24" x 50 yard
48" x 10 yard	48" x 50 yard

**4877 Punched Outdoor Series**

Size
15" x 10 yard
15" x 50 yard

**Note: Punched film is only available in 15" - use part number 4877.**

**Note: Colors shown are approximate.**



Specialty Cut Vinyl

## VinylEfx® ChalkTalk®

Make your graphic new every day with this non-PVC film coated with a repositionable and removable adhesive. The grainy texture provides the perfect finish for writing and drawing with chalk. Suggest this film for restaurant menu boards or a unique applique in a home environment. Wipe the film clean with an eraser, damp towel or sponge.

**FILM THICKNESS:** 5.0 mil    **LINER:** 90# Layflat  
**FINISH:** Matte    **CONFORMABILITY:** Flat Surfaces  
**ADHESIVE/COLOR:** Removable/Clear    **INSTALLATION:** **DRY APPLY ONLY**



**040**  
Black



**4310 Series - Black**

Size
24" x 25 yard
54" x 25 yard

**Note: Color shown are approximate.**







## Transfer Tape



Low Tack

### TransferRite® Ultra® 560U Low Tack Transfer Tape

**FILM THICKNESS:** 4.0 mil Standard Paper  
**ADHESIVE/COLOR:** Ultra Low Tack/White

This is a general-purpose low tack transfer tape that works great for large digitally printed graphics. You can also use this material as a masking. The ULTRA adhesive technology bonds to the exposed liner reducing "edge curl."

- Can be lasered.
- Installs easily and removes cleanly with ease.
- Label on the inside of the core has a green "L" to indicate low tack adhesive.

TransferRite®  
**ULTRA®**

#### TransferRite Ultra 560U Low Tack

Size	Part #
24" x 100 yard	<b>560U24</b>
48" x 100 yard	<b>560U48</b>
54" x 100 yard	<b>560U54</b>
60" x 100 yard	<b>560U60</b>

### TransferRite® Ultra® 582U Medium Tack Transfer Tape

**FILM THICKNESS:** 4.0 mil Standard Paper  
**ADHESIVE/COLOR:** Ultra Medium Tack/White

- Ideal for general use.
- The "Ultra" backing makes these tapes ideal for RTA (Ready-to-Apply) decals.
- Tape lays flat reducing wrinkling, tunneling and edge lifting during storage.
- Waterbased rubber adhesive adheres to smooth liners.
- Can be lasered.
- Label on the inside of the core has a yellow "M" to indicate medium tack adhesive.



Medium Tack

#### TransferRite Ultra 582U Medium Tack

Size	Part #
6" x 100 yard	<b>582U6</b>
12" x 100 yard	<b>582U12</b>
24" x 100 yard	<b>582U24</b>
30" x 100 yard	<b>582U30</b>
48" x 100 yard	<b>582U48</b>

### TransferRite® Ultra® 592U High Tack Transfer Tape

**FILM THICKNESS:** 4.0 mil Standard Paper  
**ADHESIVE/COLOR:** Ultra High Tack/ White

- Ideal for use with intermediate or calendared films.
- Specially purposed for projects with smaller letters and graphics.
- The "Ultra" backing makes these tapes ideal for RTA (Ready-to-Apply) decals.
- Tape lays flat reducing wrinkling, tunneling and edge lifting during storage.
- Waterbased rubber adhesive adheres to smooth liners.
- Can be lasered.
- Label on the inside of the core has a red "H" to indicate high tack adhesive.



High Tack

#### TransferRite Ultra 592U High Tack

Size	Part #
6" x 100 yard	<b>592U6</b>
12" x 100 yard	<b>592U12</b>
24" x 100 yard	<b>592U24</b>
30" x 100 yard	<b>592U30</b>
48" x 100 yard	<b>592U48</b>

Transfer Tape



# Transfer Tape

**TransferRite®  
ULTRA®**



## TransferRite® Ultra® 1320 High Tack Transfer Film



**FILM THICKNESS:** 4.0 mil Film Backing  
**ADHESIVE/COLOR:** High Tack/Clear

This transfer tape is made of a synthetic material that allows you to see the vinyl during the transfer process. The high tack adhesive is needed when weeding fine detail or thicker films such as reflective or special effect vinyl films like etched glass or metallized PVC films. The ULTRA adhesive technology bonds to the exposed liner reducing "edge curl." Tape lays flat reducing wrinkling and tunneling during storage

TransferRite Ultra 1320 High Tack	
Size	Part #
6" x 100 yard	<b>13206</b>
12" x 100 yard	<b>132012</b>
24" x 100 yard	<b>132024</b>
48" x 100 yard	<b>132048</b>

## TransferRite® Ultra® 794U High Tack Transfer Tape



**FILM THICKNESS:** 5.0 mil Premium Paper  
**ADHESIVE/COLOR:** High Tack/White

High tack transfer paper that utilizes a thicker, premium paper paired with a high tack adhesive. Sign builders choose this tape when working with reflective films or etched glass films that can be tough to lift from the liner. Utilize this film when rolling, shipping or storing graphics for an extended period of time. The tape's heavy weight paper provides dimensional stability and resists humidity. Excellent for applying vinyl striping and bonds well to smooth liners, reducing "edge curl."

TransferRite Ultra 794U	
Size	Part #
48" x 100 yard	<b>794U48</b>

Transfer Tape



TransferRite®  
**ULTRA®**

## Transfer Tape



### TransferRite® Ultra® Clear 1310 Medium Tack Transfer Film

**FILM THICKNESS:** 4.0 mil Clear Polypropylene  
**ADHESIVE/COLOR:** Ultra Medium Tack/Clear

This transfer tape is made of a synthetic material that allows you to see the vinyl during the transfer process. The medium tack adhesive is needed when weeding mid-sized graphics. The ULTRA adhesive technology bonds to the exposed liner reducing "edge curl."

- Tape lays flat reducing wrinkling and tunneling during storage.
- Ideal for general use or multi-color overlays.
- Easily releases from substrates.
- Snap to tear the tape.

#### TransferRite Ultra Clear 1310 Medium Tack

Size	Part #
12" x 100 yard	<b>131012</b>
16" x 100 yard	<b>131016</b>
24" x 100 yard	<b>131024</b>
30" x 100 yard	<b>131030</b>
48" x 100 yard	<b>131048</b>
54" x 100 yard	<b>131054</b>



### TransferRite® Ultra® Clear 310G With Grid Medium Tack Transfer Film

**FILM THICKNESS:** 4.0 mil Clear Polypropylene  
**ADHESIVE/COLOR:** Ultra Medium Tack/Clear

The same great tape as the 1310 only now you have a printed grid pattern for registration. The grid pattern provides a straight point of reference for aligning graphics during installation. Made of a synthetic material, you can see the vinyl clearly during the transfer process. The medium tack adhesive is needed when weeding mid-sized graphics. The ULTRA adhesive technology bonds to the exposed liner reducing "edge curl."

- Tape lays flat reducing wrinkling and tunneling during storage.
- Ideal for general use or multi-color overlays.
- Easily releases from substrates.
- Snap to tear.

#### TransferRite Ultra Clear 310G Medium Tack

Size	Part #
6" x 100 yard	<b>310G6</b>
8" x 100 yard	<b>310G8</b>
16" x 100 yard	<b>310G16</b>
24" x 100 yard	<b>310G24</b>
48" x 100 yard	<b>310G48</b>



### AirMask® 510U Clear Film Premask

**FILM THICKNESS:** 4.3 mil Clear Polypropylene Film Backing  
**ADHESIVE/COLOR:** Latex Pressure Sensitive/Clear

The AirMask® transfer film is the only option to reduce the unavoidable "edge curl" common with air egress films. This tape will adhere and remain flat when applied to air egress liners.

- Fully adheres to air egress liners.
- Works well with difficult color change films and textured wrap films.
- Cold apply to film with a laminator for best results.
- Installs easily and removes cleanly with ease.

#### AirMask 510U Clear Film Premask Medium Tack

Size	Part #
24" x 100 yard	<b>510U24</b>
48" x 100 yard	<b>510U48</b>
54" x 100 yard	<b>510U54</b>

Transfer Tape





# Transfer Tape



Transfer Tape

## **RTape® AT65 Clear Choice® High Tack, Transfer Film**

When you're transferring graphics that require multiple colors of cut vinyl, you need to see what you're doing. As a high tack film, this clear transfer film will offer exceptional clarity and pick up the finest detail your plotter can cut. Transferring graphics has never been easier.

**FILM THICKNESS:** 3.5 mil Clear Polypropylene  
**FINISH:** Matte

**ADHESIVE/COLOR:** High Tack Removable/Clear  
**CONFORMABILITY:** Conforms to Most Surfaces



AT65 Clear Choice® High Tack, Application Tape	
Size	2667 Series Part #
6 1/2" x 100 yard	<b>2667-0630-000</b>
8 1/2" x 100 yard	<b>2667-0830-000</b>
12" x 100 yard	<b>2667-1229-000</b>
16" x 100 yard	<b>2667-1630-000</b>

AT65 Clear Choice® High Tack, Application Tape	
Size	2667 Series Part #
18" x 100 yard	<b>2667-1830-000</b>
24" x 100 yard	<b>2667-2430-000</b>
30" x 100 yard	<b>2667-3030-000</b>
36" x 100 yard	<b>2667-3630-000</b>
48" x 100 yard	<b>2667-4830-000</b>

## **RTape® AT75 Clear Choice® High Tack, Transfer Film**

If you've had your film transfer tape wrinkle or stretch while applying it to a graphic then try this heavy-gauge, embossed film. This transfer tape will provide the structural integrity you need when applying and lifting the graphics off the liner. The anti-glare finish ensures you can confidently see your graphics during the entire installation process.

**FILM THICKNESS:** 5.7 mil Clear Polypropylene  
**FINISH:** Matte

**ADHESIVE/COLOR:** High Tack Removable/Clear  
**CONFORMABILITY:** Conforms to Most Surfaces



AT75 Clear Choice® High Tack, Application Tape	
Size	2659 Series Part #
2 1/4" x 100 yard	<b>2659-0230-000</b>
6 1/2" x 100 yard	<b>2659-0630-000</b>
8 1/2" x 100 yard	<b>2659-0830-000</b>
12" x 100 yard	<b>2659-1229-000</b>

AT75 Clear Choice® High Tack, Application Tape	
Size	2659 Series Part #
30" x 100 yard	<b>2659-3030-000</b>
36" x 100 yard	<b>2659-3630-000</b>
48" x 100 yard	<b>2659-4830-000</b>



## Transfer Tape

### RTape® 4000 ApliTape™ Low Tack, Transfer Tape

Use this film for masking sign faces, digital prints or metal surfaces. The low tack adhesive removes cleanly which makes transferring large cut graphics much faster.

**FILM THICKNESS:** 4.5 mil Standard Paper  
**FINISH:** Matte

**ADHESIVE/COLOR:** Low Tack Removable/Clear  
**CONFORMABILITY:** Conforms to Most Surfaces

4000 ApliTape™ Low Tack, Application Tape	
Size	2602 Series Part #
8" x 50 yard	2602-0815-002
12" x 50 yard	2602-1215-002
15" x 50 yard	2602-1515-002
24" x 50 yard	2602-2415-002
48" x 50 yard	2602-4815-002



### RTape® 4050 ApliTape™ Medium Tack, Transfer Tape

You will use this medium tack transfer tape all day, every day. The standard paper thickness combined with the medium tack adhesive makes this film a shop necessity. It also works great for wet applications.

**FILM THICKNESS:** 4.5 mil Standard Paper  
**FINISH:** Matte

**ADHESIVE/COLOR:** Medium Tack Removable/Clear  
**CONFORMABILITY:** Conforms to Most Surfaces

4050 ApliTape™ Medium Tack, Application Tape	
Size	2601 Series Part #
16" x 100 yard	2601-1630-002
18" x 100 yard	2601-1830-002
24" x 100 yard	2601-2430-002

4050 ApliTape™ Medium Tack, Application Tape	
Size	2601 Series Part #
30" x 100 yard	2601-3030-002
36" x 100 yard	2601-3630-002
48" x 100 yard	2601-4830-002



### RTape® 4075 RLA® Conform® High Tack, Transfer Tape

The high tack 4075 RLA does more than lift the smallest details in your design! The RLA stands for "Release Liner Adhesion." You can avoid the edge curling on "ready-made" graphics because this tape is designed with an adhesive that will stick to the liner. This tape is useful when working with hard to lift vinyl and wet applications.

**FILM THICKNESS:** 4.5 mil Standard Paper  
**FINISH:** Matte

**ADHESIVE/COLOR:** High Tack Removable/Clear  
**CONFORMABILITY:** Conforms to Most Surfaces

4075 RLA® Conform® High Tack, Application Tape	
Size	2614 Series Part #
2 1/4" x 100 yard	2614-0230-002
6 1/2" x 100 yard	2614-0630-002
8 1/2" x 100 yard	2614-0830-002

4075 RLA® Conform® High Tack, Application Tape	
Size	2614 Series Part #
12" x 100 yard	2614-1229-002
30" x 100 yard	2614-3030-002
36" x 100 yard	2614-3630-002
48" x 100 yard	2614-4830-002
54" x 100 yard	2614-5430-002



Transfer Tape



# KOTA<sub>PRO</sub>™

**Great quality. Very competitive prices. 100% quality guarantee.**

That's what you can expect when you purchase any Kota Pro™ product. Available exclusively from JDS Sign Supply, the Kota Pro line of products includes banner material and stands, tools, stand-offs, tapes, sign frames and heat transfer material.

Scan to learn more



**100% Quality Guarantee**







100% Quality Guarantee  
**BEST QUALITY**  
**BEST PRICE**  
100% Quality Guarantee







# Banners

*if you're looking for:*

**BANNER MATERIAL**

**POSTER MATERIAL**

**RETRACTABLE BANNER STANDS**

**GROMMETS, PRESSES & DIES**

**BANNER UPS® TAPES & BANNER TABS**



## Kota Pro™ Banner Material



**KOTA<sub>PRO</sub>**

### Kota Pro™ 13 oz. Outdoor

This outdoor grade laminated material has all the strength needed for the most common banner applications and it prints extremely well. You'll love the price point and the option of matte or gloss. NFPA 701 and CA Title 19 certified for fire resistance. **Material is wound print side in.**

3" Core  
Scrim: 9x9, 1000x1000

13 oz. Banner Front Lit Outdoor		
Film	Matte	Gloss
38" x 150 ft	KPB1041	KPB1061
54" x 150 ft	KPB1042	KPB1062
63" x 150 ft	KPB1043	KPB1063



Certified for HP Latex Inks



### Kota Pro™ 13 oz. Indoor

Choose this laminated, tear-resistant banner material for any indoor application or short term outdoor applications. You'll like how well it prints and the option to choose between a matte or gloss finish. NFPA 701 and CA Title 19 certified for fire resistance. **Material is wound print side in.**

3" Core  
Scrim: 9x9, 500x500

13 oz. Banner Front Lit		
Film	Matte	Gloss
38" x 150 ft	KPB1001	KPB1021
54" x 150 ft	KPB1002	KPB1022
63" x 150 ft	-	KPB1023



Certified for HP Latex Inks



See pages 94-99 for Kota Pro™ Banner Stands!

### Kota Pro™ 13 oz. Blockout

We redesigned the scrim in this coated material to create a smooth finish without compromising the strength. This lightweight material also has a blockout layer that provides excellent opacity so the print side remains vibrant regardless of the environment. At 13 oz. it can be used outdoors or for close up indoor applications. The matte finish will absorb any reflection. This material is NFPA 701 and CA Title 19 certified for fire resistance. **Material is wound print side in.**

3" Core  
Scrim: 36x36, 250x250

13 oz. Banner Blockout	
Film	Part No.
38" x 150 ft	KPB2021
54" x 150 ft	KPB2022
63" x 150 ft	KPB2023



Certified for HP Latex Inks



Banner Material

## Kota Pro™ Banner Material



# KOTA<sub>PRO</sub>

Certified for HP Latex Inks

### Kota Pro™ 18 oz. Double-Sided Blockout

As a coated double-sided material, this is a great tear-resistant choice for outdoor pole banners or indoor pennant style banners. The extra thickness makes the material strong and an additional blockout layer provides extra opacity for eye-catching color on both sides of the material. The super-smooth, matte finish absorbs reflection to minimize glare. The material is NFPA 701 and CA Title 19 certified for fire resistance.

**Material is double sided.**

3" Core

Scrim: 28x28, 500x500

18 oz. Double-Sided Blockout	
Film	Part No.
38" x 150 ft	KPB2001
54" x 150 ft	KPB2002
63" x 150 ft	KPB2003



**WARNING**  
CANCER AND REPRODUCTIVE HARM  
www.P65Warnings.ca.gov

### Kota Pro™ 8 oz. Mesh with Liner

This mesh material is a great option for large banner requests when overall weight can be a concern. This coated mesh material comes with a liner to keep your equipment clean while printing. An excellent option for fences, construction sites and large banners mounted to buildings. The air will easily pass through the mesh and reduce the stress on the mounting points. The material is NFPA 701 and CA Title 19 certified for fire resistance.

**Material is wound print side in.**

3" Core

Scrim: 12x12, 1000x1000

8 oz. Mesh with Liner	
Film	Part No.
38" x 150 ft	KPB3001
54" x 150 ft	KPB3002
63" x 150 ft	KPB3003



Certified for HP Latex Inks

**WARNING**  
CANCER AND REPRODUCTIVE HARM  
www.P65Warnings.ca.gov

### Kota Pro™ 13 oz. PET Gray Back

The smooth, matte finish of this laminated gray backed film makes this the optimal choice for retractable banner stands and other indoor applications. This non-curling PET (Polyethylene) provides excellent printability making this the highest quality material for close-up viewing. The material is NFPA 701 and CA Title 19 certified for fire resistance. **Material is wound print side out.**

3" Core

Scrim: None

13 oz. PET Gray Back	
Film	Part No.
38" x 150 ft	KPB4001
54" x 150 ft	KPB4002

**NON-CURLING**



Certified for HP Latex Inks

**WARNING**  
CANCER AND REPRODUCTIVE HARM  
www.P65Warnings.ca.gov

See pages 94-99 for Kota Pro™ Banner Stands!





## Poster Material



### Photo Paper

Images dry instantly and it exhibits vivid colors that will not fade on display. The secret is the super smooth coating layers that produce exceptional image quality. This photo paper features a smooth, gloss finish to compliment fine detail with striking accuracy.

**OUTDOOR DURABILITY:** N/A  
**FILM THICKNESS:** 7 mil  
**FINISH:** Gloss

**Common Applications:**

- High Resolution Graphics
- Posters
- Photos/Portraits
- Fine Art Reproduction

Photorealistic Paper	
Size	Part No.
30" x 100 ft	<b>GFP65747</b>
36" x 100 ft	<b>GFP64972</b>
54" x 100 ft	<b>GFP68037</b>



### Wet Strength Paper

This is a unique combination of durability, performance and economy. The latex saturated base paper resists humidity and creates a strong foundation for a range of indoor and outdoor applications. Featuring a print receptive coating designed to promote ink adhesion with solvent, UV and latex inkjet printers.

**OUTDOOR DURABILITY:** Temporary, Humidity Resistant  
**FILM THICKNESS:** 9 mil  
**FINISH:** Luster

**Common Applications:**

- General Posters & Signage
- Retail Advertising
- Photo Reproduction
- Wall Murals

Wet Strength Paper	
Size	Part No.
54" x 150 ft	<b>WSP67106</b>



Banner Material



## Poster Material



### Poly/Cotton Stretch Canvas

Reproduce fine art prints and photographs with this traditional stretch canvas. The material has an award-winning matte coating and prints beautifully with latex, solvent, eco-solvent or UV printers. Whether your project is large or small this material will perform well.

**OUTDOOR DURABILITY:** N/A  
**FILM THICKNESS:** 15 mil  
**FINISH:** 65% Poly / 35% Cotton

**Common Applications:**

- Art Reproductions
- Photo Reproductions
- Wall Decor

Poly/Cotton Stretch Canvas	
Size	Part No.
36" x 75 ft	GFC66027
54" x 75 ft	GFC66029
60" x 75 ft	GFC66030



### Tyvek® Banner

Use this lightweight indoor/outdoor Tyvek® banner material when you need high print quality with strength and durability. It features a subtle texture and bright white surface, with water and scratch resistant matte finish.

**OUTDOOR DURABILITY:** Short-term  
**FILM THICKNESS:** 11 mil  
**FINISH:** Matte

**Common Applications:**

- Banners
- General Posters
- General Signage

Tyvek Banner Material	
Size	Part No.
24" x 60 ft	TB22460
36" x 60 ft	TB23660

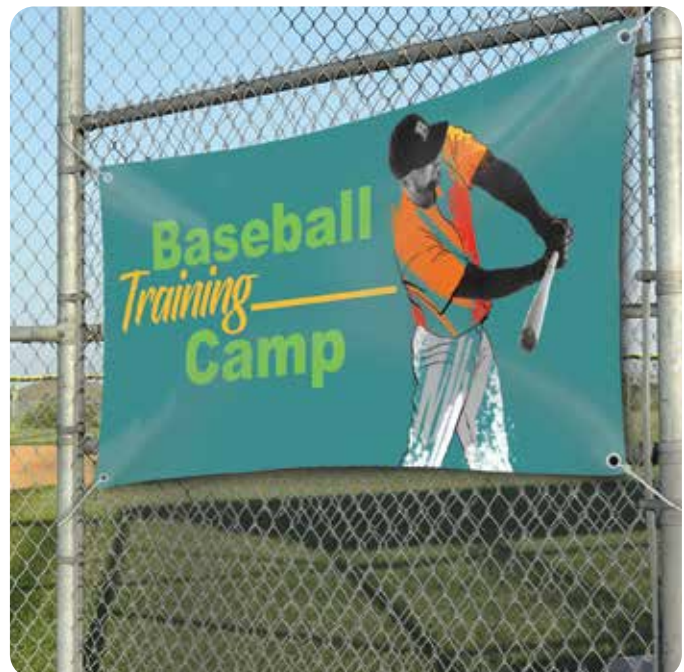

Banner Material

## Kota Pro™ Mag Pro

Use this stand in its traditional form or use the top rail inserts to connect your stands together and form a wall of graphics. The stand also provides more visibility of the inserted graphic as it comes out of the front of the stand instead of the top. Easily adjust the tension on this stand to make setting up or changing graphics a breeze. Backed by a 100% quality guarantee, trust this classic design to deliver the dependability and profitability you've come to expect from the Kota Pro brand. Designed for interior use only. **Banner material is sold separately.**

- Visible Print Dimensions: 33.5" x 29" up to 100"
- Material Dimensions: 33.5" x 106"  
6" bottom leader recommended
- Stand Dimensions: 34.5" x 100"
- Lightweight for easy transport
- Sturdy base for a strong display
- Wider, telescoping pole for improved strength
- Mounting tape included for quick installation
- Optional magnetic connectors included
- Travel Case Included

### Magnets Connect Top Rail For Side-to-Side Connectivity

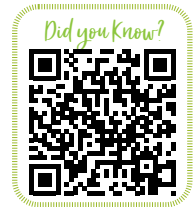

#### RUD07

34.5" Magnetic Retractable Single-Sided Banner Stand

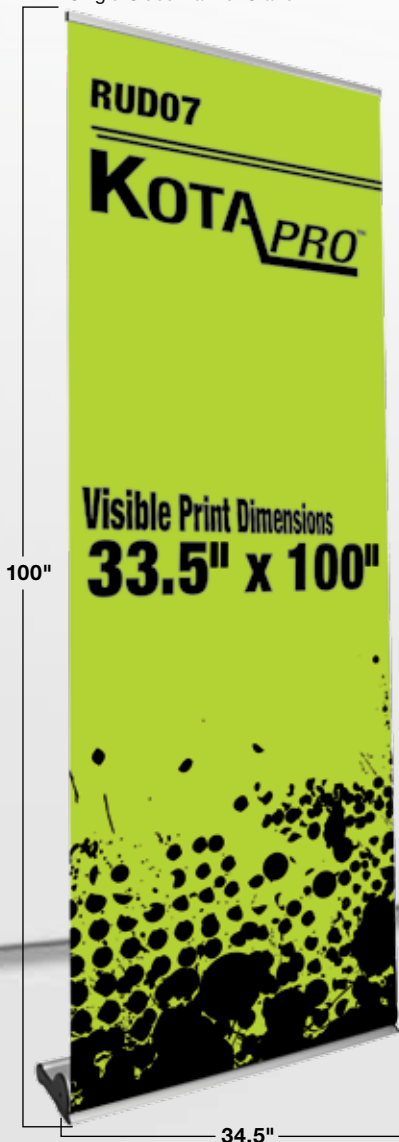

Banner Stands

Includes Travel Case with Strap



Telescoping Pole



## Kota Pro™ Deluxe 48

**KOTA**PRO™

With a professional look, this stand has a sturdy frame, rugged carrying case and two telescoping poles to firmly hold the graphic in place. The extra wide display area is perfect for any size message. Backed by a 100% quality guarantee, trust this classic design to deliver the dependability and profitability you've come to expect from the Kota Pro brand. Designed for interior use only. **Banner material is sold separately.**

- Visible Print Dimensions: 48" x 69" up to 97.5"
- Material Dimensions: 48" x 103.5"  
6" bottom leader recommended
- Stand Dimensions: 49.5" x 97.5"
- Affordable and lightweight for easy transport
- Solid base
- Two hybrid style poles for flexible graphic sizing
- Mounting tape included for quick installation
- Deluxe Travel Case Included

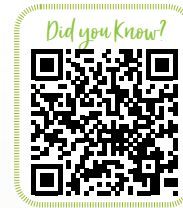

**RUD48**

48" Deluxe Retractable  
Single-Sided Banner Stand



Includes Travel Case with Strap



Telescoping Pole



Tent Style Pole



Banner Stands

See pages 90-91 for Kota Pro Banner Material!



## Kota Pro™ Cube Retractable

The Cube – a banner stand system designed to help drive sales and increase profits. The Cube delivers the ability to easily connect single-sided stands into a wide variety of configurations with two, three, four or more sides. **Banner material is sold separately.**

- Visible Print Dimensions: 33.5" x 79"
- Material Dimensions: 33.5" x 85 " 6" Bottom Leader Recommended
- Stand Dimensions: 34" x 82"
- Affordable and Lightweight for Easy Transport
- Reinforced Design for Extra Strength
- 2 Folding Feet for Improved Stability
- 3 Piece Support Pole for Stable Long Term Use
- Mounting Tape Included for Quick Installation
- Travel Case Included

**KOTA<sub>PRO</sub>**

100% Quality Guarantee  
**BEST QUALITY**  
**BEST PRICE**  
 100% Quality Guarantee

**RUD05**  
 Cube Retractable  
 Single-Sided Banner Stand



Includes Travel Case with Strap

Banner Stands

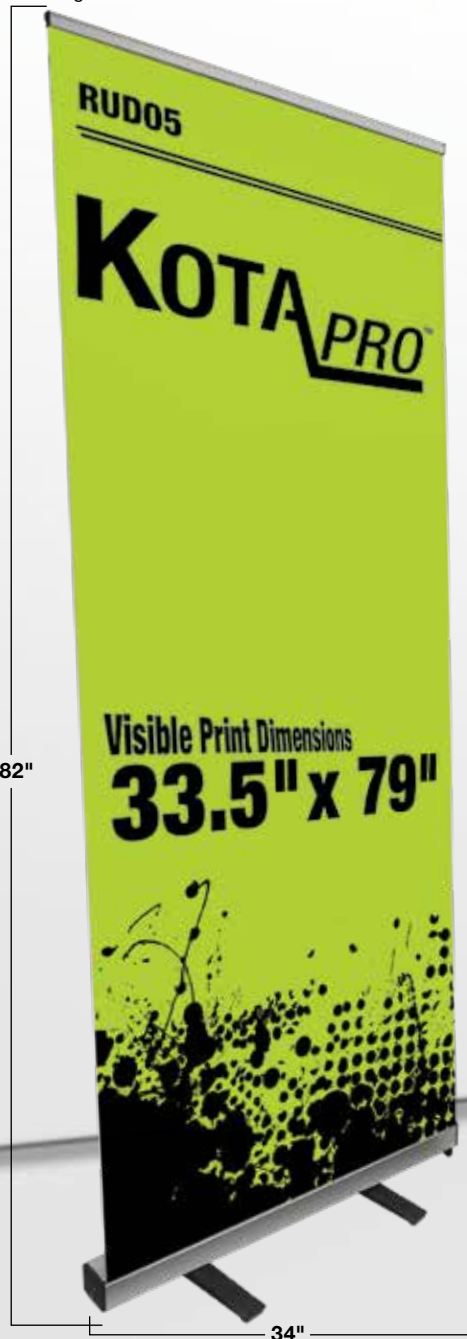

### For Back-to-Back Connectivity

**RUD05CON**  
 RUD05 Dual Stand Connector Set  
 Banner Stands Sold Separately

3-Piece Set



Pole Connector



### For Multiple Connectivity

**RUD05LINK**  
 RUD05 Link Attachment  
 Banner Stands Sold Separately

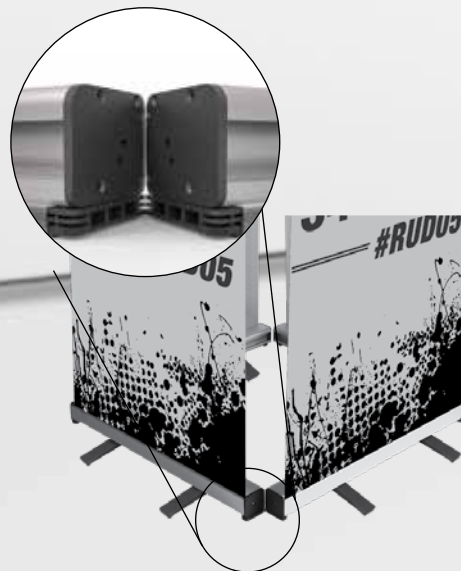

## Kota Pro™ Classic Retractable

# KOTA<sub>PRO</sub>

You can now order our most popular retractable banner stand in two different widths – 34" and 48". Backed by a 100% quality guarantee, trust this classic design to deliver the dependability and profitability you've come to expect from the Kota Pro brand. Designed for interior use only. **Banner material is sold separately.**

- Visible Print Dimensions: 33.5" x 79"
- Material Dimensions: 33.5" x 85"  
6" Bottom Leader Recommended
- Stand Dimensions: 34" x 82"
- Affordable and Lightweight for Easy Transport
- Reinforced Design for Extra Strength
- 2 Folding Feet for Improved Stability
- 3 Piece Support Pole for Stable Long Term Use
- Mounting Tape Included for Quick Installation
- Travel Case Included

- Visible Print Dimensions: 47" x 79"
- Material Dimensions: 47" x 85"  
6" Bottom Leader Recommended
- Stand Dimensions: 48" x 82"
- Affordable and Lightweight for Easy Transport
- Reinforced Design for Extra Strength
- 2 Folding Feet for Improved Stability
- 2 Tent style poles for improved stability
- Mounting Tape Included for Quick Installation
- Travel Case Included

**RUD43**  
48" Classic Retractable  
Single-Sided Banner Stand

**RUD03**  
Classic Retractable  
Single-Sided Banner Stand

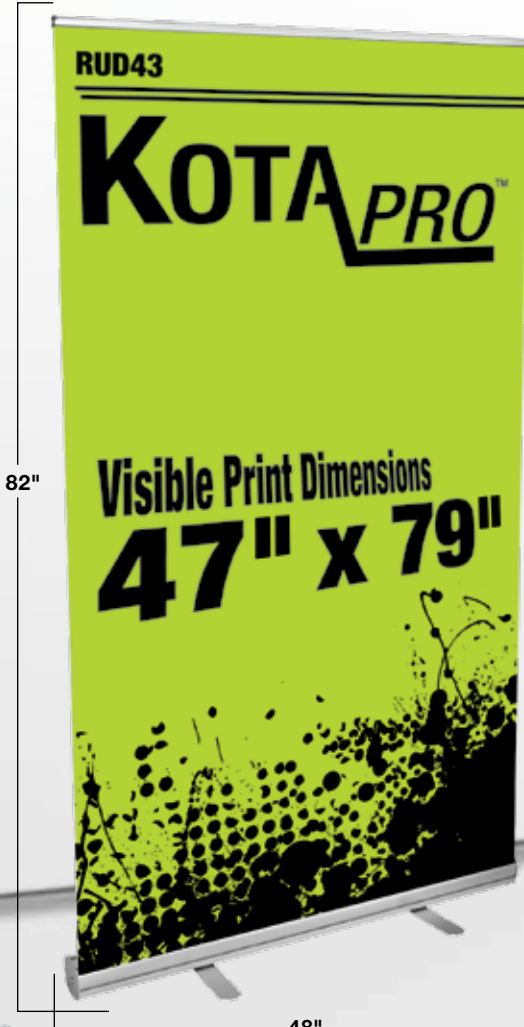

Includes Travel Case with Strap



Includes Travel Case with Strap

**See pages 90-91 for Kota Pro Banner Material!**

Banner Stands

## Kota Pro™ Deluxe Single or Double Sided

Designed to deliver a sleek, professional look at competitive prices, the Deluxe retractable banner stands from Kota Pro are lightweight, durable, and easy to break down for storage. The RUD35 and RUD36 are perfect for displays at tradeshows, in the showroom and even the boardroom. Backed by a 100% quality guarantee, Kota Pro banner stands are designed for interior use only. **Banner material is sold separately.**

- Visible Print Dimensions: 33.5" x 79"
- Material Dimensions: 33.5" x 85"  
6" Bottom Leader is Recommended
- Stand Dimensions: 35" x 82"
- Premier Design for a Sleek Professional Look
- 3-piece Support Pole for Stable Long-term Use
- Mounting Tape Included for Quick Installation
- Ends Snap Off for Fast, Convenient Installation
- Travel Case Included

**KOTA<sub>PRO</sub>**

**RUD36**  
Deluxe Double-Sided  
Banner Stand

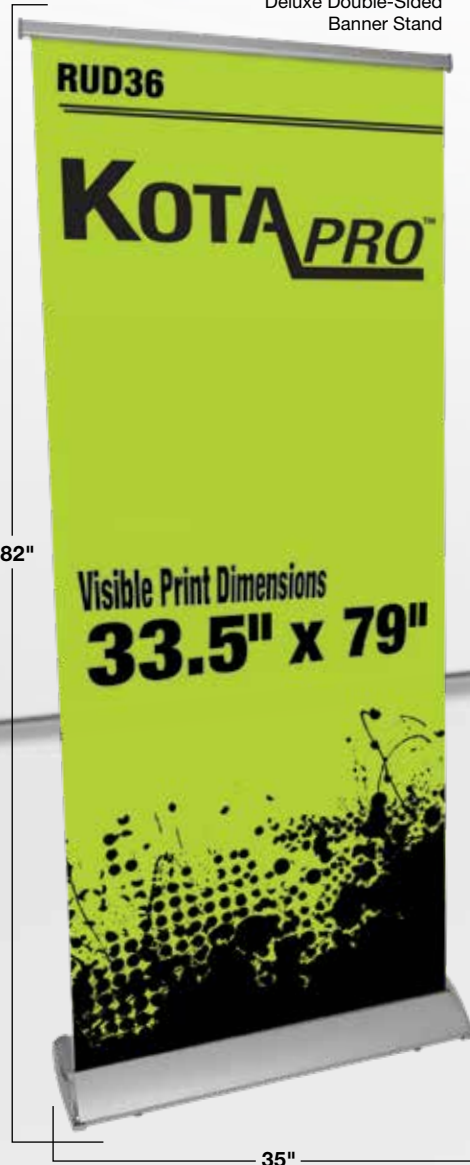

**RUD35**  
Deluxe Single-Sided  
Banner Stand



Banner Stands



# KOTA<sub>PRO</sub>

## Kota Pro™ X

Lightweight, quick to setup or take down, and easy to carry, the X banner stand from Kota Pro is an affordable option when your customer is working with a limited budget. Backed by a 100% quality guarantee, Kota Pro X banner stands are designed for interior use only. **Banner material is sold separately.**

- Stand Dimensions: 23.6" x 62.9" - 31.5" x 70.8"
- Works with Grommets: #2 - #3
- Fiberglass Poles Allow for Different Sizing Options
- Great for Showrooms or Large Display Areas
- Carrying Bag Included

• Recommended for interior use only



**XBDE1**  
Adjustable  
X Banner Stand



2 extenders add an additional 8"!



See pages 90-91 for Kota Pro Banner Material!

Banner Stands



## Hiker™ Banner Grommet Press and #2 Grommets

When it comes to hand grommet presses, the Hiker press is the best option available. The dies are interchangeable and adjustable for the perfect press, every time! The press was designed to produce up to 6 times more cutting and closing pressure than competing presses with 6 times less work. Be sure to use Hiker grommets with Hiker presses.

Grommets shown actual size.  
Grommets sold only in full packs of 500.  
For use with Hiker Presses only.



**H901**  
Grommeting Hand Press  
Forward or Backward Handle  
Case Qty: 1

- Interchangeable Die
- Adjustable Lower Die
- Professional Grade
- Inserts Eyelets as Small as 1/16" ID
- Inserts Self-piercing Grommets As Large as 5/8" ID (#5)

- Specs:
- Throat Depth: 2 3/4"
  - Height: 11"
  - Weight: 16 lbs.

**Die Sold Separately**

**HKDiE2**  
#2 Grommet Die  
Case Qty: 1



**GROMB2**  
#2 Brass Self-Piercing  
Grommet with Flat Washer  
Case Qty: 500



**GROMN2**  
#2 Nickel Self-Piercing  
Grommet with Flat Washer  
Case Qty: 500



**GROMBK2**  
#2 Black Brass Self-Piercing  
Grommet with Flat Washer  
Case Qty: 500



**GROMW2**  
#2 White Brass Self-Piercing  
Grommet with Flat Washer  
Case Qty: 500



**GROMSS2**  
#2 Stainless Steel Self-Piercing  
Grommet with Flat Washer  
Case Qty: 500

Size: #2  
ID: 3/8"  
OD: 3/4"  
LUF: 3/16"

ID = Inside Diameter  
OD = Outside Diameter  
LUF = Length Under Flange

## Hiker Press Kits

Buy the press, die and a bag of grommets all in one kit.  
Choose between brass or nickel grommets and you're ready to go.

### Brass Grommet Kit

**H901KiTB2**  
Includes:

- H901 Grommeting Hand Press
- HKDiE2 #2 Die
- GROMB2 (500) #2 Brass Self-Piercing Grommet with Flat Washer

### Nickel Grommet Kit

**H901KiTN2**  
Includes:

- H901 Grommeting Hand Press
- HKDiE2 #2 Die
- GROMN2 (500) #2 Nickel Self-Piercing Grommet with Flat Washer



## BravoTabs®

BravoTabs® are large clear square tabs for outdoor and indoor use. These tabs can be used anywhere on a banner in place of standard metal grommets.

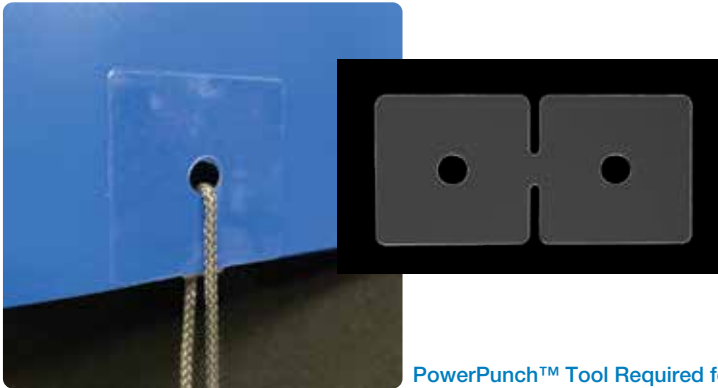

**BAN017**  
Clear BravoTabs®  
Size: 4" x 2"  
100 Pack

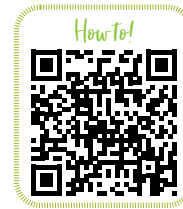

PowerPunch™ Tool Required for BravoTabs®

## PowerPunch™

PowerPunch™ is a hole punch for banners and coroplast. Can cut substrates up to 4 mm thick.



**PPUNCH**  
Creates 5/16" Hole



### STARTKT4AS2

- Starter Kit  
Includes:
- 100 Pack Clear BravoTabs®
  - 1 EZPUNCH
  - 1 Roll Clear PowerTape (36 yards)

## EZPunch™

EZPunch™ is a lightweight "Little Brother" to the PowerPunch™. For banner material only.



**EZPUNCH**  
Creates 5/16" Hole

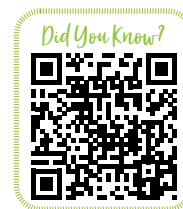

## Adhesive Grommet Tabs

The "home plate" shaped tab is good for vertical and horizontal or 45 degree corner mount. Designed with foam adhesive, they are ideal for media with a rough surface.



**BAN001**  
Large, White, with Neck Loop  
Size: 5 3/4" x 2"  
100 Pack



**BAN002**  
Mini, White, No Neck Loop  
Size: 2 1/2" x 1 1/2"  
100 Pack



**BAN003**  
Mini, Clear, No Neck Loop  
Size: 2 1/2" x 1 1/2"  
100 Pack







### PowerTabs®

PowerTabs® The triangular shape is for corners only, good for indoor or outdoor banners.



**BAN012**  
Mini, White, No Neck Loop  
Size: 3" x 1 1/2"  
100 Pack



**BAN011**  
Large, White, with Neck Loop  
Size: 5 9/16" x 2 1/8"  
100 Pack



**BAN013**  
Mini, Clear, No Neck Loop  
Size: 3" x 1 1/2"  
100 Pack



**BAN014**  
Large, Clear, with Neck Loop  
Size: 5 9/16" x 2 1/8"  
100 Pack



**BAN016**  
Large, Crystal Clear Edge  
Tabs with Neck Loop  
Size: 4" x 1 1/2"  
100 Pack

### PolyTabs®

Perfect for bulk jobs. Perforated every four tabs for easy-to tear-away sheets. Poly tabs are recommended for top strength with lightweight film.

**BAN062**  
Small, Clear,  
No Neck Loop  
Size: 3 1/4" x 1 1/2"  
2000 Count Roll





### PowerTape®

PowerTape® is a single-sided tape made with a super strong film so you get the strength of a hem without the time and hassle of folding a hem.

Thickness: 11 mil



**PTAPEDC**  
White  
Size: 1 1/2" x 36 yd



### Clear PowerTape®

Clear PowerTape® is a single-sided clear hem reinforcing tape. No folding needed. Allows banner graphics to show through. Especially recommended for 2-side printed and mesh banners.

Thickness: 9 mil

**PTAPECLEAR**  
Single-Sided Clear  
Size: 1 1/2" x 36 yd



### MegaTape®

MegaTape® is a double-sided version of Clear PowerTape®. Use with tabs to create the ultimate strength banner.

Thickness: 13 mil

**MEGATAPECL**  
Double-Sided  
Size: 1 1/2" x 30 yd





**TigerTape®**

TigerTape® is double-sided and highly UV, temperature, and plasticizer resistant making it ideal for high-performance banner hemming applications.

Thickness: 6.5 mil



Banner Accessories

Double-sided Banner Tape	
Part No.	Size
<b>TIGTAPE1036</b>	1 " x 36 yd
<b>TIGTAPE1536</b>	1 1/2" x 36 yd
<b>TIGTAPE2036</b>	2" x 36 yd

**Kota Pro™ Double-Sided Banner Hemming Tape**

Get more tape for less money. This tape is the perfect solution for all of your standard banner hemming.

Thickness: 4.5 mil

**KOTA<sub>PRO</sub>**



Double-sided Banner Tape	
Part No.	Size
<b>KPTP100</b>	1 " x 72 yd
<b>KPTP150</b>	1 1/2" x 72 yd
<b>KPTP200</b>	2" x 72 yd





### PoleTape™

PoleTape™ is a double-sided high tack rubber based tape used for creating pole pockets or for splicing banner media together. Recommended for typical outdoor use.\*

Thickness: 35 mil

**POLE135**  
Double-Sided  
Size: 1" x 200 ft



### PoleTape™ Pro

PoleTape™ Pro is a double-sided high tack acrylic tape used for creating pole pockets or for splicing banner media together. Recommended for higher temperature outdoor use.\*

Thickness: 35 mil



**POLEPRO120**  
Double-Sided  
Size: 1" x 36 yd

\*For best results use with 15-18 oz double-sided banner media.

### TexTape®

TexTape® is a double-sided tape designed for high-performance hemming of woven and knitted textiles.

Thickness: 23 mil



**TEX0925**  
Double-Sided Fabric  
Hemming Tape  
Size: 3/8" x 27 yd

**TEX1925**  
Double-Sided Fabric  
Hemming Tape  
Size: 3/4" x 27 yd





# Heat Transfer

*if you're looking for:*

KOTA PRO™ CUT

KOTA PRO™ PRINT & MASK

KOTA PRO™ CLEAR PRINT

STAHL'S PRE-CUT NUMBERS

STAHL'S HEAT TRANSFER MATERIAL

STAHL'S PRINT HEAT TRANSFER MATERIAL

STAHL'S HEAT TRANSFER MASKS

SEF FLEX CUT MAXX

SEF GLITTER FLEX

SEF FLEX CUT SBB

SEF TATTOO SBB

SEF FLEX CUT ATOMIC

SEF FLEX CUT NYLON

SEF FLEX CUT METAL FLEX

SEF FLEX CUT REFLECTIVE

SEF GRAFFITI PRINTABLE MATERIAL

FLEXTAPE

























































# Kota Pro™ Cut Heat Transfer Material

Enjoy the quality, speed and versatility of the Kota Pro™ heat transfer material. The color selection is expansive and the material presses beautifully at a lower temp in **4 SECONDS!** Kota Pro Heat Transfer Material is OEKO-TEX Certified. Enjoy the time and money you'll save with Kota Pro.

**Heat Press Temp:** 285° F/140° C  
**Peel:** Hot  
**Time:** **4 SECONDS**

**Pressure:** Medium  
**Cut Direction:** Mirror  
**Thickness:** 3.1 mil (3.5 mil Neon)

**PRESS TIME  
4 SECONDS!**

 <b>001</b> White	 <b>012</b> Red	 <b>023</b> Midnight	 <b>034</b> Satin Blue	 <b>044</b> Teal
 <b>002</b> Black	 <b>013</b> Wine	 <b>024</b> Bright Purple	 <b>035</b> Baby Blue	 <b>045</b> Ocean
 <b>003</b> Bright Yellow	 <b>014</b> Lilac	 <b>025</b> Satin Purple	 <b>036</b> Lime Green	 <b>046</b> Brown
 <b>004</b> Golden Yellow	 <b>015</b> Light Purple	 <b>026</b> Dark Blue	 <b>037</b> Apple Green	 <b>047</b> Almond
 <b>005</b> Marigold	 <b>016</b> Light Pink	 <b>027</b> Navy	 <b>038</b> Bright Green	 <b>048</b> Tan
 <b>006</b> Orange	 <b>017</b> Pink	 <b>028</b> Bright Blue	 <b>039</b> Green	 <b>049</b> Terracotta
 <b>007</b> Sunset	 <b>018</b> Bubble Gum	 <b>029</b> Royal Blue	 <b>040</b> Forest Green	 <b>050</b> Clay
 <b>008</b> Tangerine	 <b>019</b> Rose	 <b>030</b> Slate Blue	 <b>041</b> Olive Green	 <b>051</b> Bisque
 <b>009</b> Burnt Orange	 <b>020</b> Fuchsia	 <b>031</b> Azure	 <b>042</b> Mint	 <b>052</b> Light Grey
 <b>010</b> Coral Red	 <b>021</b> Grape	 <b>032</b> Electric Blue	 <b>043</b> Turquoise	 <b>053</b> Dark Grey
 <b>011</b> Bright Red	 <b>022</b> Dark Purple	 <b>033</b> Sky Blue		

**KotaPro Opaques, Specials & Neons**

Size
15" x 5 yard
15" x 54 yard

Part # example For 5 yards use KPEX-1502-Color #

**KPEX - 1554 - 001**

Kota Pro Express Series      Width = 15"      Color #

Length = 162' (54 yard)

See page 670 for How to Build a Cut Vinyl Part Number.



 <b>101</b> Rose Gold	 <b>201</b> Neon Yellow
 <b>102</b> Gold	 <b>202</b> Neon Orange
 <b>103</b> Bronze	 <b>203</b> Neon Pink
 <b>104</b> Copper	 <b>204</b> Neon Green
 <b>105</b> Graphite	 <b>205</b> Neon Blue
 <b>106</b> Silver	

## Kota Pro™ Print Heat Transfer Material

Bring your custom apparel designs to life with this line of print heat transfer material from Kota Pro™. You'll fly through production as it prints beautifully and presses in just **4 SECONDS**. The low temperature setting makes this an ideal material for almost any type of fabric. We recommend using Kota Pro Heat Transfer Mask as a transfer tape that also protects the film while pressing. Remove tape while hot.

**Heat Press Temp:** 285° F/140° C  
**Peel:** Hot  
**Time:** **4 SECONDS**

**Pressure:** Medium  
**Print Direction:** Right Reading  
**Thickness:** 3.1 mil



**PRESS TIME  
4 SECONDS!**

Part No.	Size
KPEX-2027-501	20" x 27 yard
KPEX-3027-501	30" x 27 yard
KPEX-6027-501	60" x 27 yard



See pages 216-229 for heat presses

## Kota Pro™ Heat Transfer Mask

This mask is required to transfer Kota Pro™ Heat Transfer Print material from the liner onto the shirt being pressed. Print your design, cut it and then mask it with Kota Pro Heat Transfer Mask. The mask is designed to keep your graphics registered and protected while in the heat press. This is a must-have when working with printable heat transfer material!

Part No.	Size
EXTAPE20A	20" x 27 yard
EXTAPE30A	30" x 27 yard
EXTAPE60A	60" x 27 yard

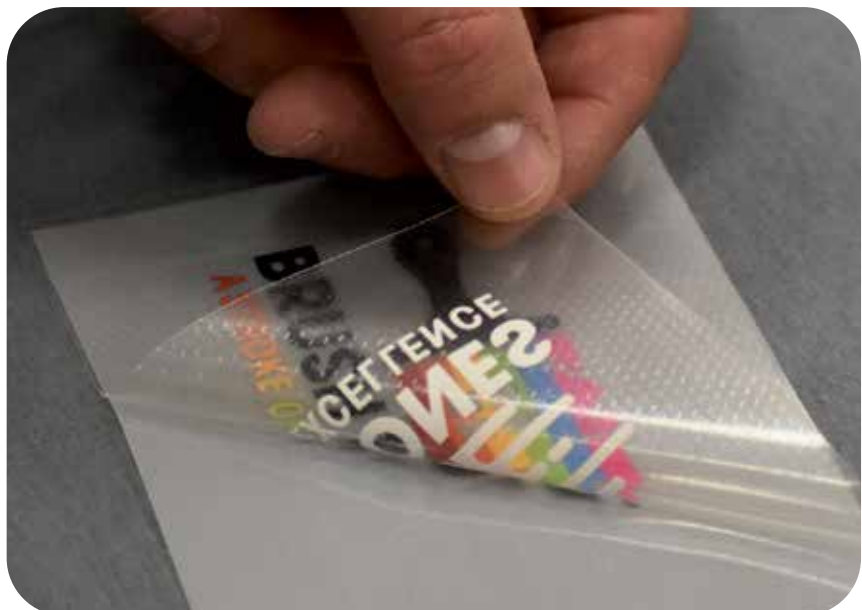

## Kota Pro™ Clear Print Heat Transfer Material

If you're creating designs for light-colored fabrics, you need to try Kota Pro™ Clear Print. It delivers a feel that's similar to screen printing with an eye-catching transparent finish. Print your designs directly onto the adhesive - eliminating the need for transfer tape.

**Heat Press Temp:** 305° F/150° C      **Pressure:** Medium  
**Peel:** Warm      **Print Direction:** Mirror  
**Time:** 10 seconds      **Thickness:** 2.0 mil

**KOTA<sub>PRO</sub>**



Part No.	Size
KPEX-2027-000	20" x 27 yard

Heat Transfer Material



See pages 216-229 for heat presses

## AlbaChem® VLR Vinyl Letter Removing Solvent

Use VLR to completely remove vinyl letters and residues from most fabrics.

- Fast Drying
- Leaves No Stains
- Does Not Contain Any Chlorinated Solvents
- Safe for Most Fabrics

VLR can only be shipped by ground in the continental U.S.

**VLR1020**  
Vinyl Letter Remover  
20 oz.



\* May not remove "overheated" graphics



**NEW PRE-CUT Numbers**



Stahls' Pre-Cut numbers are the most popular choice for personalizing team uniforms. Pre-Cuts feature fast application and low cost, with high quality finishes and durability. Stocking Pre-Cut numbers is perfect for walk-in business and allows you to create last-minute player additions with little to no notice. Stocked in 3 Styles and many sizes.

**Heat Press Temp:** 330° F/165° C  
**Peel:** Hot

**Time:** 6-8 seconds  
**Pressure:** Medium (4 - 6)

**Package Size:**  
1" & 2": 20 Count  
3", 4", 6", 8", 10" & 12": 10 Count

 <b>W</b> White	 <b>RD</b> Red	 <b>NVY</b> Navy
 <b>BK</b> Black	 <b>GD</b> Gold	 <b>RYL</b> Royal

Height Part Number Codes	
Size	
1"	1010
2"	1020
3"	1030
4"	1040
6"	1060
8"	1080
10"	1100
12"	1120

**PRO BLOCK Numbers\* (PB)**  
**1234567890**

Available in Sizes: 1", 2", 3", 4", 6", 8", 10", 12"  
Numbers: 0, 1, 2, 3, 4, 5, 6/9, 7, 8

Pressure Chart	
LIGHT	1 - 3
MEDIUM	4 - 6
FIRM	7 - 9

\*ALL NUMBER ARE CUT FROM THERMO-FILM®

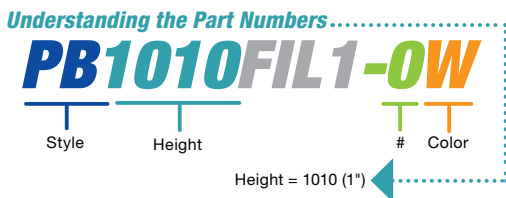

See pages 216-229 for heat presses



**Varsity Numbers\* (VA)**  
**1234567890**

Available in Sizes: 4", 6", 8" & 10"  
Numbers: 0, 1, 2, 3, 4, 5, 6/9, 7, 8

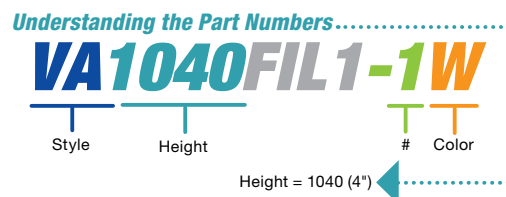

**TEAM US Numbers\* (TU)**  
**1234567890**

Available in 4", 6", 8", 10"  
Numbers: 0, 1, 2, 3, 4, 5, 6/9, 7, 8

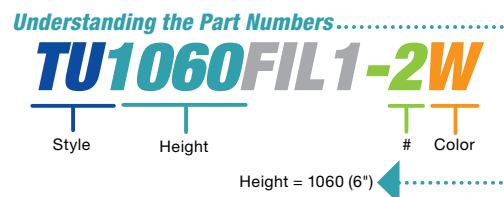

Heat Transfer Material

## NEW CAD-CUT® UltraWeed™



Your go-to material for everyday projects. UltraWeed provides a matte finish and soft feel with effortless weeding and cutting. With a low application temp, it delivers the ultimate, worry-free experience from start to finish.

**Heat Press Temp:** 260°-300° F/126°-149° C    **Time:** 12 seconds  
**Peel:** Hot    **Pressure:** Medium (4 - 6)  
(280-300°F if garment contains 50% or more cotton)

<b>001</b> White	<b>003</b> Red	<b>011</b> Purple	<b>110</b> Lime	<b>048</b> Neon Pink
<b>007</b> Gray	<b>014</b> Cardinal	<b>418</b> Carolina Blue	<b>113</b> Greenery	<b>561</b> Neon Raspberry
<b>002</b> Black	<b>118</b> Dark Crimson	<b>092</b> Light Blue	<b>513</b> Apple Green	<b>132</b> Neon Blue
<b>199</b> Pale Yellow	<b>010</b> Maroon	<b>012</b> Columbia <small>(only in 15")</small>	<b>091</b> Green	<b>049</b> Neon Green
<b>037</b> Maize	<b>185</b> Coral	<b>004</b> Royal	<b>008</b> Kelly	<b>137</b> Metallic Black
<b>090</b> Yellow	<b>017</b> Pink*	<b>055</b> Cyan*	<b>015</b> Dark Green	<b>060</b> Vegas Gold
<b>005</b> Gold	<b>420</b> Medium Pink*	<b>176</b> Light Navy	<b>042</b> Cream*	<b>061</b> Metallic Gold
<b>018</b> Old Gold	<b>319</b> Dark Pink	<b>006</b> Navy	<b>210</b> Medium Brown*	<b>187</b> Rose Gold
<b>041</b> Texas Orange	<b>039</b> Lilac	<b>209</b> Bahama Blue	<b>051</b> Neon Yellow	<b>062</b> Metallic Silver*
<b>009</b> Orange	<b>250</b> Amethyst	<b>111*</b> Mint Blue	<b>050</b> Neon Orange	
<b>134</b> Bright Red	<b>114</b> Ultra Violet	<b>034</b> Shark Teal		

\*Not Available in 20"

### MATERIAL COMPATIBILITY

Cotton • Polyester • Cotton/Poly Blends • Lycra®/Spandex

UltraWeed		
Size	Size	Size
Not available in every color		Not available in every color
12" x 5 yard	15" x 5 yard	20" x 5 yard
12" x 10 yard	15" x 10 yard	20" x 10 yard
12" x 25 yard	15" x 25 yard	20" x 25 yard
12" x 50 yard	15" x 50 yard	20" x 50 yard

CUTTING INSTRUCTIONS				
Cutter	Blade	Force	Offset	Speed
Graphtec	45°	7-9	0	20 cm/s

### Understanding the Part Numbers.....

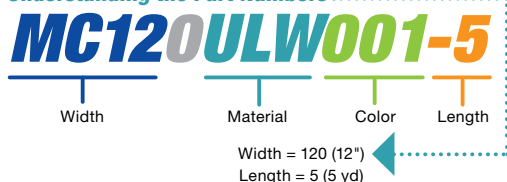

See pages 216-229 for heat presses



**NEW** CAD-CUT® Thermo-FILM® & Thermo-GRIP®



The #1 choice for contact sports uniforms, Thermo-FILM® and Thermo-GRIP® have a semi-gloss finish with the strength to stick and stay on. Thermo-FILM® offers extreme durability and enhanced abrasion resistance. Its superior opacity is perfect for inhibiting dye migration. Thermo-GRIP®, the best choice for nylon athletic garments, has a patented adhesive specially formulated to decorate Dazzle and nylon mesh with ease.

**Heat Press Temp:** 330° F/165° C  
**Time:** 6-8 seconds  
**Peel:** Thermo-FILM: Hot  
 Thermo-GRIP: Warm  
**Pressure:** Medium (4 - 6)

<b>001</b> White*	<b>018</b> Old Gold	<b>010</b> Maroon*	<b>012</b> Columbia	<b>008</b> Kelly
<b>002</b> Black*	<b>009</b> Orange*	<b>017</b> Pink	<b>004</b> Royal*	<b>015</b> Dark Green*
<b>007</b> Gray*	<b>003</b> Red*	<b>011</b> Purple*	<b>006</b> Navy*	<b>060</b> Vegas Gold
<b>037</b> Maize	<b>014</b> Cardinal	<b>068</b> Brown	<b>034</b> Shark Teal	<b>062</b> Metallic Silver
<b>005</b> Gold*	*Available in Thermo-GRIP			

See pages 216-229 for heat presses

**MATERIAL COMPATIBILITY**  
**THERMO-FILM**

Cotton • Polyester • Cotton/Poly Blends

**THERMO-GRIP**

Cotton • Polyester • Cotton/Poly Blends • Nylon Mesh

Thermo-FILM & Thermo-GRIP	
Size	Size
15" x 5 yard	20" x 5 yard
15" x 10 yard	20" x 10 yard
15" x 25 yard	20" x 25 yard
15" x 50 yard	20" x 50 yard

Pressure Chart	
<b>LIGHT</b>	1 - 3
<b>MEDIUM</b>	4 - 6
<b>FIRM</b>	7 - 9

**CUTTING INSTRUCTIONS**

Cutter	Blade	Force	Offset	Speed
Graphtec	45°	18-20	0	30 cm/s

Understanding the Part Numbers.....

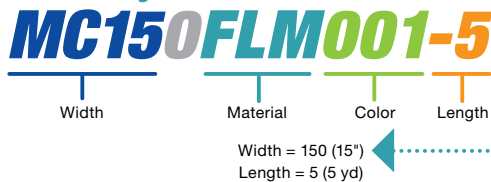

Understanding the Part Numbers.....

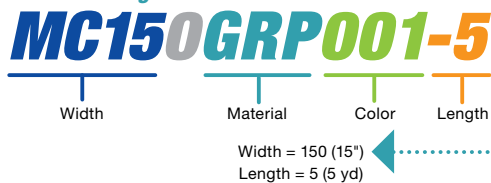

Heat Transfer Material



**NEW CAD-CUT® Premium Plus™**



Perfect for personalization on performance wear. With its soft, lightweight feel, high stretch and rebound properties, Premium Plus™ is one of the most versatile heat transfer materials available. This low-temp material with a soft, silky matte finish is the ideal choice when decorating heat-sensitive performance wear.

**Heat Press Temp:** 280°-300° F/138°-148° C  
**Peel:** Hot  
**Time:** 8-12 seconds  
**Pressure:** Medium (4 - 6)

<b>001</b> White	<b>041</b> Texas Orange	<b>418</b> Carolina Blue	<b>513</b> Apple Green	<b>050</b> Neon Orange
<b>007</b> Gray	<b>003</b> Red	<b>012</b> Columbia	<b>008</b> Kelly	<b>048</b> Neon Pink
<b>329</b> Charcoal	<b>505</b> Burgundy	<b>055</b> Cyan	<b>015</b> Dark Green	<b>132</b> Neon Blue
<b>002</b> Black	<b>010</b> Maroon	<b>004</b> Royal	<b>411</b> Camel	<b>049</b> Neon Green
<b>037</b> Maize	<b>017</b> Pink	<b>427</b> University Blue	<b>210</b> Medium Brown	<b>062</b> Metallic Silver
<b>005</b> Gold	<b>420</b> Medium Pink	<b>006</b> Navy	<b>068</b> Brown	<b>061</b> Metallic Gold
<b>018</b> Old Gold	<b>043</b> Fuchisa	<b>209</b> Bahama Blue	<b>051</b> Neon Yellow	
<b>009</b> Orange	<b>011</b> Purple	<b>013</b> Teal		

**MATERIAL COMPATIBILITY**

Cotton • Polyester • Cotton/Poly Blends  
 Lycra®/Spandex

Premium Plus Size
20" x 5 yard
20" x 10 yard
20" x 25 yard
20" x 50 yard

See pages 216-229  
 for heat presses

CUTTING INSTRUCTIONS				
Cutter	Blade	Force	Offset	Speed
Graphtec	45°	9-11	0	20 cm/s

Understanding the Part Numbers...

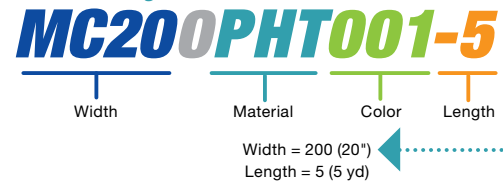

Heat Transfer Material



**NEW** CAD-CUT® SportFilm Lite™



Best value material for lightweight garments. With a semi-matte finish, SportFilm Lite™ is thin, flexible and durable. It cuts and weeds easily. Not recommended for layered 2-color applications.

**Heat Press Temp:** 302° F/150° C  
**Peel:** Warm  
**Time:** 10-12 seconds  
**Pressure:** Medium (4 - 6)

<b>001</b> White	<b>009</b> Orange	<b>012</b> Columbia	<b>015</b> Dark Green	<b>132</b> Neon Blue
<b>007</b> Gray	<b>003</b> Red	<b>004</b> Royal	<b>068</b> Brown	<b>049</b> Neon Green
<b>002</b> Black	<b>010</b> Maroon	<b>006</b> Navy	<b>051</b> Neon Yellow	<b>062</b> Metallic Silver
<b>037</b> Maize	<b>011</b> Purple	<b>034</b> Shark Teal	<b>050</b> Neon Orange	<b>060</b> Vegas Gold
<b>180</b> Athletic Gold	<b>506</b> Sky Blue	<b>008</b> Kelly	<b>048</b> Neon Pink	<b>061</b> Metallic Gold

**MATERIAL COMPATIBILITY**

Cotton • Polyester • Cotton/Poly Blends  
 Lycra®/Spandex • Nylon

Sportsfilm Lite
Size
20" x 5 yard
20" x 10 yard
20" x 25 yard
20" x 50 yard

CUTTING INSTRUCTIONS				
Cutter	Blade	Force	Offset	Speed
Graphtec	45°	9-11	0	30 cm/s

See pages 216-229  
 for heat presses

Understanding the Part Numbers

**MC200SFL007-5**

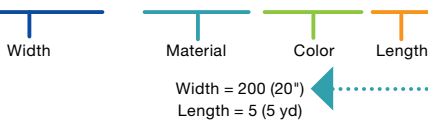

Pressure Chart	
<b>LIGHT</b>	1 - 3
<b>MEDIUM</b>	4 - 6
<b>FIRM</b>	7 - 9



Heat Transfer Material

**NEW CAD-CUT® Silicone Dye-Block™**

Eliminate dye migration – even on sublimated polyester sports jerseys. Trust the industry’s first cuttable solution to fully block dye migration. With application temps as low as 290°F, this material has a matte finish and rubber-like feel. Finished apparel is stretchable with good recovery.

**Heat Press Temp:** 290°-302° F/143°-150° C     **Time:** 10-15 seconds  
**Peel:** Cold     **Pressure:** Medium (4 - 6)



**MATERIAL COMPATIBILITY**

Sublimated Polyester • Cotton • Polyester  
 Cotton/Poly Blends • Uncoated Nylon

Silicone Dye-Block	
Size	
20" x 5 yard	
20" x 10 yard	
20" x 25 yard	
20" x 50 yard	

CUTTING INSTRUCTIONS				
Cutter	Blade	Force	Offset	Speed
Graphtec	45°	11-13	0	20 cm/s

*See pages 216-229  
for heat presses*

**Understanding the Part Numbers.....**

**MC200SI2001-5**

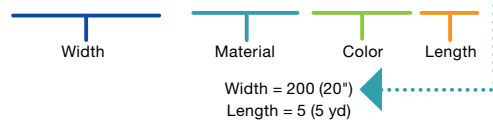

Pressure Chart	
LIGHT	1 - 3
MEDIUM	4 - 6
FIRM	7 - 9

Heat Transfer Material





**NEW CAD-CUT® GORILLA GRIP® II**



Best choice for heat printing on nylon. Ideal for decorating equipment bags and jackets, GORILLA GRIP® vinyl adheres to difficult fabrics such as tightly woven nylons, oxfords, satin, crinkle, and rip stop nylon. Its finish is a soft matte.

**Heat Press Temp:** 320° F/160° C  
**Peel:** Cold  
**Pressure:** Light (1 - 3)  
**Time:** Tack 2 seconds, peel cold, cover & seal 10 seconds

<b>001</b> White	<b>003</b> Red	<b>004</b> Royal	<b>008</b> Kelly	<b>062</b> Metallic Silver
<b>002</b> Black	<b>059</b> Hot Pink	<b>006</b> Navy	<b>060</b> Vegas Gold	<b>061</b> Metallic Gold
<b>005</b> Gold				

**MATERIAL COMPATIBILITY**  
 Cotton • Cordura® • Nylon

Gorilla Grip II Size
19" x 5 yard
19" x 10 yard
19" x 25 yard
19" x 50 yard

CUTTING INSTRUCTIONS				
Cutter	Blade	Force	Offset	Speed
Graphtec	45°	8-10	0	20 cm/s

See pages 216-229 for heat presses

**Understanding the Part Numbers.....**

**MC190GGP001-5**

Width | Material | Color | Length

Width = 190 (19")  
 Length = 5 (5 yd)

Pressure Chart	
LIGHT	1 - 3
MEDIUM	4 - 6
FIRM	7 - 9

















Heat Transfer Material

**NEW CAD-CUT® Soft Foam**

Upgrade apparel with this specialty dimensional material. Soft and pliable when heat is applied, CAD-CUT® Soft Foam offers all the benefits of traditional HTV with a unique, raised look and feel. Its ultra-matte finish, velvet-like texture and dimensional effect is perfect for creating premium designs for everyday fashion, spirit wear, athletics, and more.

**Heat Press Temp:** 300° F/150° C  
**Peel:** Cold

**Time:** 15 seconds  
**Pressure:** Light/Medium (3 - 4)

 <b>001</b> White	 <b>074</b> Raven Gold	 <b>006</b> Navy	 <b>431</b> Textured Black	 <b>436</b> Textured Mint
 <b>054</b> Eagle Gray	 <b>134</b> Bright Red	 <b>417</b> Camel	 <b>432</b> Textured Pink	 <b>433</b> Textured Dark Tan
 <b>002</b> Black	 <b>004</b> Royal	 <b>430</b> Textured White	 <b>435</b> Textured light Blue	 <b>434</b> Textured Brown

**MATERIAL COMPATIBILITY**

Cotton • Polyester • Cotton/Poly Blends

Soft Foam
Size
20" x 5 yard
20" x 10 yard
20" x 25 yard

Pressure Chart	
<b>LIGHT</b>	1 - 3
<b>MEDIUM</b>	4 - 6
<b>FIRM</b>	7 - 9

CUTTING INSTRUCTIONS				
Cutter	Blade	Force	Offset	Speed
Graphtec	45°	24-26	0	30 cm/s

*Understanding the Part Numbers.....*

**MC200SFM001-5**

Width | Material | Color | Length

Width = 200 (20")  
Length = 5 (5 yd)

See pages 216-229 for heat presses



Heat Transfer Material

**NEW CAD-CUT® Soft Flock**



Create textured designs with this vibrant, suede-like material. CAD-CUT® Soft Flock is a budget-friendly alternative to embroidery for left chest logos and more. Delivering a matte finish, it's made with high-density, high-quality fibers that produce vibrant and long-lasting colors.

**Heat Press Temp:** 311° F/155° C  
**Peel:** Warm  
**Time:** 15 seconds  
**Pressure:** Medium (4 - 6)

	<b>001</b> White		<b>294</b> Boot Yellow		<b>218</b> Pale Pink		<b>004</b> Royal		<b>091</b> Green
	<b>007</b> Gray		<b>005</b> Gold		<b>043</b> Fuchsia		<b>006</b> Navy		<b>532</b> Olive
	<b>329</b> Charcoal		<b>009</b> Orange		<b>505</b> Burgundy		<b>045</b> Turquoise		<b>068</b> Brown
	<b>002</b> Black		<b>134</b> Bright Red		<b>011</b> Purple		<b>296</b> Sea Glass		<b>295</b> Baby's Breath
	<b>085</b> Lemon Yellow		<b>219</b> Deep Red		<b>555</b> Pale Blue				

**MATERIAL COMPATIBILITY**  
 Cotton • Polyester • Cotton/Poly Blends

Soft Flock	
Size	Size
12" x 5 yard	15" x 5 yard
12" x 10 yard	15" x 10 yard
12" x 25 yard	15" x 25 yard
12" x 50 yard	15" x 50 yard

CUTTING INSTRUCTIONS				
Cutter	Blade	Force	Offset	Speed
Graphtec	45°	12	0	25 cm/s

Understanding the Part Numbers...



See pages 216-229 for heat presses



Heat Transfer Material



**NEW CAD-CUT® Fashion-FILM® Electric**



Offer a vivid color palette for fashionable looks with this thin, soft and durable material. Trust this bold and unique special effect material to add high-energy, fine-detail designs to apparel. Fashion-FILM® Electric colors have a bright jewel-like satin and metallic finish and are perfect for creating vivid looks your customers will love.

**Heat Press Temp:** 320° F/160° C  
**Peel:** Hot  
**Time:** 15 seconds  
**Pressure:** Medium (4 - 6)



**MATERIAL COMPATIBILITY**  
 Cotton • Polyester • Cotton/Poly Blends  
 Lycra®/Spandex

Fashion-FILM Electric	
Size	Size
12" x 5 yard	15" x 5 yard
12" x 10 yard	15" x 10 yard
12" x 25 yard	15" x 25 yard
12" x 50 yard	15" x 50 yard

CUTTING INSTRUCTIONS				
Cutter	Blade	Force	Offset	Speed
Graphtec	45°	8-10	0	30 cm/s

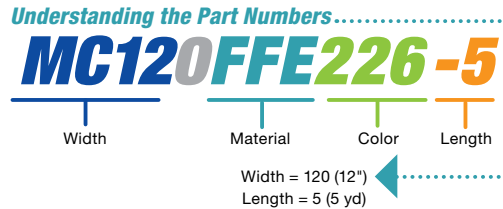

See pages 216-229  
 for heat presses

Pressure Chart	
LIGHT	1 - 3
MEDIUM	4 - 6
FIRM	7 - 9



Heat Transfer Material

**NEW CAD-CUT® Glitter Flake™**



Ideal for cheer and spirit wear, Stahl's most popular special effect material will create looks that sparkle and shine! Highly durable with a textured finish, Glitter Flake stands out on the playground, on the sidelines, on campus, or anywhere else you'll find fan wear, cheer apparel, and fashion garments.

**Heat Press Temp:** 290°-302° F/143°-150° C  
**Peel:** Hot  
**Time:** 10-12 seconds  
**Pressure:** Medium (4 - 6)

<b>001</b> White	<b>185</b> Coral	<b>011</b> Purple	<b>331</b> Light Green	<b>122</b> Light Multi
<b>182</b> Rainbow White	<b>225</b> Rainbow Coral	<b>035</b> Eggplant	<b>008</b> Kelly	<b>126</b> Black/Silver
<b>329</b> Charcoal	<b>003</b> Red	<b>183</b> Periwinkle	<b>015</b> Dark Green	<b>124</b> Black/Gold
<b>002</b> Black	<b>010</b> Maroon	<b>012</b> Columbia	<b>098</b> Fluorescent Yellow	<b>223</b> Vintage Gold
<b>186</b> Rainbow Black	<b>321</b> Light Pink	<b>004</b> Royal	<b>100</b> Fluorescent Orange	<b>005</b> Gold
<b>199</b> Pale Yellow	<b>420</b> Medium Pink	<b>178</b> Bright Royal	<b>101</b> Fluorescent Pink	<b>201</b> Hologram Gold
<b>121</b> Yellow Gold	<b>017</b> Pink	<b>006</b> Navy	<b>104</b> Fluorescent Purple	<b>125</b> Confetti
<b>009</b> Orange	<b>127</b> Cherry	<b>123</b> Aqua	<b>103</b> Fluorescent Blue	<b>212</b> Florida Orange
<b>187</b> Rose Gold	<b>059</b> Hot Pink	<b>198</b> Beach Blue	<b>099</b> Fluorescent Green	<b>214</b> Teakwood
<b>196</b> Copper	<b>224</b> Rainbow Plum	<b>184</b> Mint	<b>064</b> Silver	<b>306</b> Peacock Teal
<b>069</b> Bronze	<b>149</b> Plum	<b>084</b> Jade	<b>200</b> Hologram Silver	<b>213</b> Coronado Gold
<b>068</b> Brown	<b>307</b> Lavender	<b>091</b> Green		

See pages 216-229 for heat presses

**MATERIAL COMPATIBILITY**

Cotton • Polyester • Cotton/Poly Blends

Glitter Flake	
Size	Size
12" x 5 yard	20" x 5 yard
12" x 10 yard	20" x 10 yard
12" x 25 yard	20" x 25 yard
12" x 50 yard	20" x 50 yard

**Understanding the Part Numbers.....**

**MC120GFL001-5**

Width: 120 (12")  
 Material: G  
 Color: F  
 Length: 001-5 (5 yd)

CUTTING INSTRUCTIONS				
Cutter	Blade	Force	Offset	Speed
Graphtec	45°	18-22	0	30 cm/s



Heat Transfer Material



**NEW CAD-CUT® Hologram**



Bright lights and big impact - Hologram heat transfer vinyl has a shiny, high-gloss prism-like finish which creates a rainbow effect that shifts as the garment moves. Create a distinct and unique look with this prism-like material.

**Heat Press Temp:** 320° F/160° C  
**Peel:** Cold

**Time:** 10-15 seconds  
**Pressure:** Firm (7 - 9)

<b>002</b> Black	<b>043</b> Fuchsia	<b>022</b> Blue	<b>091</b> Green	<b>241</b> Multi Rainbow
<b>009</b> Orange	<b>011</b> Purple	<b>006</b> Navy	<b>064</b> Silver	<b>256</b> Crystal
<b>003</b> Red	<b>092</b> Light Blue	<b>123</b> Aqua	<b>005</b> Gold	<b>242</b> Gold Crystal
<b>017</b> Pink				

See pages 216-229  
for heat presses

CUTTING INSTRUCTIONS				
Cutter	Blade	Force	Offset	Speed
Graphtec	45°	15-17	0	30 cm/s

**MATERIAL COMPATIBILITY**  
Cotton • Polyester • Cotton/Poly Blends

Hologram
Size
20" x 5 yard
20" x 25 yard

Pressure Chart	
<b>LIGHT</b>	1 - 3
<b>MEDIUM</b>	4 - 6
<b>FIRM</b>	7 - 9

Understanding the Part Numbers.....

**MC200HOL002-5**

Width | Material | Color | Length

Width = 200 (20")  
Length = 5 (5 yd)

Heat Transfer Material





**NEW CAD-CUT® UV Shift**



Color changing HTV that transforms in sunlight! Give custom apparel a creative edge with this magical, color changing material that appears white until activated by sun or UV light. With a matte finish and a soft hand, UV Shift is ideal for T-shirts, hoodies, fashion and children's apparel.

**Heat Press Temp:** 302° F/150° C  
**Peel:** Hot

**Time:** 10-12 seconds  
**Pressure:** Medium (4 - 6)



**090**  
Yellow

**207**  
Magenta



**022**  
Blue

**096**  
Violet



**MATERIAL COMPATIBILITY**  
 Cotton • Polyester • Cotton/Poly Blends

UV Shift
Size
12" x 5 yard
12" x 10 yard
12" x 25 yard
12" x 50 yard

See pages 216-229  
 for heat presses

Pressure Chart	
<b>LIGHT</b>	1 - 3
<b>MEDIUM</b>	4 - 6
<b>FIRM</b>	7 - 9

CUTTING INSTRUCTIONS				
Cutter	Blade	Force	Offset	Speed
Graphtec	45°	8	0	30 cm/s

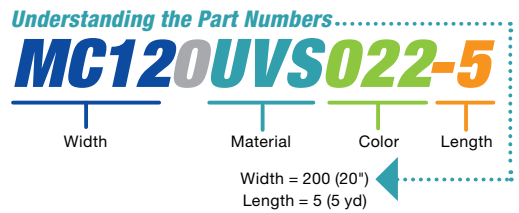

Heat Transfer Material

**NEW CAD-CUT® Chroma Bling**

Unique iridescent vinyl for eye-catching designs that change color based on lighting and garment. Chroma Bling combines a shiny, high-gloss metallic finish with an iridescent shimmer to create a truly unique visual effect. Blue Shift and Clear Shift are semi-transparent and will change depending on the color of the background fabric.

**Heat Press Temp:** 300° F/150° C  
**Peel:** Cold

**Time:** 10 seconds  
**Pressure:** Medium (4 - 6)

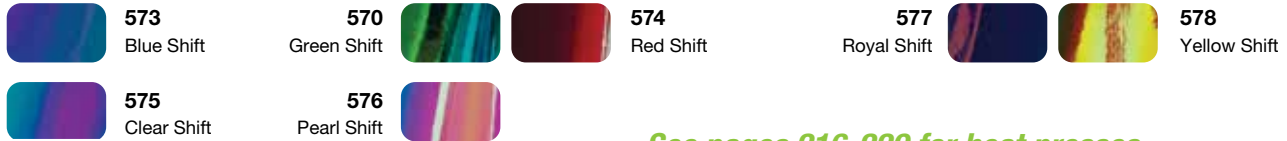

See pages 216-229 for heat presses

**MATERIAL COMPATIBILITY**

Cotton • Polyester • Cotton/Poly Blends

Chroma Bling (excludes Blue Shift)	Chroma Bling Blue Shift ONLY
Size	Size
12" x 5 yard	20" x 5 yard
12" x 10 yard	20" x 10 yard
12" x 25 yard	20" x 25 yard
12" x 50 yard	20" x 50 yard

CUTTING INSTRUCTIONS				
Cutter	Blade	Force	Offset	Speed
Graphtec	45°	10-16	0	30 cm/s

Understanding the Part Numbers...



Understanding the Part Numbers...

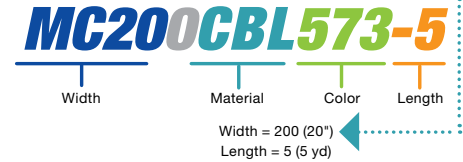

Heat Transfer Material



**NEW CAD-CUT® Chalkboard**



The power of instant personalization. Turn any shirt into a chalkboard with this innovative heat transfer vinyl. Using standard chalk, customers can write or draw anything they want on the unique surface, then wipe it clean with a damp cloth. Thin, with a soft hand, Chalkboard applies at a low temperature – making it great for heat-sensitive fabrics.

**Heat Press Temp:** 275°F/135° C  
**Peel:** Warm

**Time:** 15 seconds  
**Pressure:** Medium (4 - 6)



**002**  
Black

CUTTING INSTRUCTIONS				
Cutter	Blade	Force	Offset	Speed
Graphtec	45°	8-10	0	30 cm/s

**MATERIAL COMPATIBILITY**

Cotton • Polyester • Cotton/Poly Blends

Chalkboard	
Part No.	Size
MC120CHB002-5	12" x 5 yard
MC120CHB002-10	12" x 10 yard
MC120CHB002-25	12" x 25 yard
MC120CHB002-50	12" x 50 yard

See pages 216-229  
for heat presses

Pressure Chart	
LIGHT	1 - 3
MEDIUM	4 - 6
FIRM	7 - 9



Heat Transfer Material

**NEW CAD-CUT® Glow**

Create glow-in-the-dark graphics to personalize Halloween costumes, spirit wear, promotional T-shirts and other apparel, bags and accessories. Thin, soft and extremely durable, Glow has a matte finish. The material appears white in normal lighting and emits a lime-colored glow when the lights are out.

**Heat Press Temp:** 305°F/152° C  
**Peel:** Warm

**Time:** 10-15 seconds  
**Pressure:** Medium (4 - 6)



**135**  
White/Lime

CUTTING INSTRUCTIONS				
Cutter	Blade	Force	Offset	Speed
Graphtec	45°	8-10	0	30 cm/s

**MATERIAL COMPATIBILITY**  
 Cotton • Polyester • Cotton/Poly Blends

Glow	
Part No.	Size
MC200GLW135-5	20" x 5 yard
MC200GLW135-25	20" x 25 yard

See pages 216-229  
for heat presses





**NEW CAD-CUT® Reflective Glitter**

Offer your customers creative designs that dazzle and shine bright. This smooth glitter HTV that won't flake off features a glossy feel and unique reflective finish that shifts in the light. Only recommended for single layer applications.

**Heat Press Temp:** 300° F/149° C  
**Peel:** Warm

**Time:** 15 seconds  
**Pressure:** Medium (4 - 6)

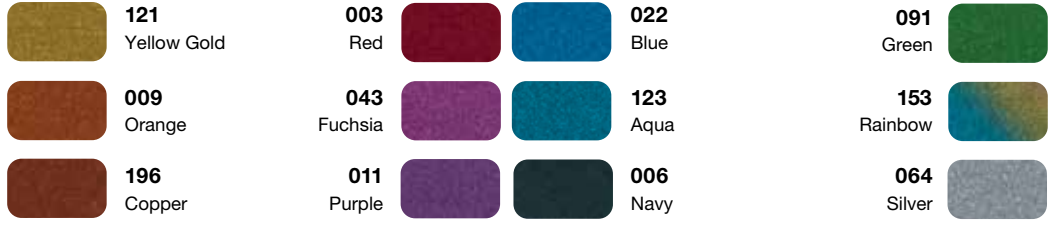

**MATERIAL COMPATIBILITY**

Cotton • Polyester • Cotton/Poly Blends

Reflective Glitter
Size
20" x 5 yard
20" x 10 yard
20" x 25 yard
20" x 50 yard

See pages 216-229  
for heat presses

CUTTING INSTRUCTIONS				
Cutter	Blade	Force	Offset	Speed
Graphtec	45°	13	0	35 cm/s

Understanding the Part Numbers.....

**MC200RGL003-5**

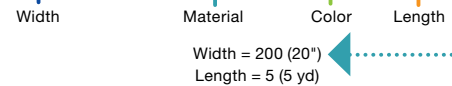

Heat Transfer Material



**NEW CAD-CUT® Metallic**



The foil-like finish and soft feel of Metallic HTV lets you personalize apparel with a higher-perceived value. With a low temp 1-step application, Metallic is easy to cut and weed, thin and stretchable with the ability to hold fine detail.

**Heat Press Temp:** 285° F/140° C  
**Peel:** Cold

**Time:** 8-10 seconds  
**Pressure:** Medium (4 - 6)

<b>069</b> Bronze	<b>003</b> Red	<b>059</b> Hot Pink	<b>092</b> Light Blue	<b>064</b> Silver
<b>068</b> Brown	<b>261</b> Rose	<b>011</b> Purple	<b>004</b> Royal	<b>005</b> Gold

**MATERIAL COMPATIBILITY**

Cotton • Polyester • Cotton/Poly Blends

Metallic
Size
20" x 5 yard
20" x 10 yard
20" x 25 yard
20" x 50 yard

CUTTING INSTRUCTIONS				
Cutter	Blade	Force	Offset	Speed
Graphtec	45°	8-10	0	30 cm/s

*Understanding the Part Numbers.....*

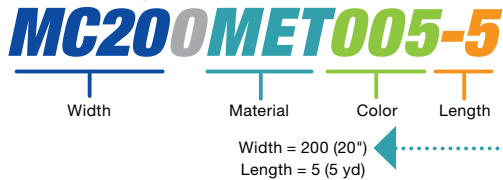

See pages 216-229 for heat presses

Pressure Chart	
<b>LIGHT</b>	1 - 3
<b>MEDIUM</b>	4 - 6
<b>FIRM</b>	7 - 9



Heat Transfer Material

**NEW CAD-CUT® Heat Transfer Foil**

Perfect for fashion-forward decoration, creating attention-grabbing designs and two-tone looks. With vibrant colors available, Heat Transfer Foil is the easy, no-mess alternative to screen printing metallic finishes on garments when used with CAD-CUT® Heat Press Adhesive. Create matte, distressed or multi-colored looks.

**Heat Press Temp:** 300° F/149° C  
**Peel:** Cold

**Time:** 8-10 seconds  
**Pressure:** Firm (7 - 9)

 <b>CK2</b> Black	 <b>CR4</b> Red	 <b>CV2</b> Amethyst	 <b>CN1</b> Green	 <b>CSOK114</b> Silver Waterfall
 <b>CHC</b> Bright Gold*	 <b>CRA</b> Burgundy	 <b>CBH</b> Sapphire Blue	 <b>CS5</b> Bright Silver*	 <b>CSEKP92</b> Scales
 <b>CH4</b> Yellow Gold*	 <b>CHJ</b> Rose Gold	 <b>CBD</b> Navy	 <b>CSOKP24</b> Silver Champagne	 <b>CSOZP02</b> Halo Rainbow Silver
 <b>CHA</b> Copper	 <b>CPC</b> Light Rose	 <b>CBA</b> Teal	 <b>CSOHP38</b> Silver Cracked Ice	 <b>CMCAA01</b> Classic Rainbow
 <b>CEB</b> Orange	 <b>CP1</b> Pink	 <b>CNE</b> Kiwi	 <b>CSOKP12</b> Silver Pixie Dust	 <b>CH3AK01</b> Leopard
 <b>CPF</b> Coral	*Available in 12" x 200'			

**MATERIAL COMPATIBILITY**

Cotton • Polyester • Cotton/Poly Blends

Heat Transfer Foil	
Size	
12" x 25 feet	
12" x 200 feet	

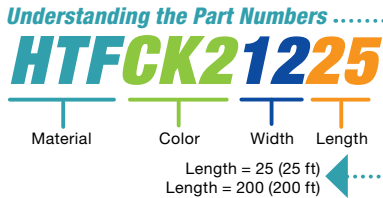

Heat Transfer Material

**NEW CAD-CUT® Heat Press Adhesive**

Trust for long-lasting foil embellishments. Heat transfer foils are known for being short-term embellishments when added to transfer papers and plastisol inks. This foil adhesive solves that problem by permanently binding the foil. May be cut in a laser.

**Heat Press Temp:** 300° F/149° C  
**Peel:** Hot

**Time:** 3-5 seconds  
**Pressure:** Light (2 - 3)

**MATERIAL COMPATIBILITY**

Cotton • Polyester • Cotton/Poly Blends

CUTTING INSTRUCTIONS				
Cutter	Blade	Force	Offset	Speed
Graphtec	45°	7-9	0	20 cm/s

Heat Press Adhesive	
Part No.	Size
MC118CCH000-5	11.8" x 5 yard
MC118CCH000-10	11.8" x 10 yard
MC118CCH000-25	11.8" x 25 yard
MC118CCH000-50	11.8" x 50 yard

Heat Press Adhesive	
Part No.	Size
MC200CCH000-5	20" x 5 yard
MC200CCH000-10	20" x 10 yard
MC200CCH000-25	20" x 25 yard
MC200CCH000-50	20" x 50 yard





**NEW CAD-CUT® Puff**



Elevate your apparel with the perfect material to create popular cloud-like designs. With Puff, you can easily create a trendy dimensional look with just one layer of HTV. The material starts flat for easy cutting and puffs up after heat application. Available in a variety of colors with a textured matte finish, Puff is best for simple or larger designs.

**Heat Press Temp:** 280° F/138° C  
**Peel:** Hot  
**Time:** 8-10 seconds  
**Pressure:** Medium/Firm (6 - 7)

<b>001</b> White	<b>509</b> Beige	<b>420</b> Medium Pink	<b>513</b> Apple Green	<b>050</b> Neon Orange
<b>002</b> Black	<b>520</b> Chocolate Brown	<b>011</b> Purple	<b>091</b> Green	<b>132</b> Neon Blue
<b>005</b> Gold	<b>003</b> Red	<b>092</b> Light Blue	<b>051</b> Neon Yellow	
<b>009</b> Orange	<b>321</b> Light Pink	<b>006</b> Navy		

**MATERIAL COMPATIBILITY**

Cotton • Polyester • Cotton/Poly Blends

Puff Size
12" x 5 yard
12" x 10 yard
12" x 25 yard

See pages 216-229 for heat presses

Pressure Chart	
<b>LIGHT</b>	1 - 3
<b>MEDIUM</b>	4 - 6
<b>FIRM</b>	7 - 9

CUTTING INSTRUCTIONS				
Cutter	Blade	Force	Offset	Speed
Graphtec	45°	8-9	0	30 cm/s

Understanding the Part Numbers.....

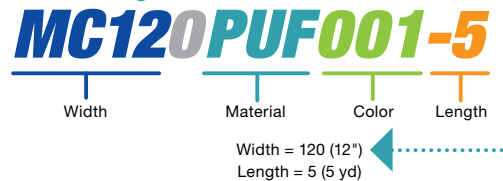

Heat Transfer Material

**NEW CAD-CUT® Chroma-Twill™**



Create shimmering, colorful twill designs without embroidery equipment! This glossy heat transfer material features an iridescent finish with the look and feel of a traditional fabric twill. Chroma-Twill™ can be layered on top of itself.

**Heat Press Temp:** 302° F/150° C  
**Peel:** Cold

**Time:** 20 seconds  
**Pressure:** Medium (4 - 6)

	<b>001</b> White		<b>081</b> Nugget Gold		<b>506</b> Sky Blue		<b>193</b> Artic Green		<b>048</b> Neon Pink
	<b>064</b> Silver		<b>116</b> Poppy Red		<b>094</b> Lime Green		<b>051</b> Neon Yellow		<b>049</b> Neon Green
	<b>090</b> Yellow		<b>017</b> Pink		<b>084</b> Jade		<b>050</b> Neon Orange		

**MATERIAL COMPATIBILITY**

Cotton • Polyester • Cotton/Poly Blends

Chroma-Twill	
Size	Size
12" x 5 yard	20" x 5 yard
12" x 10 yard	20" x 10 yard
12" x 25 yard	20" x 25 yard
12" x 50 yard	20" x 50 yard

See pages 216-235  
for heat presses

Pressure Chart	
<b>LIGHT</b>	1 - 3
<b>MEDIUM</b>	4 - 6
<b>FIRM</b>	7 - 9

CUTTING INSTRUCTIONS				
Cutter	Blade	Force	Offset	Speed
Graphtec	45°	12	0	20 cm/s

Understanding the Part Numbers.....

**MC120CHT001-5**

Width | Material | Color | Length

Width = 120 (12")  
Length = 5 (5 yd)

Heat Transfer Material



**NEW CAD-CUT® 3M™ Scotchlite™ 5807**



Perfect for safety wear, this waterproof material brightly reflects vehicle headlights, making it perfect for high-visibility apparel used by emergency workers, joggers, bikers, and anyone else who needs to be seen at night. It meets performance standards such as ANSI/ISEA 107, CSA Z96, and EN 471.

**Heat Press Temp:** 325°-350° F/165°-177° C      **Time:** 10-20 seconds  
**Peel:** Hot      **Pressure:** Firm (7 - 9)



**064**  
Silver

**MATERIAL COMPATIBILITY**

Cotton • Polyester • Cotton/Poly Blends  
 Nylon • Cordura® • Lycra®/Spandex

3M Scotchlite 5870	
Size	Size
16" x 5 yard	24" x 5 yard
16" x 10 yard	24" x 10 yard
16" x 25 yard	24" x 25 yard
16" x 50 yard	24" x 50 yard



*Understanding the Part Numbers...*

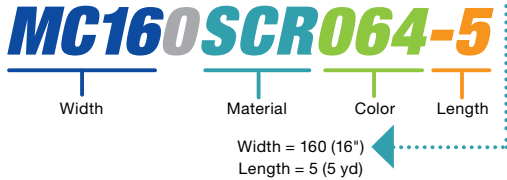

CUTTING INSTRUCTIONS				
Cutter	Blade	Force	Offset	Speed
Graphtec	45°	12-14	0	30 cm/s

See pages 216-229 for heat presses

Pressure Chart	
LIGHT	1 - 3
MEDIUM	4 - 6
FIRM	7 - 9

**NEW CAD-CUT® Reflective II**

Add high-visibility reflective graphics that get noticed. Excellent for use as an accent on sports uniforms and accessories. Use for added visibility on backpacks, jackets, fashion apparel, and more. PVC-free with a lower application temp, Reflective II works well on synthetic materials.

**Heat Press Temp:** 290° F/143° C      **Time:** 10-12 seconds  
**Peel:** Hot      **Pressure:** Medium (4 - 6)



**000**  
Silver

**MATERIAL COMPATIBILITY**  
 Cotton • Polyester  
 Cotton/Poly Blends • Nylon



Reflective II	
Part No.	Size
MC200RII-5	20" x 5 yard
MC200RII-10	20" x 10 yard
MC200RII-25	20" x 25 yard
MC200RII-50	20" x 50 yard

CUTTING INSTRUCTIONS				
Cutter	Blade	Force	Offset	Speed
Graphtec	45°	11-13	0	30 cm/s

See pages 216-229 for heat presses

Heat Transfer Material



**NEW CAD-COLOR® Express Print®**

Stahls' most popular and cost-effective printable media. Durable and lightweight with a semi-matte finish, Express Print is perfect for creating full color transfers with solvent or eco-solvent based printers. It's a production favorite with a fast dry time, easy weeding, and quick masking. Note – not compatible with laser cutters or inkjet/laser printers.

**Heat Press Temp:** 300° F/149° C  
**Peel:** Warm

**Time:** 15-20 seconds  
**Pressure:** Medium (4 - 6)

**Polypropylene Only**  
**Heat Press Temp:** 250° F/121° C  
**Peel:** Hot

**Time:** 15 seconds  
**Pressure:** Medium (4 - 6)

**MATERIAL COMPATIBILITY**

Cotton • Polyester • Cotton/Poly Blends  
Lycra®/Spandex • Polypropylene

Express Print	
Part No.	Size
MC200XPT001-5	20" x 5 yard
MC200XPT001-10	20" x 10 yard
MC200XPT001-25	20" x 25 yard
MC300XPT001-5	30" x 5 yard
MC300XPT001-10	30" x 10 yard
MC300XPT001-25	30" x 25 yard
MC540XPT001-5	54" x 5 yard
MC540XPT001-10	54" x 10 yard
MC540XPT001-25	54" x 25 yard

**RECOMMENDED MASK:**  
Medium Tack Magic Mask®

See pages 216-229  
for heat presses



Heat Transfer Material

**NEW CAD-COLOR® Soft Opaque II**

New and improved printable material that is light and soft to the touch. Enjoy fast production with a low application temp of only 250° F. Thin and stretchable, Soft Opaque II is ideal for a variety of fabrics and will stretch along with them. Its superior opacity means the colors will stay bright and stand out on even the darkest garments.

**Heat Press Temp:** 250° F/121° C  
**Peel:** Hot

**Time:** 5-7 seconds  
**Pressure:** Medium (4 - 6)

See pages 216-229  
for heat presses

**MATERIAL COMPATIBILITY**

Cotton • Polyester  
Cotton/Poly Blends • Lycra®/Spandex

Soft Opaque II	
Part No.	Size
MC200SO2001-5	20" x 5 yard
MC200SO2001-10	20" x 10 yard
MC200SO2001-25	20" x 25 yard
MC300SO2001-5	30" x 5 yard
MC300SO2001-10	30" x 10 yard
MC300SO2001-25	30" x 25 yard

**RECOMMENDED MASK:**  
Medium Tack Magic Mas



Pressure Chart	
LIGHT	1 - 3
MEDIUM	4 - 6
FIRM	7 - 9

**NEW** CAD-COLOR® SUPERTEK® Sublistop™



Inhibit bleed-through with a material designed to inhibit dye migration. A charcoal-based liner and patented STIX2™ adhesive keep transfers vibrant and true on sublimated and brightly colored polyester garments. Lightweight, with a soft hand, semi-matte finish, excellent stretch and rebound; this material has a low application temp of 280° F to 300° F to avoid scorching heat-sensitive performance fabrics.

**Heat Press Temp:** 280° F-300° F/138°-150° C  
**Peel:** Warm

**Time:** Tack 5 seconds, peel, cover & seal 5 seconds  
**Pressure:** Medium (4 - 6)

**MATERIAL COMPATIBILITY**

- Cotton • Polyester • Cotton/Poly Blends
- Lycra®/Spandex • Nylon • Cordura®
- Leather • Neoprene

SuperTEK Sublistop	
Part No.	Size
MC200SSU001-5	20" x 5 yard
MC200SSU001-10	20" x 10 yard
MC200SSU001-25	20" x 25 yard
MC400SSU001-25	40" x 25 yard

**RECOMMENDED MASK:**  
 Solutions® Mask

See pages 216-229  
 for heat presses

Pressure Chart	
LIGHT	1 - 3
MEDIUM	4 - 6
FIRM	7 - 9



**NEW** CAD-COLOR® SUPERTEK® Opaque

Create stunning full color transfers for dark garments. With excellent opacity, stretch and rebound plus a low application temperature, it's perfect for stretchy heat-sensitive performance fabrics. Patented STIX2™ adhesive applies to almost any fabric. SUPERTEK Opaque delivers a semi-matte finish and incredibly soft hand.

**Heat Press Temp:** 280° F-300° F/138°-150° C  
**Peel:** Warm

**Time:** Tack 5 seconds, peel, cover & seal 5 seconds  
**Pressure:** Medium (4 - 6)

**MATERIAL COMPATIBILITY**

- Cotton • Polyester • Cotton/Poly Blends
- Lycra®/Spandex • Nylon • Cordura®
- Leather • Neoprene

SuperTEK Opaque	
Part No.	Size
MC200SOP120-5	20" x 5 yard
MC200SOP120-10	20" x 10 yard
MC200SOP120-25	20" x 25 yard
MC400SOP120-25	40" x 25 yard

**RECOMMENDED MASK:**  
 Solutions® Mask

See pages 216-229  
 for heat presses



Heat Transfer Material



**NEW CAD-COLOR® SUPERTEK® Matte/Gloss Clear**



Superior finishes for white or light fabrics. Masks aren't needed when you use this print HTV. With exceptional stretch and rebound properties plus a low application temperature and the patented STiX2™ adhesive, this printable material is perfect for performance garments.

**Heat Press Temp:** 280° F-300° F/138°-150° C  
**Peel:** Cold, cover & seal 5 seconds

**Time:** Tack 5 seconds, peel, cover & seal 5 seconds  
**Pressure:** Medium (4 - 6)  
**Print Directions:** Mirror

**MATERIAL COMPATIBILITY**  
 Cotton • Polyester • Cotton/Poly Blends  
 Lycra®/Spandex • Nylon

*See pages 216-229 for heat presses*

SuperTEK Clear		
Matte Part No.	Gloss Part No.	Size
MC200SMA000-5	MC200SGL000-5	20" x 5 yard
MC200SMA000-10	MC200SGL000-10	20" x 10 yard
MC200SMA000-25	MC200SGL000-25	20" x 25 yard



Pressure Chart	
LIGHT	1 - 3
MEDIUM	4 - 6
FIRM	7 - 9

Heat Transfer Material





**NEW** CAD-COLOR® Glitter



Print full color bling designs with a unique glitter/shimmer finish that is ideal for decorating fashion, cheer and fan wear.

**Heat Press Temp:** 302° F/150° C  
**Peel:** Hot

**Time:** 12 seconds  
**Pressure:** Medium (4 - 6)



**MATERIAL COMPATIBILITY**  
 Cotton • Polyester • Cotton/Poly Blends

Glitter	
Part No.	Size
MC200GLR001-5	20" x 5 yard
MC200GLR001-10	20" x 10 yard
MC200GLR001-25	20" x 25 yard

**RECOMMENDED MASK:**  
 High Tack Magic Mask®

See pages 216-229  
 for heat presses



**NEW** CAD-COLOR® Soft Foam

Create full color dimensional designs that add a raised effect to any item. With a smooth, velvet-like texture Soft Foam is perfect for creating premium looks for everyday fashion, spirit wear, athletics and more. Due to the porous texture of the material, printed designs will have a matte finish with soft, muted colors.

**Heat Press Temp:** 302° F/150° C  
**Peel:** Hot

**Time:** 15 seconds  
**Pressure:** Light/Medium (3 - 4)



**MATERIAL COMPATIBILITY**  
 Cotton • Polyester • Cotton/Poly Blends

Soft Foam	
Part No.	Size
MC200SOM001-5	20" x 5 yard
MC200SOM001-10	20" x 10 yard
MC200SOM001-25	20" x 25 yard

**RECOMMENDED MASK:**  
 Medium Tack Magic Mask®

See pages 216-229  
 for heat presses

Pressure Chart	
LIGHT	1 - 3
MEDIUM	4 - 6
FIRM	7 - 9



Heat Transfer Material



Heat Transfer Material

**SOLUTIONS® Masks**

Easily pull printed transfers from the carrier with this mask and transfer them to the garment for application. Just peel the mask off the carrier, squeegee over weeded design, peel mask to remove printed design and place the design on your substrate or garment. Recommended for use with TEK™ printable materials.

<i>Solutions</i>	
Part No.	Size
MC230SMM000-10	23" x 10 meter
MC230SMM000-20	23" x 20 meter
MC400SMM000-25	40" x 25 yard

**MAGIC MASK® – Medium Tack**

Recommended for CAD-COLOR Express Print, Soft Foam and Soft Opaque II. Transfer designs cut on your vinyl cutter from the HTV carrier to the substrate. Medium tack mask is designed for materials with medium thickness and weight.

<i>Magic Mask - Medium Tack</i>	
Part No.	Size
MC150STM000-10	15" x 10 yard
MC150STM000-25	15" x 25 yard
MC200STM000-5	20" x 5 yard
MC200STM000-10	20" x 10 yard
MC200STM000-25	20" x 25 yard
MC300STM000-10	30" x 10 yard
MC300STM000-25	30" x 25 yard

**MAGIC MASK® – High Tack**

Best used on fabrics like CAD-COLOR Glitter. High tack allows you to remove and transfer thicker materials.

<i>Magic Mask - High Tack</i>	
Part No.	Size
MC200M15000-10	20" x 10 yard
MC200M15000-25	20" x 25 yard



# Sef FlexCut MAXX Heat Transfer Material

Ignite your business with the best performing line from Sef Americas. The Flexcut MAXX series is a polyurethane material that boasts an impressive array of high-quality colors. All of these colors will weed quickly and easily. The exceptionally thin profile feels even softer, yet durable enough to withstand multiple washings. Use this material with most fabrics including cotton and poly/cotton blends. CPSIA Compliant.

**Heat Press Temp:** 330° F/165° C  
**Peel:** Hot/Warm  
**Time:** 15-17 Seconds  
**Pressure:** Medium: Cotton, Medium/High: Polyester  
**Cut Direction:** Reverse  
**Washing:** Warm 140° F/60° C  
**Thickness:** 2.4 mil

	<b>001</b> White		<b>039</b> Yellow Neon		<b>041</b> Pink Neon		<b>042</b> Green Neon		<b>017</b> Sky Blue
	<b>002</b> Black		<b>047</b> Dent-De-Lion Yellow		<b>033</b> Passion Red		<b>035</b> Vibrant Green		<b>018</b> Atoll Blue
	<b>031</b> Silver Metallic		<b>005</b> Lemon Yellow		<b>010</b> Red		<b>024</b> Apple Green		<b>050</b> Sweet Blue
	<b>014</b> Cool Grey		<b>006</b> Sunny Yellow		<b>011</b> Fire Red		<b>036</b> Light Green		<b>019</b> Pacific Blue
	<b>015</b> Grey		<b>007</b> Orange		<b>012</b> Electric Red		<b>025</b> Green		<b>020</b> Reflex Blue
	<b>016</b> Dark Grey		<b>040</b> Orange Neon		<b>013</b> Burgundy		<b>026</b> Military Green		<b>021</b> Royal Blue
	<b>004</b> Brown		<b>048</b> Soda Orange		<b>049</b> Moon Berry		<b>044</b> Mint Green		<b>022</b> Navy Blue
	<b>032</b> Metallic Gold		<b>008</b> Baby Pink		<b>037</b> Lavender		<b>034</b> Turquoise		<b>023</b> Purple
	<b>003</b> Beige		<b>043</b> Candy Pink		<b>038</b> Plum				
	<b>045</b> Dune Beige		<b>009</b> Fuchsia		<b>046</b> Lavender Blue				

FlexCut Maxx Colors, Metallic & Neon	
Size	
15" x 5 yard	
15" x 10 yard	
15" x 25 yard	
15" x 50 yard	

  

FlexCut Maxx 001 White & 002 Black	
Size	
19.7" x 5 yard	
19.7" x 10 yard	
19.7" x 25 yard	
19.7" x 50 yard	

**Note: Some items may ship directly from manufacturer.**  
**Note: Colors shown are approximate.**

See pages 216-229 for heat presses

- Processing Tip:**
- Reverse Cut on Dull Side
  - No Application Tape Needed
  - Testing is Recommended Before Moving Into Full Production

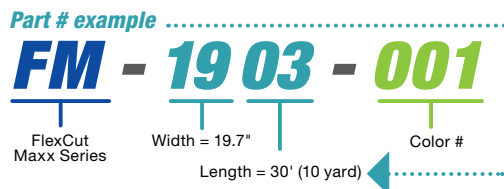

Width and Length					
Part number codes for the second four (4) digits					
Width	5 yard	10 yard	25 yard	50 yard	
15"	1502	1503	1508	1515	
19.7"	1902	1903	1908	1915	

Heat Transfer Material



### Sef FlexCut SBB

This material is essential when applying graphics to dyed materials. The sublimation-blocking barrier (SBB) is formulated to block any ink migration into the heat transfer material. Without this key feature, heat-applied graphics will take on a light hue of the color material it's applied to. The material also has great opacity when applied to patterned material.

**Heat Press Temp:** 265° F/129° C  
**Peel:** Cold  
**Time:** 10 Seconds  
**Pressure:** Medium/High  
**Cut Direction:** Mirror  
**Thickness:** 4.7 mil

Part No.	Width	Length
5204050	19.7"	5 meter
5204055	19.7"	10 meter

See pages 216-229 for heat presses



Heat Transfer Material

### Sef Tatoo SBB

Use this material when heat-applying printed graphics to dyed fabrics. The film has a sublimation-blocking barrier (SBB) formulated to block ink migration into the heat transfer material. Without this key feature, heat-applied graphics will take on a light hue of the color material its applied to. The material also has great opacity when applying to patterned material.

**Heat Press Temp:** 275° F/135° C  
**Peel:** Cold  
**Time:** 10 Seconds  
**Pressure:** Medium/High  
**Print Direction:** Right Reading  
**Thickness:** 3.9 mil

Part No.	Width	Length
5208650	19.7"	5 meter
5208655	19.7"	10 meter



## Sef FlexCut Atomic Heat Transfer Material

FlexCut Atomic is a semi-metallic film with a pearlescent finish. Easy to cut and weed, Atomic is 100% polyurethane and available in seven unique colors. Like other FlexCut products, Atomic offers an exceptionally thin profile for a softer feel yet it is durable to withstand multiple washings. Use on most fabrics including cotton and poly/cotton blends. CPSIA compliant.



**Heat Press Temp:** 330° F/165° C  
**Peel:** Hot/Warm  
**Time:** 15-17 Seconds

**Pressure:** Medium: Cotton, Medium/High: Polyester  
**Cut Direction:** Mirror  
**Washing:** Warm 140° F/60° C  
**Thickness:** 2.4 mil

<b>001</b> Pink			<b>003</b> Orange/Copper		<b>005</b> Blue		<b>007</b> Cherry
<b>002</b> Red			<b>004</b> Green		<b>006</b> Purple		

FlexCut Atomic
Size
19.7" x 5 yard
19.7" x 10 yard
19.7" x 25 yard
19.7" x 50 yard

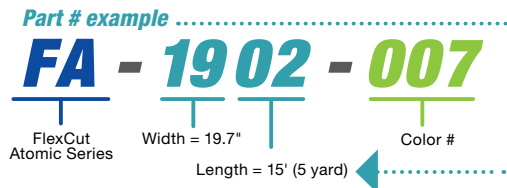

- Processing Tip:**
- Reverse Cut on Dull Side
  - No Application Tape Needed
  - Testing is Recommended Before Moving Into full production



**Note:** Some items may ship directly from manufacturer.  
**Note:** Colors shown are approximate.

## Sef FlexCut Nylon Heat Transfer Material

Designed for use on nylon and coated materials, FlexCut Nylon sets at 240° F. Testing is recommended on nylon fabrics which may be color-sensitive. When using cotton and cotton/poly blends, results may vary depending on fabric composition and the production environment. CPSIA compliant.



**Heat Press Temp:** 240° F/115° C  
**Peel:** Hot/Warm  
**Time:** 15 Seconds

**Pressure:** Medium  
**Cut Direction:** Mirror  
**Washing:** Warm 104° F/40° C  
**Thickness:** 2.8 mil

<b>001</b> White			<b>005</b> Lemon Yellow		<b>021</b> Royal Blue		<b>031</b> Silver Metallic
<b>002</b> Black			<b>010</b> Red		<b>025</b> Green		<b>032</b> Gold Metallic

FlexCut Nylon
Size
15" x 5 yard
15" x 10 yard
15" x 25 yard
15" x 50 yard

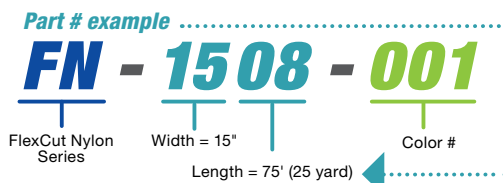

- Processing Tip:**
- Reverse Cut on Dull Side
  - No Application Tape Needed
  - Testing is Recommended Before Moving Into Full Production



Width and Length				
Part number codes for the second four (4) digits				
Width	5 yard	10 yard	25 yard	50 yard
15"	1502	1503	1508	1515
19.7"	1902	1903	1908	1915



## Sef FlexCut MetalFlex Heat Transfer Material

MetalFlex is a very thin, shiny and stretchable film, made with 100% polyurethane. Available in nine colors, it offers excellent washing durability. Use on most fabrics including cotton and poly/cotton blends. CPSIA compliant.

**Heat Press Temp:** 340° F/171° C  
**Peel:** Warm  
**Time:** 20 Seconds  
**Pressure:** Medium: Cotton, Medium/High: Polyester  
**Cut Direction:** Mirror  
**Washing:** Warm 140° F/60° C  
**Thickness:** 1.6 mil

<b>001</b> Silver		<b>003</b> Red	<b>005</b> Green		<b>007</b> Gun Metal
<b>002</b> Gold		<b>004</b> Blue	<b>006</b> Orange/Copper		<b>008</b> Rose
					<b>009</b> Rose Gold



FlexCut MetalFlex Size
15" x 5 yard
15" x 10 yard
15" x 25 yard
15" x 50 yard

Part # example

**MF - 15 15 - 007**

FlexCut  
MetalFlex  
Series

Width = 15"

Length = 150' (50 yard)

Color #

Did you know?



Processing Tip:

- Reverse Cut on Dull Side
- No Application Tape Needed
- Testing is Recommended Before Moving Into Full Production

*Note: Colors shown are approximate.*

Heat Transfer Material

## Sef ReflexCut Reflective Heat Transfer Material



ReflexCut is reflective heat transfer film made with unique polyurethane and micro bead construction. ReflexCut is available in eight popular colors. Use on most fabrics including cotton, polyester and poly/cotton blends. Silver is safety grade and meets safety code EN ISO 20471. CPSIA compliant.

**Heat Press Temp:** 302° F/150° C  
**Peel:** Cold  
**Time:** 15-17 Seconds  
**Pressure:** Medium/High  
**Cut Direction:** Mirror  
**Washing:** Warm 140° F/60° C  
**Thickness:** 5.9 mil

<b>001</b> Silver		<b>003</b> Red	<b>005</b> Blue		<b>007</b> Neon Pink
<small>(Safety grade, meets EN471 Class-2)</small>					
<b>002</b> White		<b>004</b> Neon Yellow	<b>006</b> Gold		<b>008</b> Black

ReflexCut Size
19.7" x 5 meter
19.7" x 10 meter
19.7" x 25 meter



Part # example

**RC - 19 08 - 001**

ReflexCut  
Series

Width = 19.7"

Length = 75' (25 yard)

Color #

Width and Length  
Part number codes for the second four (4) digits

Width	5 yard	10 yard	25 yard	50 yard
15"	1502	1503	1508	1515
19.7"	1902	1903	1908	1915

Processing Tip:

- Reverse Cut on Dull Side
- No Application Tape Needed
- Testing is Recommended Before Moving Into Full Production



## Sef Graffiti Print Heat Transfer Material

Graffiti is an intermediate high performance print & cut heat transfer material. It is a polyurethane film with a co-polyester adhesive. Use it with Latex, eco-solvent & solvent inks. Graffiti delivers excellent color retention, stretch and washing durability. Use on most fabrics including cotton and poly/cotton blends. It may be color sensitive on polyester. CPSIA compliant.



**Heat Press Temp:** 265° F/129° C  
**Peel:** Hot/Warm  
**Time:** 20 Seconds

**Pressure:** Medium/High  
**Print Direction:** Right Reading  
**Washing:** Warm 140° F/60° C  
**Thickness:** 2.4 mil



Part No.	Width	Length
5207150	19.7"	5 yard
5207155	19.7"	10 yard
5207165	19.7"	25 yard
5207168	19.7"	50 yard
5207250	29.5"	5 yard
5207255	29.5"	10 yard
5207265	29.5"	25 yard
5207268	29.5"	50 yard
5207395-54	54"	25 yard
5207398-54	54"	50 yard
5207395-60	60"	25 yard
5207398-60	60"	50 yard



**Processing Tip:**

- Right Reading Cut on Dull Side
- Need Flex Tape to Apply Graphic
- Testing is Recommended Before Moving Into Full Production
- Print Side Out

See pages 216-229 for heat presses

## Sef FlexTape Plus with Liner

FlexTape is a transparent polyester film, coated with an acylate adhesive on a silicone paper carrier with medium adhesion properties. The specially prepared adhesive is able to transfer heat-sealable scripts and motifs, Graffiti and other flex-films onto textiles. Be sure ink is dry when transferring printed films to ensure designs do not smudge. FlexTape has excellent resistance to temperature, aging and UV exposure. It can be removed completely without trace even after a longer adhesion period. CPSIA compliant.



**Carrier:** Polyester Film/Transparent  
**Liner:** Silicone Paper

**Adhesive:** Acylate  
**Thickness:** 0.100 mm



Part No.	Width	Length
5212500	20"	10 yard
5212505	20"	25 yard
5212510	20"	50 yard
5212520	30"	10 yard
5212525	30"	25 yard
5212530	30"	50 yard

Heat Transfer Material



# Tools & Tapes

*if you're looking for:*

**ROTARY TRIMMERS**

**SAFETY RULERS & TABLE MATS**

**CUTTERS, KNIVES & REPLACEMENT BLADES**

**WEEDING TOOLS**

**INSTALLATION TOOLS**

**HEAT GUNS**

**MAGNETS**

**SQUEEGEES, BUFFERS & GLOVES**

**MEDIA RACKS, CLIPS & STRAPS**

**RAPID TAC & WRAP CARE PRODUCTS**

**MOUNTING TAPE**

plus

tesa<sup>®</sup> ACX<sup>plus</sup>

tesa<sup>®</sup> ACX<sup>plus</sup>

tesa<sup>®</sup> ACX<sup>plus</sup>



## Professional Rotary Trimmers

A precision trimmer that will cut most flexible materials up to a thickness of 3.0 mil.



**RTM60120**  
18" Rotatrim Pro Trimmer

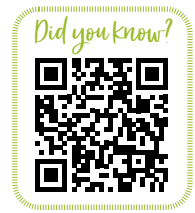

**RTM60130**  
24" Rotatrim Pro Trimmer



**RTM60150**  
36" Rotatrim Pro Trimmer

**5 Year Limited Warranty**

Call for Details



**RTM60170**  
54" Rotatrim Pro Trimmer

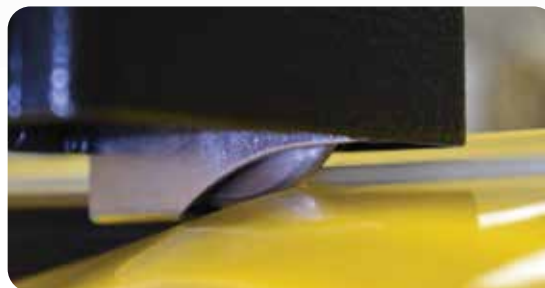

**RTM69105**  
Replacement  
Rotatrim Pro Trimmer  
Cut Wheel

Tools



## Safety Rulers

Heavy duty aluminum construction with curved finger guard for max protection.

### Sooper Edge

The Sooper Edge is a premier safety ruler in the sign and graphics industry. Permanent black finish is chip resistant and easy to find in any shop. Stainless steel inserted edge eliminates cutting into the ruler, providing maximum performance and lifetime use.



Sooper Edge	
Part #	Description
ESL28B	28" Safety Ruler
ESL40B	40" Safety Ruler
ESL52B	52" Safety Ruler
ESL96B	96" Safety Ruler

NOTE: Additional shipping charge applies on 96" Safety Ruler.



Bottom non-slip grip & stainless steel edge

### Big Blue

Big Blue Safety Ruler is the one choice for the finishing room. Permanent blue finish is chip resistant and easy to find in any shop.



The Big Blue	
Part #	Description
ECSL28	28" Safety Ruler
ECSL40	40" Safety Ruler
ECSL52	52" Safety Ruler
ECSL96	96" Safety Ruler

NOTE: Additional shipping charge applies on 96" Safety Ruler.

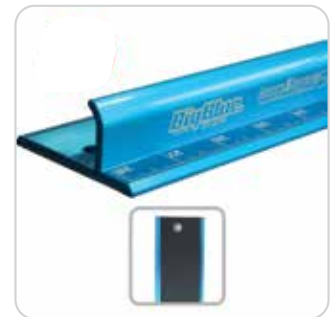

Bottom Non-Slip Grip

## FoamWerks Straight Cutter

FoamWerks Straight Cutter features adjustable blade depth, quick change blade clip, magnetic blade slot, on-board blade storage drawer and five blades. Cut perfect straight edges on any depth from 1/8" to 1/2". Works great for trimming banner material and self-adhesive vinyl.



WC6001  
Straight Cutter

**Works with both our Sooper Edge and Big Blue Safety Rulers!**



### Replacement Blades



WC20  
Replacement  
Blade C for  
WC6001, 20 Pack



## Xtreme Cutting Mats

Xtreme mats are made from an extremely tough high impact polymer blend. These mats are great for protecting your table top and extending the life of your cutting blades.

**CM48**

Cutting Mat  
Size: 4' x 8'

**CM510**

Cutting Mat  
Size: 5' x 10'



Xtreme Cutting Mats are Semi-Translucent.

## Grids

Easily add an alignment grid under your semi-translucent non-printed cutting mat with this easy to use grid underlayment.

**CM48G**

Grid  
Size: 4' x 8'

**CM510G**

Grid  
Size: 4' x 6'  
(Consists of 3 pieces)

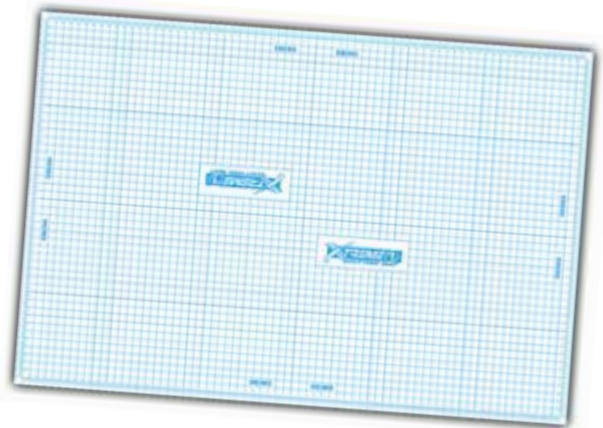

## Coro Claws

Stop struggling to cut fluted plastic sheets and start using the uniquely designed Coro Claw! The tool's unique design fits directly into the flute. The tool is pulled through the sheet cutting cleanly through the entire board. The tool can also be used to cut out the backside of flutes to create clean perfect looking corners every time.



**CCD4**  
4mm Coro Claw Deluxe



**CCX**  
10mm Coro Claw X



## PROSERIES PROKNIFE

30 degree, 9mm snap blade is ideal for car wrap installations. The PROKNIFE is the premier choice among professionals in the graphics industry.



**PSPKBR**  
PROKNIFE Lock Blade  
30 Degree  
9mm Snap Blade

## PROSERIES

"Tools for Artists, by Artists"



**PSPB-R10**  
30 degree, 9mm PROKNIFE  
Replacement blades  
10 pack. Fits PSPKBR

## Premium Cutter

A strong, durable, metal casing that holds 30° angled breakaway blades for accurate cutting.



**A013190**   
Premium Cutter



## Breakaway Application Knife

Plastic applicator knife designed for graphic application. Holds 30° angled breakaway blade for accurate cutting.



**A013183**   
Breakaway  
Application Knife

### Replacement Blades



**EX20030**  
30° Snap Blade  
10 Pack



**EX22630**  
30° Snap Blade  
100 Pack



**A1160B**  
10 Pack, 30°  
Snap-Off  
Graphics Blades

## Snitty Vinyl Cutter

Snitty Vinyl Cutter is a mini-slitting tool. Handy for cutting self-adhesive material.



**A013181**  
Snitty Vinyl Cutter

### Replacement Blades

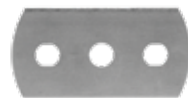

**LCB10**  
10 Pack, Snitty Vinyl Cutter  
Tool Replacement Blades

**WARNING**  
CANCER AND REPRODUCTIVE HARM  
www.P65Warnings.ca.gov

**Avery Dennison® Products**  
Avery Dennison® Products can  
**ONLY** be distributed to customers  
in the United States and US  
Territories.



## Sign Tools

### K850 Plastic Body Snap Blade Knife



**EX16850**  
18mm, 59 Degree  
Heavy Duty Knife



**EX20007**  
18mm, 59 Degree  
Replacement Snap Blades  
5 Pack



**EX22607**  
18mm, 59 Degree  
Replacement Snap Blades  
100 Pack

### K1 Aluminum Knife

The Excel K1 Knife is great for precision cutting, trimming, and stripping of paper, plastic, wood, cloth, and film. The light weight body fits with all standard craft knife blades. It includes 4 aluminum chuck jaws for a more secure blade positioning and hold than your standard light duty knife. The shatter resistant safety cap protects the blade during storage.



**EX16001**  
K1 Knife  
with Safety Cap

### K18 Grip on Knife

The Excel K18 Knife has a light weight, aluminum body with a comfortable soft grip handle. It fits all standard knife blades. It includes 4 aluminum chuck jaws with rear blade release for a more secure blade and hold than your standard light duty knife. The shatter resistant safety cap protects the blade during storage.



**EX16019**  
K18 Grip Blue Knife  
with Safety Cap

### K26 Fit Grip Knife

The Excel K26 Knife includes a rubberized soft exterior that encases a strong aluminum body and four chuck jaws with rear blade release for a more secure blade placement. The handle fits all standard knife blades. It includes a shatter resistant safety cap to protect blade during storage.



**EX16026**  
K26 Black Fit  
Grip Knife

#### K1, K18 & K26 Replacement Blades



**EX20011**  
#11 Double Honed  
Blade  
5 Pack



**EX22611**  
#11 Double Honed  
Blade  
100 Pack



## Sign Tools

### Dual Flex Cutter A

The Excel Dual Flex Cutter A is an aluminum knife with two parallel #59 blades with adjustable widths. The width is adjusted by tightening or loosening the screw. Width size adjusts from .12" - .63"

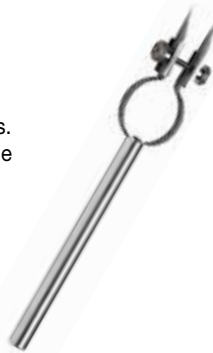

**EX70031**  
Dual Flex  
Cutter A

### K73 Snap Blade Knife

A colorfully sturdy snap blade handle housing a durable and sharp 30° blade. The handle has an updated rounded edge in order to make angle transition seamless. Perfect tool for graphic artists, designers and arts and crafts applications: wood carving, scrapbooking, model kits, paper crafts and more.

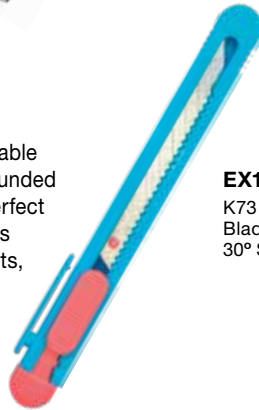

**EX16073**  
K73 Blue/Pink Snap  
Blade Knife with  
30° Snap Blade

### K70 Slim Snap Blade Knife

Perfect light duty utility knife with 13 point snap blade that cuts through cardboard packages, ropes, canvas, paper, plastic, wood and more. Light weight, slim blade and metal frame with adjustable depth allows for versatility and comfort. 13 point snap blade acts as 13 separate blades for a long lasting perfect cut. Metal reinforced blade support for extra stability with locking screw that allows for precise blade positioning. Includes (1) slim metal frame body with (1) #3 13 point snap utility blade.

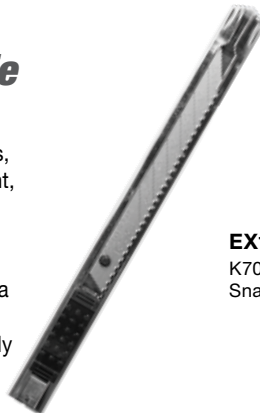

**EX16070**  
K70 Slim  
Snap Blade Knife

#### K73 & K70 Replacement Blades



**EX20030**  
30° Snap Blade  
10 Pack



**EX22630**  
30° Snap Blade  
100 Pack

### K11 Metal Safety Scraper

The Excel K11 Metal Safety Scraper is perfect for removing paint or stickers and decals from glass windows and doors. The blade is retractable to protect it during storage. The heavy duty metal frame makes sure your blade is sturdy and secure for safe, reliable use. A rust resistant coating allows for premium performance during extended periods of heavy usage. Fits all standard size razor blades.



**EX16011**  
K11 Metal  
Safety Scraper  
with 6 Blades



#### Replacement Blades

**EX20009**  
.009" Single Edge  
Razor Blade  
10 Pack





## Complete Weeding Kit

This high quality kit includes five different angled 6" stainless steel hand tools with chrome handles for picking and weeding. These tools are ideal for a variety of materials, such as Cast, Calendered, Heat Transfer materials and more.



**CWK**  
5 Tool Complete Weeding Kit

Tools

## Retractable Weeding & Bubble Popping Tools

Aluminum retractable weeding pen with pocket clip. Also works great as a marking point for leather, paper, wood, plastic, and more.



**EX16051**  
.030" Gauge Retractable Weeding Tool



**EX16050**  
.090" Gauge Retractable Weeding Tool



**EX16049**  
.060" Gauge Retractable Weeding Tool

## Kota Pro™ Liner Cutters

**KOTA**<sub>PRO</sub>

Designed specifically to only cut the liner on most self-adhesive films, this tool is something every installer needs. With a large graphic, the dual liner cutter can be used to create a hinge in one swipe. Longer handles help the installer keep a better grip on the knife. Use a Teflon pad on the guide of the knife when working with stubborn films.



**LC2**  
10mm Elite Liner Cutter



*Ergonomic design and teflon coated!*



Front of Dual Cutter



**LC3**  
10mm Elite Dual Cutter

### Replacement Blades & Pad

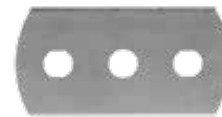

**LCB10**  
10 Pack, Liner Cutting  
Tool Replacement Blades  
(works for LC1, LC2 and LC3)



**PAD**  
2 Pack, Liner Cutting  
Tool Replacement Pad



## Multi-Blade Auto-Loading Auto-Lock Utility Knife with Blade Storage

This knife is ideal for sign materials and packages. Knife holds up to five snap-off blades and comes pre-loaded with two ABB black, ultra-sharp snap-off blades. **Uses standard duty blades AB, ABB and A-SOL10B.**



**PA-2**  
Auto-Loading Utility Knife  
with Blade Storage



## Auto-Lock Utility Knife with Blade Snapper

This knife is ideal for sign materials and packages. Apply firm finger pressure to open and close the knife. Blades can easily be snapped off with the built-in snapper tool. Knife comes pre-loaded with two AB silver snap-off blades. **Uses standard duty blades AB, ABB and A-SOL10B.**



**A-1**  
Utility Knife with  
Blade Snapper

## Stainless Steel Slide-Lock Utility Knife

Slim design, features a slide lock and pocket clip/blade snapper. Knife comes pre-loaded with two AB silver snap-off blades. **Uses standard duty blades AB, ABB and A-SOL10B.**



**SVR-1**  
OLFA Deluxe Stainless  
Steel Cutter

## Stainless Steel Body Auto-Lock Utility Knife with Blade Snapper

Designed for damp environments where rust is a concern, this knife provides an automatic lock for extra control and safety. Some other great features are a built-in pocket clip and blade snapper. This knife allows for right and left handed usage; it is ideal for sign making and graphic artists. Knife comes pre-loaded with two AB silver snap-off blades. **Uses standard duty blades AB, ABB and A-SOL10B.**



**SVR-2**  
OLFA Stainless Steel  
Auto-Lock Utility Knife

### AB, ABB and A-SOL Replacement Blades



**AB-10B**  
10 Pack, 9mm  
59° Snap-Off Blades

**AB-50B**  
50 Pack, 9mm  
59° Snap-Off Blades



**ABB-10B**  
10 Pack, 9mm  
59° Ultra-Sharp  
Snap-Off Black Blades

**ABB-50B**  
50 Pack, 9mm  
59° Ultra-9mm  
Snap-Off Black Blades



**A-SOL10B**  
10 Pack, 9mm  
59° Solid Blade

A-SOL10B can be used with any OLFA 9MM knife.



### Stainless Steel Snap-Off Graphics Knife

This cutter is ideal for sign making and graphic artists. It has an acute 30° angle allowing you to easily cut foam board, gator board, coroplast, plastics and more. **Uses standard duty blades A1160B.**



**SAC-1**  
OLFA Ultra-Slim Cutter



#### Replacement Blades

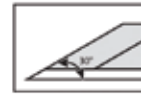

**A1160B**  
10 Pack, 30°  
Snap-Off  
Graphics Blades

### Top Sheet Cutter

Made from high-quality carbon tool steel. Auto-pressure control system adjusts cutting pressure. Used to cut only the liner and not the film. **Uses TSB-1 blades.**



**TS-1**  
OLFA Top Sheet  
Cutter

#### Replacement Blades



**TSB-1**  
5 Pack, Top Sheet Cutter  
Replacement Blades

### 90-Degree Cutting Base Ratchet-Lock Utility Knife

Designed with a ratchet-lock mechanism and high-impact ABS handle. It features a 90-degree flat cutting base with built-in adjustable stainless steel guide and staple remover. The snap-off blade has eight cutting edges to make every project quicker and more economical. Ideal for cutting cardboard, coroplast, foam board and gator board. **Uses heavy duty blades LB, LBB and LFB.**



**CL9021**  
90-Degree  
Utility Knife with  
Ratchet-Lock



#### LB and LFB Replacement Blades



**LB-10B**  
10 Pack, 18mm  
59° Snap-Off Blades

**LB-50B**  
50 Pack, 18mm  
59° Snap-Off Blades



**LBB-10B**  
10 Pack, 18mm  
59° Ultra-Sharp  
Snap-Off Black Blades

**LBB-50B**  
50 Pack, 18mm  
59° Ultra-Sharp  
Snap-Off Black Blades



**LFB-10B**  
10 Pack, 18mm  
59° Snap-Off Speed Blades

### Pistol Grip Ratchet-Lock Utility Knife

Designed with a double-honed blade for superior sharpness and edge retention. This knife provides a ratchet-lock mechanism to give you multiple blade positions. Some other great features are a built-in pocket clip and blade snapper. This knife is great for cutting heavier materials, such as cardboard and plastic. **Uses heavy duty blades LB, LBB and LFB.**



**L-1**  
Utility Knife with  
Ratchet-Lock

Tools

## Plastic / Laminate Cutter

Designed with a wheel-lock mechanism and high-impact ABS handle. This cutter has an aluminum die cast blade slider and is designed to score materials in order to effectively cut sheet plastics, plexiglass and laminates. **Uses PB-800 blades.**



**PC-L**  
Plastic / Laminate Cutter



Includes 1 reversible tungsten steel PB-800 blade inserted PLUS 2 replacement blades in the handle



### Replacement Blades



**PB-800**  
3 Pack,  
Plastic / Laminate  
Blades

## Cushion Grip Knife

Designed with an anti-slip cushion grip, acetone-resistant handle, this knife is ideal for professionals. It also features an anti-roll design for added safety and is perfectly balanced for right and left hand users. **Uses KB4-S100 precision art blades.**



**AK-4**  
OLFA Cushion  
Grip Knife

### Replacement Blades



**KB4-S100**  
100 Pack, Precision Art  
Replacement Blades

Tools

## Blade Disposal Can

Handy pocket size can allows for quick and safe snap-off disposal of OLFA standard and heavy duty blades.



**DC-3**  
Blade Disposal Can



Shown Closed



## Blade Disposal

Disposes single-edge utility knife and snap-off blades, holds approximately (30) 2-sided utility blades and up to 200 snap-off blades.



**DC-4**  
Blade Disposal



## Glass Scraper

This scraper features a durable, lightweight, multi-grip handle with a high quality stainless steel blade and safety blade cover. The low profile handle allows you to angle in close on a flat surface. Great for scraping adhesives, films, paint, dirt and much more.



Detachable Safety Blade Cover Slides Over Handle for Added Grip.

**GSR-13B**  
Multi-Grip Glass Scraper Includes Four Stainless Steel Blades

Lanyard not included



**GSB-1S**  
30 Pack, Multi-Grip Glass Scraper Replacement Blade 4.7" / 120mm







## RollePro Vinyl Application Roller

Designed to quickly roll over vinyl covered rivets and contours. This vinyl applicator has an ergonomic design and heat resistant wheel that adds speed and comfort to the application process.



**RP-VAR-1001**  
RollePro Vinyl Application Roller



**RP-RW-1002**  
RollePro Vinyl Application Roller Replacement Wheel



**RP-RTW-1009**  
RollePro High Temp Vinyl Application Roller for Textured Surfaces

Tools



### Customer Testimonial



“ The soft roller worked amazing! I used it along with a heat gun to mush my wrap stencils into the crevasse of concrete block to paint this wall. No touch-ups needed! Thank you! ”

- Dan Gall  
Sign Blazer, Lakeville, NY

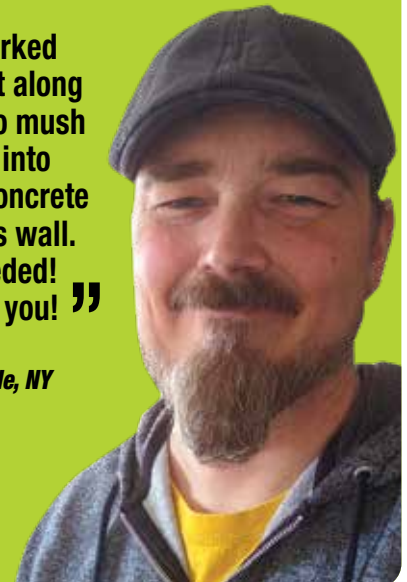

## 3M™ Knifeless Tape

Install custom designs safely to the surface of a vehicle with this innovative product from 3M. Knifeless tape utilizes a thick filament embedded in a thin flexible tape to cut graphics cleanly without cutting on a car! Simply apply tape to the surface in the desired shape, pattern or design, and then apply your vinyl over the top. Pull the filament through the vinyl and remove the unwanted vinyl, leaving behind a perfectly cut edge, every time.

### Design Line Knifeless Tape

- Size 3.5mm
- Patented design allows you to slightly stretch and easily turn in any direction.
- For faster application the tape can be broken with your hands.
- Easily create highly contoured designs with a sharp, clean edge.
- Ideal for single layer vinyl applications.



**KTS-DL1**  
3.5mm x 50m  
Design Line Knifeless Tape

### Finish Line Knifeless Tape

- Size 3.5mm
- Patented design allows you to follow contours and curves in any direction.
- Use for wrap applications, cuts most vinyl wrap films easily.
- For faster application the tape can be broken with your hands.
- Great for finishing vehicle graphic installations without a blade.
- Ideal for use around door handles, bumpers, and mirrors.



**KTS-FL1**  
3.5mm x 50m  
Finish Line Knifeless Tape

**KTS-FL2**  
3.5mm x 10m  
Finish Line Knifeless Tape  
(Trial Size)



#### 3M™ Products

3M Products can **ONLY** be distributed to customers in the United States and US Territories.

### Bernzomatic® High Heat Torch Nozzle

The optimized swirl flame burns hot and efficiently for maximum heat output. The auto start/stop ignition lights and extinguishes the flame with the push of a button. Run-lock button keeps the torch lit for continuous use. Propane not included.



**TS4000T**  
High Heat Torch Nozzle



Tools

### 4" Vinyl Removal Wheel

Rubber decal eraser wheel is designed to remove decals, pinstripes or bumper stickers from cars, trucks, boats and RVs.

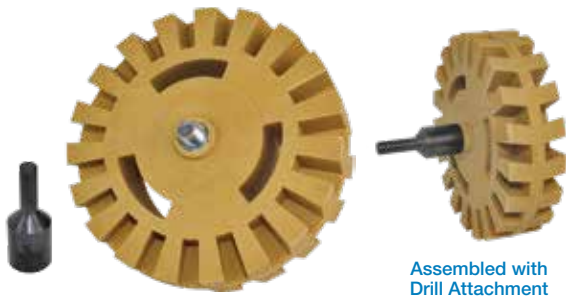

VRW-4

Assembled with Drill Attachment







## Weldy Heat Guns

Simple. Good. Affordable. That's what you'll enjoy when you pick up a Weldy heat gun. People in more than 80 countries work with Weldy, making it the hottest tool for cost-conscious installers.



### HG 330-B Car Wrap Kit

#### W128355

Ergonomically designed and lightweight for simple use and high productivity.

#### FEATURES

- 16.4 ft long cord
- Heat protection
- Pair of air inlet covers
- Soft handle
- Balanced design

#### SPECS

- Temp Options: 662°F or 1022°F
- Length: 9.84"
- Width: 3.14"
- Height: 9.05"
- Handle Diameter: 1.77"
- Weight: 1.54 lb



### HG 530-A Car Wrap Kit

#### W128356

Premium heat gun with digital temperature control.

#### FEATURES

- Air flow control
- 16.4 ft long cord
- Heat protection
- Pair of air inlet covers
- Top mounted digital temp display
- Program five different temperature and air volume settings
- Eco mode
- Soft handle
- Balanced design

#### SPECS

- Temp Range: Variable 176°F to 1202°F
- Length: 9.84"
- Width: 3.14"
- Height: 9.05"
- Handle Diameter: 1.77"
- Weight: 1.65 lb

## Kota Pro™ Magnets

Kota Pro™ Magnets allow for convenient vinyl installation on steel without the hassle of tape. The strong hold and the soft blue protective coating make the Kota Pro Magnet a safe and effective way to register your vinyl graphics.

**KOTA<sub>PRO</sub>**



**GREAT VALUE!**



**MP110**  
1 3/4" Install Magnet with Ring



**MP120**  
1 3/4" Install Magnet with Handle



**MP130**  
2 5/8" Install Magnet with Handle



Super Strong, Soft Safety Cover



Tools

## Kota Pro™ Tool Sets

These tool sets are specific to vehicle wraps. The removal tools will assist pulling off badges and other trim components from a vehicle so you can wrap behind them. For areas that can't be removed, the tuck tools have several unique tips that help work vinyl behind trim and other unique challenges found when wrapping a vehicle.

**KOTA<sub>PRO</sub>**



**KPT101**  
4-Piece Plastic Small Emblem Removal Tool Set



**KPT102**  
7-Piece Plastic, Magnetic Tuck Tool Set with Case

## Kota Pro™ Squeegees

These value-priced tools are specifically designed with the most popular applications in mind. Choose between a soft squeegee when flexibility is needed and a firm squeegee when more pressure is required during masking or installing vinyl graphics.

**KOTA<sub>PRO</sub>**



**SQ103**  
4" Green  
Soft Squeegee

**SQ104**  
4" Black  
Firm Squeegee

**SQ101**  
4" Blue  
Firm Squeegee

**SQ105**  
6" Black  
Firm Squeegee

**SQ102**  
6" Blue  
Firm Squeegee

See page  
164 for  
Squeegee  
Tape

## Big Blade Removal Tools

Plastic razor blades are designed to help remove large pressure sensitive materials from an array of surfaces that scratch easily. They are safe, strong and reusable.

**Lidco**



**LD7105**  
Rigid Pearl  
Chemically Resistant  
Plastic Razor Blade  
Size: 3" x 4"

**Chemically  
Resistant**

**LD7104**  
Flexible Blue Indigo  
Chemically Resistant  
Plastic Razor Blade  
Size: 3" x 4"

**LD7100**  
Firm Green  
Plastic Razor Blade  
Size: 3" x 4"



Tools

## Chizzler Removal Tool

This one-size polycarbonate tool is great for removing materials or applying it in tight corners. Rolled edges scrape without marring. This low profile design has one flat side and one side slightly beveled. The center thumb spot offers extra comfort and grip.



**LD5003**  
Lightweight  
Removal Tool  
Size: 2.3125" x 3"



**Lidco Squeegees**

Tools

**LD1007**  
4" RC-4  
White  
Squeegee

**LD1009**  
4" RC-4  
Silver Nylon  
Squeegee

**LD1015**  
4" RC-4  
White Teflon  
Squeegee

**LD1020**  
12" RC-12  
White  
Squeegee

**LD1043**  
6" RC-6  
White Teflon  
Squeegee

**LD1051**  
12" RC-12  
Blue  
Squeegee

**LD1500**  
4" PAG-SSA  
Soft Spreader  
Applicator

**LD6102**  
4" Standard  
Weight Felt  
Edge Wrapped  
Squeegee

**LD6105**  
6" Standard  
Weight Felt  
Edge Wrapped  
Squeegee

**White 4" Squeegee**

RC-4" rounded corner poly-flow blend, features high-stability twin ribs for easy handling and pressure control. Medium flex and high glide.

**Silver Nylon 4" Squeegee**

RC-4" rounded corner nylon-flow blend, outlasts most other squeegees depending on application material. Low flex and high glide.

**White Teflon™ 4" Squeegee**

RC-4" rounded corner Teflon blend design. This squeegee is extremely rigid and helps eliminate cupping. Teflon is great when working with adhesives because they do not adhere to its blade.

**White 12" Squeegee**

RC-12" rounded corner poly-flow blend, features high-stability twin ribs for easy handling and pressure control. Medium flex and high glide.

**White Teflon™ 6" Squeegee**

RC-6" rounded corner Teflon blend design. This squeegee is extremely rigid and helps eliminate cupping. Teflon is great when working with adhesives because it does not adhere to its blade.

**Blue 12" Squeegee**

RC-12" rounded corner poly-flow blend, features high-stability twin ribs for easy handling and pressure control. Medium flex and high glide.

**4" Soft Applicator**

PAG-SSA rounded corner, low profile, indent style, poly-flow blend design with flat surface without reinforcing ribs. High flexibility and high glide.

**Felt Edge Wrapped Squeegees**

Rounded corners, stabilizing ribs and poly blended materials are combined with industrial grade felt creating two tools in one. Felt wrapped edge helps protect vinyl from scratches. Saves time and money by eliminating the need to wrap your squeegee or use premask.

**Assorted Squeegees**



**PSPS**  
PROSQUEEGEE  
4" Black  
Squeegee

**PSL**  
PROSQUEEGEE  
LITE  
4" Red  
Squeegee

**A013179**  
4" Blue Felt  
Squeegee

**A013185**  
4" Red  
Pro Flex  
Squeegee

**PROSQUEEGEE  
4" Squeegee**

This rigid squeegee will be sure to hold to its shape no matter what you throw at it. This 4" squeegee includes 1 wet PROBUFFER and 1 dry PROBUFFER.



"Tools for Artists, by Artists"

**PROSQUEEGEE LITE  
4" Squeegee**

The most flexible PROSERIES squeegee. This 4" squeegee is super conformable and sure to help in the most complex installs.



"Tools for Artists, by Artists"

**Avery Dennison® Blue  
4" Felt Squeegee**

Blue nylon reinforced squeegee with a blue felt edge that will not scratch or mar the surface of digital prints or specialty vinyl. The perfect tool for flat or lightly curved surfaces.



**WARNING**  
CANCER AND REPRODUCTIVE HARM  
[www.P65Warnings.ca.gov](http://www.P65Warnings.ca.gov)

**Avery Dennison® Red  
4" Pro Flex Squeegee**

A red, softer and more flexible squeegee with a felt edge that will not scratch or mar the surface of digital prints or specialty vinyl. Ideal for 3D applications, deep corrugations and curved applications like pillars or car bumpers.



**WARNING**  
CANCER AND REPRODUCTIVE HARM  
[www.P65Warnings.ca.gov](http://www.P65Warnings.ca.gov)

**3M™ Products**

3M Products can **ONLY** be distributed to customers in the United States and US Territories.

**Avery Dennison® Products**

Avery Dennison® Products can **ONLY** be distributed to customers in the United States and US Territories.

Tools

## Kota Pro™ PTFE Glass Cloth Tape and PTFE Film Tape

These tapes can be cut to size and applied to the edge of a squeegee. The tape keeps the squeegee moving smoothly over the surface of the vinyl, resisting heat and reducing the number of scratches left behind during installation. You won't choose another squeegee buffer after using these tapes!



**SG3503**  
Non-stick PTFE  
Glass Cloth Tape  
Thickness: 5.3 mil  
Size: 1" x 36 yd roll



**SG226502**  
Non-stick PTFE  
Film Tape  
Thickness: 3.7 mil  
Size: 1" x 36 yd roll



**SG226505**  
Non-stick PTFE  
Film Tape  
Thickness: 6.7 mil  
Size: 1" x 36 yd roll



Example of glass cloth tape used on squeegee to create a non-stick surface.



## Kota Pro™ Felt Squeegee Block

This applicator is ideal to use with digital print mounting or installing on glass. Designed for applying vinyl materials to avoid scratching.



**FSB01**  
Felt Squeegee Block  
Size: 4" x 2 3/4" x 1/2"



Tools

## Wet Edge Squeegee

This Teflon squeegee, with a unique microfiber edge, is ideal for wet applications. Applying water to the Wet Edge side allows the squeegee to glide over media without scratching while reducing friction.



**WES**  
4" Wet Edge  
Squeegee



## Avery Dennison® White Stiff 4" Squeegee

Avery Dennison's white squeegee with blue felt strip. It's extra stiff, very durable and fantastic on flat applications.



**A009266**  
White Stiff Squeegee



### Avery Dennison® Products

Avery Dennison® Products can **ONLY** be distributed to customers in the United States and US Territories.



## Avery Dennison® FleXtreme

The Avery Dennison® FleXtreme squeegee's unique design helps work vinyl into vehicle channels and around difficult body lines where standard squeegees can't reach. The blue FleXtreme is harder since it is designed to seamlessly apply film to narrow curves and edges. The red FleXtreme is softer which is ideal for film application in narrow, concave parts of a vehicle.

**A009365**  
FleXtreme Squeegee



**WARNING**  
CANCER AND REPRODUCTIVE HARM  
www.P65Warnings.ca.gov

## Felt Squeegee Sleeves Lidco

Reusable felt sleeves fit "industry standard" Squeegees. Simply rotating the sleeve around your squeegee provides you with multiple clean edge surfaces, minimizing dirt and static. The sleeve helps prevent nicks in the squeegee edge from damaging your vinyl.



**LD6002**  
6" Reusable Felt Squeegee Sleeve

**LD6001**  
4" Reusable Felt Squeegee Sleeve

## PROBUFFERS

PROBUFFERS are designed to help protect your wrap graphics and the vehicle from scratches that are common during installation. The wet and dry PROBUFFERS fit most standard 4" squeegees and are the perfect solution for wrap installers.

- Pre-cut adhesive backed squeegee buffers to improve installation speed and protect the vinyl at the same time
- Fits standard 4" squeegees
- Leaves little to no adhesive when removed
- Dry buffers are perfect for matte, satin and gloss applications
- Wet buffers are perfect for PPF and chrome applications

## PROSERIES

"Tools for Artists, by Artists"

**CHECK OUT PAGE 163**  
**PROSERIES Squeegees!**



**Installed Buffers**  
Squeegees not included



**PSPBP**  
Squeegee Felt PROBUFFERS  
20 Pack (10 dry, 10 wet)

## Monkey Strips

Durable, replaceable, dry application pre-cut felt buffers fit a standard 4" squeegee. These self-adhesive squeegee buffers provide a soft side that does not scratch. Monkey Strips are ideal for standard signage (walls, floors and boards) and full print wraps.



**MSTRIP**  
Squeegee Buffer  
50 Pack



Tools

## Banana Buffers

Premium, replaceable, wet application buffers that make wrapping a breeze. These pre-cut, self-adhesive buffers fit a standard 4" squeegee, providing a soft side that does not scratch. Banana Buffers are ideal for chrome, windows and tint.



**BBUFF**  
Squeegee Buffer  
10 Pack





## Avery Dennison® Application Tool Belt

Keep all your tools in this specially-designed waist belt. Designed by professional applicators.



**WARNING**  
CANCER AND REPRODUCTIVE HARM  
[www.P65Warnings.ca.gov](http://www.P65Warnings.ca.gov)

### Avery Dennison® Products

Avery Dennison® Products can **ONLY** be distributed to customers in the United States and US Territories.

**A013182**

Avery Dennison®  
Application Tool Belt



## Avery Dennison® Magnets

Avery Dennison® magnets are a great way to hold and position graphics on a metal surface. These magnets replace the need for application tape.

**A013184**

1 11/16" Super Strong  
Apply Magnets - 2 Pack



**WARNING**  
CANCER AND REPRODUCTIVE HARM  
[www.P65Warnings.ca.gov](http://www.P65Warnings.ca.gov)

### Avery Dennison® Products

Avery Dennison® Products can **ONLY** be distributed to customers in the United States and US Territories.





**NEW** **PROBELT**

Versatile nylon belt, lined with Velcro. Fits waist sizes 32" - 48". Belt comes with one sliding, Paint is Dead, branded magnetic grip. Magnetic nylon bag can be detached and placed on any metal surface. Tool bag has opening for Airtag device as well as multiple storage areas for tools. Ships in branded PROSERIES box.



**PIDPROBELT**  
Probelt Wrap Tool Belt  
Fits waist sizes 32" to 48"

**PROSERIES**

*"Tools for Artists, by Artists"*

Tools

**NEW** **PROFINISHER Wrap Finishing Tools**

PROFINISHER is a set of 2 finishers. Each is ergonomically designed to rest in your hand in a natural position. The black, hard finisher is designed to gently move and gap trim and rubber molding in tight areas and corners. The red, soft finisher is designed to tuck and finish films into tight areas and corners. Ships in branded PROSERIES box.



**PSPF**  
Profinisher Wrap  
Finishing Tools

**PROSERIES**

*"Tools for Artists, by Artists"*



## PROFORM

Designed and built to allow you to wrap any protrusion with ease. Keeps tension on all sides, allowing you to form vinyl without fumbling from all angles. This works great for wrapping mirrors, handles, antennas or any protruding surface.

## PROSERIES



PIDPROFORMPVC



"Tools for Artists, by Artists"

## PROGLOVE HD™ Wrap Gloves

Improve your install time with the latest in the PROGLOVE Series. The HD glove is constructed with the PROSLIDE thread coating, giving it the lowest coefficient of friction of any wrap glove.

## PROSERIES

"Tools for Artists, by Artists"



### PROGLOVE HD

**PIDPGHDM**  
White **PROGLOVE HD**  
Wrap Gloves  
Size: Medium

**PIDPGHDL**  
White **PROGLOVE HD**  
Wrap Gloves  
Size: Large



**PSPGHDB-M**  
Black **PROGLOVE HD**  
Wrap Gloves  
Size: Medium

**PSPGHDB-L**  
Black **PROGLOVE HD**  
Wrap Gloves  
Size: Large

## Heavy Duty Wall-Mount Rack

Square tube 5/16" heavy duty steel design with silver vein (black) powder coat finish.

- Holds 20 Vinyl Rolls
- Holds Up To 30" Rolls
- Designed for 3" Cores
- Great Space Saver
- Keeps Vinyl Off the Floor
- Heavy Duty Construction
- Mounting Hardware Not Included



**WR20**

Heavy Duty Wall-Mount  
Material Rack  
26" H x 32" W x 14" D



Wall rack has 3 mounting holes on the top and bottom for a total of 6 holes. Mounting hardware is not included.

## Heavy Duty Mobile Floor Rack

Square tube heavy duty steel design with silver vein (black) finish.

- Neatly Holds 16, 3" Core Rolls
- Great Space Saver
- Keeps Vinyl Off the Floor
- Heavy Duty Nylon Casters
- Locking Wheels
- Holds up to 1,000 lbs.
- Heavy Duty Construction



**MR16R**

Heavy Duty Mobile  
Floor Material Rack  
17" H x 24 1/2" W x 25" D



## Heavy Duty Freestanding Floor Rack

Square tube 5/16" heavy duty steel design with silver vein (black) powder coat finish.

- Holds 44, 12" to 30" Vinyl Rolls
- Designed for 3" Cores
- Saves Material from Damage
- Great Space Organizer
- Heavy Duty Construction

**FR44**

Heavy Duty Freestanding  
Floor Rack  
74 1/4" H x 32" W x 19" D





## Auto Skins Wrap Installation Tools

The Bumper Pole makes it easy to install bumpers by keeping the vinyl tight like glass. Use your free hand to assist with tension as you lay the panel around the corners. Connect the Wrap Hook into the latches of hoods, doors and small trunks to hold them ajar while installing a vehicle wrap.



**BPOLE40**  
The Bumper Pole, 40"

**HKLK7**  
The Wrap Hook, 7"



## Auto Skins Wall Racks

Organize your shop and increase floor space with Auto Skins wall-mounted vinyl racks. These high-quality racks are laser cut and designed to store rolls with a 3" core. Two styles available: 4.5" for 25 yd partial rolls and 6.5" for 50 yd partial rolls. Includes two metal mounts. Mounting hardware and dowel rods not included.



**ASR45**  
25 yd Wall Rack

**ASR65**  
50 yd Wall Rack

Tools

## Kota Pro™ Media Clips

Ideal for keeping vinyl and print media neatly wound. Durable plastic design is easy to use and does not leave marks on your material. Alleviates having to use tape that needs to be replaced or that damages your materials.



**SMC2**  
20 Pack,  
Large Media Clip  
Fits Standard  
50 Yard Rolls

**SMC1**  
20 Pack,  
Small Media Clip  
Fits Standard  
10 Yard Rolls



Tools

## Z-Straps

Z-Straps are a great way to keep your vinyl clean and neatly stored. These adjustable and reusable high quality die cut hook and loop straps are specifically designed for the sign industry. Z-Straps provide an exceptional solution superior to tape, which can leave residue and cause damage to your valuable inventory.



**ZS10BLK**  
10 Pack Black Die Cut  
Hook & Loop Straps  
Size: 1/2" x 23"



**ZS10YLW**  
10 Pack Yellow Die Cut  
Hook & Loop Straps  
Size: 1/2" x 23"



**ZS10BLU**  
10 Pack Blue Die Cut  
Hook & Loop Straps  
Size: 1/2" x 23"



**ZS10RED**  
10 Pack Red Die Cut  
Hook & Loop Straps  
Size: 1/2" x 23"

Z-Straps are 23" in length, allowing them to wrap completely around a standard roll of vinyl.





## Rapid Prep - Surface Prep

Rapid Prep is a water based solvent that is a safe and super effective deep cleaner, ideal for surface prep. It is designed to work in one minute to remove wax, silicone, grease, oil and other surface build-ups. For best vinyl adhesion results, apply Rapid Prep to substrate before application.



**RP-51285-1**  
Rapid Prep  
Size: 1 Gallon

**RP-50325-5**  
Rapid Prep  
with Spray Nozzle  
Size: 32 oz.

32 oz.  
**BOTTLES  
COME WITH  
SPRAY  
NOZZLE**

## Rapid Tac Application Fluid

Rapid Tac allows installers more control over their applications; making it easier to apply vinyl without wrinkles or bubbles. This application fluid also cleans the vinyl without leaving residue, ensuring a contaminant free installation.

**WARNING**  
CANCER AND REPRODUCTIVE HARM  
[www.P65Warnings.ca.gov](http://www.P65Warnings.ca.gov)



**RT-11281-5**  
Rapid Tac  
Size: 1 Gallon

**RT-10321-9**  
Rapid Tac  
with Spray Nozzle  
Size: 32 oz.

## Rapid Tac II - Application Fluid

Rapid Tac II was designed for "Premium Cast" films and promotes faster bonding than the Original Rapid Tac product. This application fluid is ideal for cold weather and glass applications. In warmer conditions always pretest, because Rapid Tac II may bond too quickly with premium cast films.

**WARNING**  
CANCER AND REPRODUCTIVE HARM  
[www.P65Warnings.ca.gov](http://www.P65Warnings.ca.gov)



**RT2-71287-9**  
Rapid Tac II  
Size: 1 Gallon

**RT2-70327-3**  
Rapid Tac II  
with Spray Nozzle  
Size: 32 oz.

## Rapid Remover Adhesive Remover

Rapid Remover is a water based solvent that quickly and safely lifts most adhesives in 30 to 60 seconds without damage to most painted or bare metal surfaces. Simply spray it on, wait 30 to 60 seconds, and easily wipe away residue with a plastic squeegee and paper towel with no mess.

Rapid Remover can only be shipped by ground in the continental U.S.

**WARNING**  
CANCER AND REPRODUCTIVE HARM  
[www.P65Warnings.ca.gov](http://www.P65Warnings.ca.gov)



**RR-31283-3**  
Rapid Remover  
Size: 1 Gallon

**RR-30323-7**  
Rapid Remover  
with Spray Nozzle  
Size: 32 oz.

Tools





## Auto Sauce

### Ceramic Wrap Sauce Kit

Protect your vehicle wrap with this ceramic coating specifically engineered for vinyl wraps. The coating will bond well to vinyl, provide scratch resistance and make it easier and safer to clean the vehicle.

**CWS50**

- Ceramic Wrap Sauce Kit
- 1 50 ml. Ceramic Wrap Sauce
- 1 8 oz. Ceramic Booster
- 1 Applicator



Ceramic Wrap Sauce Kit can only be shipped by ground in the continental U.S.



### Wrap Booster

Apply this specially formulated spray between washes to extend the life of the ceramic coating and give your wrap a fresh vibrant look.

**CSS16**

- 16 oz. Ceramic Sauce Booster

### Spray Sauce

Use this spray solution for quick cleaning when you don't have time to do a full wash. Great for removing finger prints, water spots or a light coat of dust.

**MAS16**

- 16 oz. Matte Mango Spray Sauce for Matte & Satin Wraps



### Bubble Wash

When you need to give the vehicle a good old-fashioned wash, pour a little of this in a bucket, add water and scrub. Wash by hand, DO NOT use with a pressure washer.

**MMW16**

- 16 oz. Matte Mango Bubble Wash for Matte & Satin Wraps



**SWS16**

- 16 oz. Sweet Wrap Spray Sauce for Gloss Wraps



**SRW16**

- 16 oz. Sweet Wrap Bubble Wash for Gloss Wraps



## Auto Sauce Accessories

Use these items when applying or maintaining your ceramic coating.



**BRA**  
Blueberry Applicator  
The official applicator for applying the ceramic coating solution.



**BLM2**  
Blueberry Microfiber 2 pk  
Recommended when buffing out the ceramic coating for a superior shine and finish.



**APS2**  
Apple Spice Microfiber 2 pk  
Use this when applying the Ceramic Sauce Booster, Spray Sauce or even when washing your vehicle with the Bubble Wash.



**AUTOSAUCEGUIDE**   
Auto Sauce Wrap Care Guide Brochure



## Avery Dennison® Wrap Care Products

The Avery Dennison Supreme Wrap™ Care range includes a Cleaner, Power Cleaner and Sealant. These professional grade products are simple for anyone to use. They help matte, satin and gloss vehicle wraps cope with all the challenges of the road after leaving the workshop.



**A013220**  
32 oz. Supreme Care Cleaner



**A013221**  
32 oz. Supreme Power Cleaner



**A013219**  
32 oz. Supreme Care Sealant

**WARNING**  
CANCER AND REPRODUCTIVE HARM  
www.P65Warnings.ca.gov

**Avery Dennison® Products**  
Avery Dennison® Products can **ONLY** be distributed to customers in the United States and US Territories.

## Tesa® High Bond Mounting Tapes



**ACX Plus High Adhesion**  
Black Acrylic Foam Tape  
High bond tape designed for "hard-to-bond" surfaces including powder-coated material. Use indoors or outdoors.

**7065-1**

Thickness: 47 mil  
Size: 1/2" x 27yd

**7065-2**

Thickness: 47 mil  
Size: 3/4" x 27yd

**7065-3**

Thickness: 47 mil  
Size: 1" x 27yd



**ACX Plus High Transparency**  
Clear Acrylic Foam Tape  
Heavy duty, transparent tape known for its bonding power, stress dissipation plus temperature & weather resistance. Use indoors or outdoors.

**7055-1**

Thickness: 40 mil  
Size: 1/2" x 27yd

**7055-2**

Thickness: 40 mil  
Size: 3/4" x 27yd

**7055-3**

Thickness: 40 mil  
Size: 1" x 27yd



**Polypropylene Tape**  
Black Foam Tape  
Excellent long-term adhesive with less "gap" thanks to a smaller thickness. High ultimate adhesion. Use indoors or outdoors.

**62932-1**

Thickness: 22 mil  
Size: 1/2" x 55yd

**62932-2**

Thickness: 22 mil  
Size: 3/4" x 55yd

**62932-3**

Thickness: 22 mil  
Size: 1" x 55yd

Mounting Tape

## Double-Faced Tapes



### Tesa® Gold-Line Premium Tape

White Tape  
Thickness: 9 mil

Size	Part No.	Case Qty.
1/4" x 36 yd.	H117	6
3/8" x 36 yd.	H119	6
1/2" x 36 yd.	H120	6
5/8" x 36 yd.	H124	6
3/4" x 36 yd.	H121	6
1" x 36 yd.	H122	6
1 1/2" x 36 yd.	H125	6
2" x 36 yd.	H126	6



### Gold Standard Tape

White Tape  
Thickness: 9 mil

Size	Part No.	Case Qty.
1/2" x 36 yd.	H142	6
3/4" x 36 yd.	H144	6
1" x 36 yd.	H146	6

**TAPE3** - Free Sample (limit 1 per customer)



## Double-Faced Tapes



### Hand Tearable Tape

White Tape

Thickness: 6 mil

Size	Part No.	Case Qty.
1/2" x 36 yd.	<b>H181</b>	6
3/4" x 36 yd.	<b>H182</b>	6
1" x 36 yd.	<b>H183</b>	6



### Engravers Tape

Clear Tape

Thickness: 3 mil

Size	Part No.	Case Qty.
1/2" x 36 yd.	<b>H161</b>	6
3/4" x 36 yd.	<b>H162</b>	6
1" x 36 yd.	<b>H163</b>	6

**WARNING**  
 CANCER AND REPRODUCTIVE HARM  
[www.P65Warnings.ca.gov](http://www.P65Warnings.ca.gov)



### Foam Tape

White Foam Tape

Thickness: 1/32"

Size	Part No.	Case Qty.
1/2" x 72 yd.	<b>H170</b>	6
3/4" x 72 yd.	<b>H172</b>	6
1" x 72 yd.	<b>H174</b>	6

Thickness: 1/16"

Size	Part No.	Case Qty.
1/2" x 36 yd.	<b>H175</b>	6
3/4" x 36 yd.	<b>H176</b>	6
1" x 36 yd.	<b>H177</b>	6

**WARNING**  
 CANCER AND REPRODUCTIVE HARM  
[www.P65Warnings.ca.gov](http://www.P65Warnings.ca.gov)



H102 Shown

### White Tape Disks

Size	Description	Part No.	Case Qty.
1 3/4" Diameter x 500/Roll	Gold Standard Tape Disks with Tabs	<b>H102</b>	1
1 3/4" Diameter x 500/Roll	1/16" Foam Tape Disks with Tabs	<b>H103*</b>	1
1 3/4" Diameter x 500/Roll	1/32" Foam Tape Disks with Tabs	<b>H108*</b>	1

\***WARNING**  
 CANCER AND REPRODUCTIVE HARM  
[www.P65Warnings.ca.gov](http://www.P65Warnings.ca.gov)



# Stand-Offs & Frames

*if you're looking for:*

PLASTICADE SIGN FRAMES

STAND-OFFS

ADA SIGNS

PRONTO CHANGEABLE COPY

PRONTO ACCESSORIES

DESK HOLDERS & WALL BRACKETS

CORRUGATED PLASTIC AND H STAKES

CAST ALUMINUM PLAQUES

GRAPHTEC PLOTTERS





## PLASTICADE® Sign Frames

These all plastic, heavy-duty stands have hinges that lock in the open position to prevent over-extending and have molded handles for easy portability.

### Signicade

- Attach poster material, self-adhesive vinyl or other sign material directly to the surface
- Indented sign area helps protect the sign face
- Dry sand can be added for ballast – 10 lbs. recommended



**PC130-BK-1PKF**  
Black  
Sign Face Size: 24" x 36"



**PC130-W-1PKF**  
White  
Sign Face Size: 24" x 36"

**DISPLAYS TWO SIGNS**  
1 ON EACH SIDE



See pages 92-93 for Poster Material!

**NO** Rust Discoloration Maintenance

### Signicade Deluxe

- Change signs in seconds with patented Quick-Change™ feature
- Stay Tabs™ ensure sign stays securely in place
- Use rigid material with a thickness of 3/16" or less
- Dry sand can be added for ballast – 10 lbs. recommended

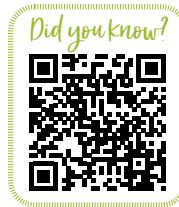

**PC140-W-1PKF**  
White  
Sign Face Size: 24" x 36"

**PC140-BK-1PKF**  
Black  
Sign Face Size: 24" x 36"



**DISPLAYS TWO SIGNS**  
1 ON EACH SIDE



## PLASTICAIDE® Sign Frames

Change signs in seconds with the patented Quick-Change™ feature. Use corrugated plastic or other rigid material up to 3/16" thick and with the Stay Tabs™ your sign will stay securely in place.

### Wind Sign II & Wind Sign Deluxe with Quick Change

- Coil Springs resist wind gusts and return sign to upright position
- Wide, stable base with factory-installed wheels, tilt back and roll
- Features a large fill hole to add dry sand for ballast
- Dry sand can be added for ballast – up to 115 lbs. recommended

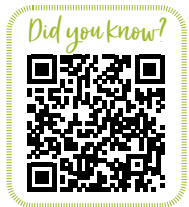

**PC1833**  
Wind Sign Deluxe  
Gray  
Sign Face Size: 28" x 44"

**PC1822**  
Wind Sign II  
Gray  
Sign Face Size: 24" x 36"

**NO** Rust  
Discoloration  
Maintenance



### Signicade MDX

- Lightweight and easy to move
- Dry sand can be added for ballast – 4 lbs. recommended



**PC141BK**  
Black  
Sign Face Size: 18" x 24"

**PC141W**  
White  
Sign Face Size: 18" x 24"

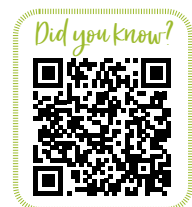

Sign Frames



## PLASTICADE® Sign Frames

- Change signs in seconds with the patented Quick-Change™ feature
- Stay Tabs™ ensures sign stays securely in place
- Use rigid material with a thickness of 3/16" or less
- Textured feet help secure the frame on smooth surfaces
- Grabber Hinges hold a sign rider and prevent the frame from opening too far
- Dry sand can be added for ballast – 6 lbs. recommended

### Simpo Sign II

- Medium-sized, versatile, frame



### PC1225BK

Black  
Sign Face Size: 22" x 28"



### PC1225W

White  
Sign Face Size: 22" x 28"

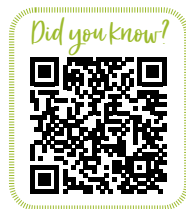

**NO** Rust  
Discoloration  
Maintenance

### Simpo Square 24

- An economical A-frame for temporary signs
- Use rigid material with a thickness of 3/16" or less

### PC1240W

White  
Sign Face Size: 24" x 24"



### PC1240BK

Black  
Sign Face Size: 24" x 24"







## PLASTICADE® Sign Frames

### Roll-A-Post™

- Thick-walled plastic, sand-fillable bases won't chip, crack or crumble
- Square 1.75" plastic tubes with reinforcing internal crossbars
- More durable and stable than round posts
- Sturdy, factory-installed wheels make bases easy to move
- Posts include cap and pre-drilled holes for multiple sign sizes
- Sign-mounting hardware is included
- Withstands strong winds without tipping over when bases are filled
- Dry sand up to 125 lbs. recommended
- DO NOT FILL WITH WATER ONLY

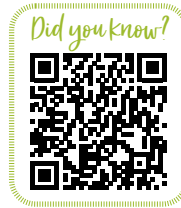

Sign Not Included



Sign Frames

### Roll-A-Post

Base Size	Post Length	Description	Part No.
18" x 12"	60"	Black Base/Black Pole	PC1860BK
18" x 12"	60"	Black Base/White Pole	PC1860W
24" x 16.5"	60"	Black Base/Black Pole	PC2460BK
24" x 16.5"	60"	Black Base/White Pole	PC2460W
24" x 16.5"	72"	Black Base/Black Pole	PC2472BK
24" x 16.5"	72"	Black Base/White Pole	PC2472W

Replacement bases & poles available. Call for details.



## PLASTICADE® Sign Frames

### Rubber Base

- Square 1.75" plastic post with a 30 or 60 lb. rubber base to withstand strong winds without tipping over
- Durable, recycled rubber bases can be stacked to increase weight
- Resistant to weather, oil, salt, moisture and UV light
- Bases won't warp, chip, crack or crumble
- Molded-in hand grips make moving bases easier. Durable wheels are optional
- Sign-mounting hardware is included

Sign Not Included



### Rubber Base

Base Size	Post Length	Base Weight	Description	Part No.
18.5" x 18.5"	60"	30 lb.	Black Base/Black Pole	PC8360BK
18.5" x 18.5"	60"	30 lb.	Black Base/White Pole	PC8360W
18.5" x 22.85"	60"	30 lb.	Black Base with Wheels/Black Pole	PC8360BKWHL
18.5" x 22.85"	60"	30 lb.	Black Base with Wheels/White Pole	PC8360WWHL
18.5" x 18.5"	60"	60 lb.	Black Base/Black Pole	PC8660BK
18.5" x 18.5"	60"	60 lb.	Black Base/White Pole	PC8660W
18.5" x 22.85"	60"	60 lb.	Black Base with Wheels/Black Pole	PC8660BKWHL
18.5" x 22.85"	60"	60 lb.	Black Base with Wheels/White Pole	PC8660WWHL
18.5" x 18.5"	72"	60 lb.	Black Base/Black Pole	PC8672BK
18.5" x 18.5"	72"	60 lb.	Black Base/White Pole	PC8672W
18.5" x 22.85"	72"	60 lb.	Black Base with Wheels/Black Pole	PC8672BKWHL
18.5" x 22.85"	72"	60 lb.	Black Base with Wheels/White Pole	PC8672WWHL

Additional bases & replacement poles available. Call for details.

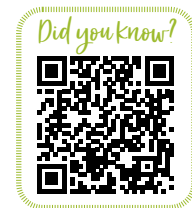



## PLASTICADE® Sign Frames

### Rock-It™

- Square 1.75" plastic signpost with a durable, thick-walled plastic sand-fillable base
- Rock it back and roll it easily with durable plastic wheels
- Thick-walled plastic bases won't chip, crack or crumble
- Conveniently placed large fill hole and drain hole
- Withstands strong winds without tipping over when filled with dry sand
- Sign-mounting hardware is included
- Dry sand up to 125 lbs. recommended
- DO NOT FILL WITH WATER ONLY

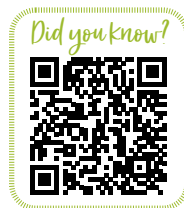

Sign Not Included

### Rock It

Base Size	Post Length	Description	Part No.
18" x 19.5"	60"	Black Base/Black Pole	PCRB1860BK
18" x 19.5"	60"	Black Base/White Pole	PCRB1860W
24" x 25.5"	60"	Black Base/Black Pole	PCRB2460BK
24" x 25.5"	60"	Black Base/White Pole	PCRB2460W
24" x 25.5"	72"	Black Base/Black Pole	PCRB2472BK
24" x 25.5"	72"	Black Base/White Pole	PCRB2472W

Replacement bases & poles available. Call for details.

Sign Frames



## Kota Pro™ Solid Color LED Stand-Offs

Choose from Red, Green, Blue or White to illuminate your sign.

- Suitable for indoor use only
- Includes drywall screws and anchors for installation
- Sold in packs of 4 only
- Includes Power Supply
- For best results use cast acrylic, see page 186



Diameter	Barrel Length	Blue LED Part #	Red LED Part #	White LED Part #	Green LED Part #	Case Qty.
1"	1"	<b>STFLED2525BL</b>	<b>STFLED2525RD</b>	<b>STFLED2525WT</b>	<b>STFLED2525GN</b>	4

Prices are per piece. Sold in full cases of 4 only.



Diameter	Barrel Length	Blue LED Part #	Red LED Part #	White LED Part #	Green LED Part #	Case Qty.
1 1/4"	1"	<b>STFLED3225BL</b>	<b>STFLED3225RD</b>	<b>STFLED3225WT</b>	<b>STFLED3225GN</b>	4

Prices are per piece. Sold in full cases of 4 only.



STFLED2525BL or  
STFLED3225BL Illuminated

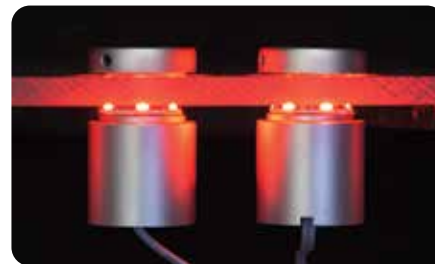

STFLED2525RD or  
STFLED3225RD Illuminated

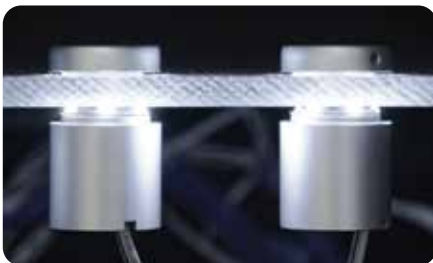

STFLED2525WT or  
STFLED3225WT Illuminated

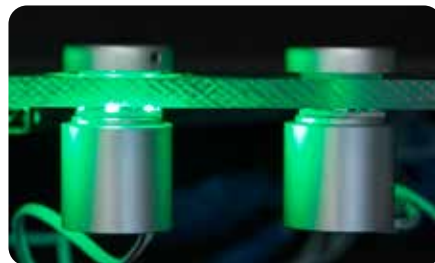

STFLED2525GN or  
STFLED3225GN Illuminated

## Kota Pro™ RGB LED Color Changing Stand-Offs

Set the color and motion of the LED with an easy to use remote control. Choose from a variety of shades and colors to best match your application.

- Suitable for indoor use only
- Includes drywall screws and anchors for installation
- Sold in packs of 4 only
- Includes Power Supply

**KOTA<sub>PRO</sub>**



Diameter	Barrel Length	Red, Green & Blue LED Part #	Case Qty.
1 1/4"	1"	<b>STFLED3525RGB</b>	4

Prices are per piece. Sold in full cases of 4 only.



**STFRGBPWR1**  
Additional Power Supply for STFLED3525RGB

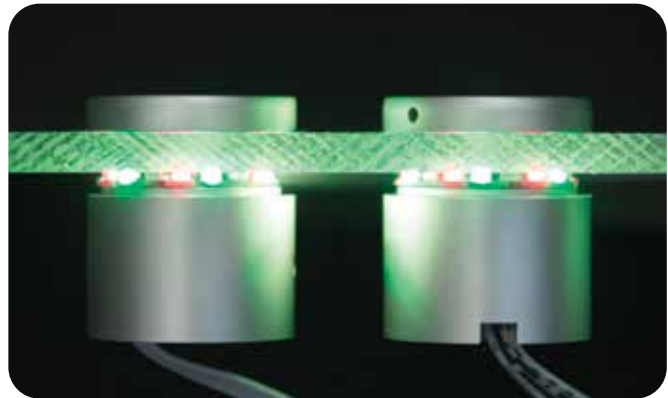

STFLED3525RGB Illuminated

Stand-Offs



**STFLED1**  
Stand-Offs Display  
Includes 1 each of Kota Pro LED & RGB LED Changing Stand-Offs & Screw Caps on Laserable Leatherette background.  
Size: 12" x 18"

## Kota Pro™ Tamper-Resistant, Low Profile Aluminum Stand-offs

- Suitable for indoor applications
- Includes drywall screws and anchors for installation
- Sold in packs of 4 only
- Required holes for signage substrates: 0.40"

### Square

Color	Size	Barrel Length	Part #	Case Qty.
Black	.63" x .63"	1"	<b>STF0711BK</b>	4
Satin Gold	.63" x .63"	1"	<b>STF0711SG</b>	4
Satin Silver	.63" x .63"	1"	<b>STF0711ST</b>	4



Prices are per piece.  
Sold in full cases of 4 only.

**KOTA<sub>PRO</sub>**



Stand-Offs

### Round

Color	Diameter	Barrel Length	Part #	Case Qty.
Black	.51"	.83"	<b>STF0751BK</b>	4
Satin Gold	.51"	.83"	<b>STF0751SG</b>	4
Satin Silver	.51"	.83"	<b>STF0751ST</b>	4
Black	.75"	1"	<b>STF0752BK</b>	4
Satin Gold	.75"	1"	<b>STF0752SG</b>	4
Satin Silver	.75"	1"	<b>STF0752ST</b>	4



Prices are per piece.  
Sold in full cases of 4 only.

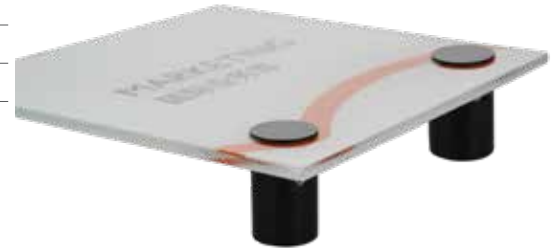

## Kota Pro™ Aluminum Cap Stand-offs

Elevate the look of flush-mounted signs. Use replacement screws to mount extra caps left over after assembly of multi-layer stand-offs.

- Suitable for indoor applications
- Includes specialty drywall screws, anchors and washers for installation
- Sold in packs of 4 only
- Required holes for signage substrate: 0.1635"

Prices are per piece.  
Sold in full cases of 4 only.

Color	Diameter	Part #	Case Qty.
Black	.63"	<b>STF0511BK</b>	4
Bright Silver	.63"	<b>STF0511NA</b>	4
Satin Gold	.63"	<b>STF0511SG</b>	4
Satin Silver	.63"	<b>STF0511ST</b>	4
Black	.87"	<b>STF0512BK</b>	4
Bright Silver	.87"	<b>STF0512NA</b>	4
Satin Gold	.87"	<b>STF0512SG</b>	4
Satin Silver	.87"	<b>STF0512ST</b>	4



## Replacement Screw for Cap Stand-offs



Part #  
**CA1622SCREW**



## Kota Pro™ Aluminum Multi-Layer Stand-offs

Create unique, eye-catching signs and displays with interchangeable stand-offs of varying lengths.

- Suitable for indoor applications
- Includes drywall screws, anchors and washers for installation
- Sold in packs of 4 only
- Required holes for signage substrate: see illustration below

**KOTA**PRO™



Prices are per piece.  
Sold in full cases of 4 only.



Color	Diameter	Barrel Length	Part #	Case Qty.
Black	.63"	.75"	STF0611BK	4
Bright Silver	.63"	.75"	STF0611NA	4
Satin Gold	.63"	.75"	STF0611SG	4
Satin Silver	.63"	.75"	STF0611ST	4
Black	.63"	.98"	STF0612BK	4
Bright Silver	.63"	.98"	STF0612NA	4
Satin Gold	.63"	.98"	STF0612SG	4
Satin Silver	.63"	.98"	STF0612ST	4
Black	.63"	1.96"	STF0613BK	4
Bright Silver	.63"	1.96"	STF0613NA	4
Satin Gold	.63"	1.96"	STF0613SG	4
Satin Silver	.63"	1.96"	STF0613ST	4
Black	.87"	.98"	STF0621BK	4
Bright Silver	.87"	.98"	STF0621NA	4
Satin Gold	.87"	.98"	STF0621SG	4
Satin Silver	.87"	.98"	STF0621ST	4
Black	.87"	2"	STF0622BK	4
Bright Silver	.87"	2"	STF0622NA	4
Satin Gold	.87"	2"	STF0622SG	4
Satin Silver	.87"	2"	STF0622ST	4

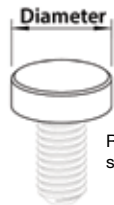

Required holes for signage substrate: 0.33" for barrel thread

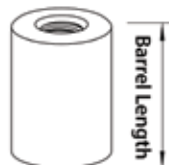

Required holes for backing substrate or wall: 0.15" for screw



Stand-Offs

## Kota Pro™ Stand-off Hole Locator

Completely attach the stand-offs to the substrate. Then insert the plastic locator into the bottom of each barrel. Align the sign against the wall in the desired location. Using a firm hand, gently press each stand-off into the wall while maintaining the sign's proper alignment. Next, set the sign aside and pre-drill holes where the indentations were left. Remove the plastic locator and install all stand-offs correctly.

- Suitable for indoor drywall applications.
- Sold in packs of 4 only
- Only suitable for stand-offs mounted with a traditional .123" diameter screw.



Color	Diameter	Part #	Case Qty.
White	.60"	SL-1510-WT	4
White	.83"	SL-2110-WT	4

Prices are per piece.  
Sold in full cases of 4 only.

Stand-Offs

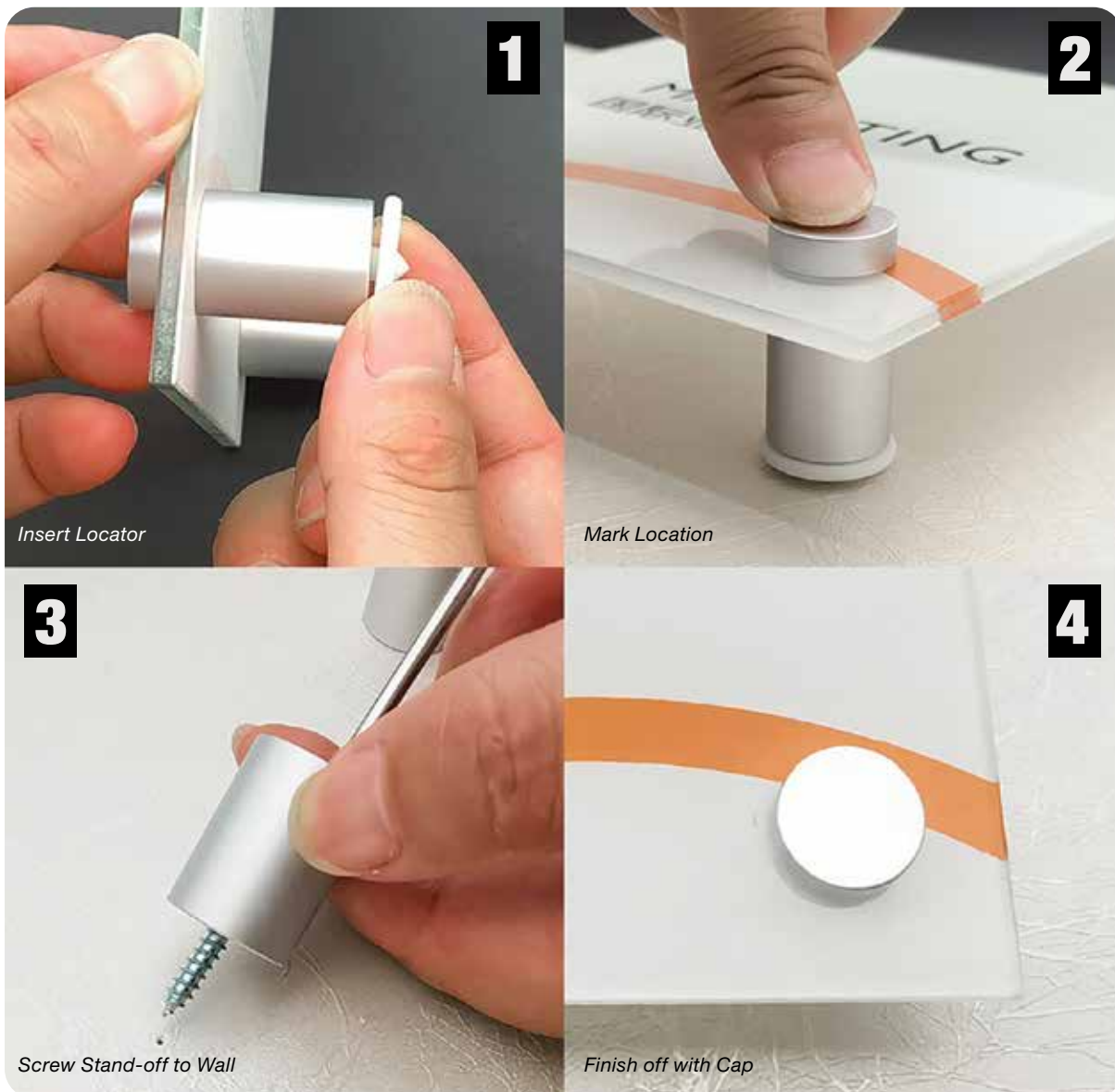

## Kota Pro™ Stainless Steel Tamper-proof Screws

- Suitable for indoor and outdoor applications
- Light Duty anti-theft torx screws and washers included
- 1 torx driver included
- Required hole for substrate: 0.125"

Color	Part #	Case Qty.
Silver	<b>SS-FH15-NA</b>	4

Prices are per piece.  
Sold in full cases of 4 only.

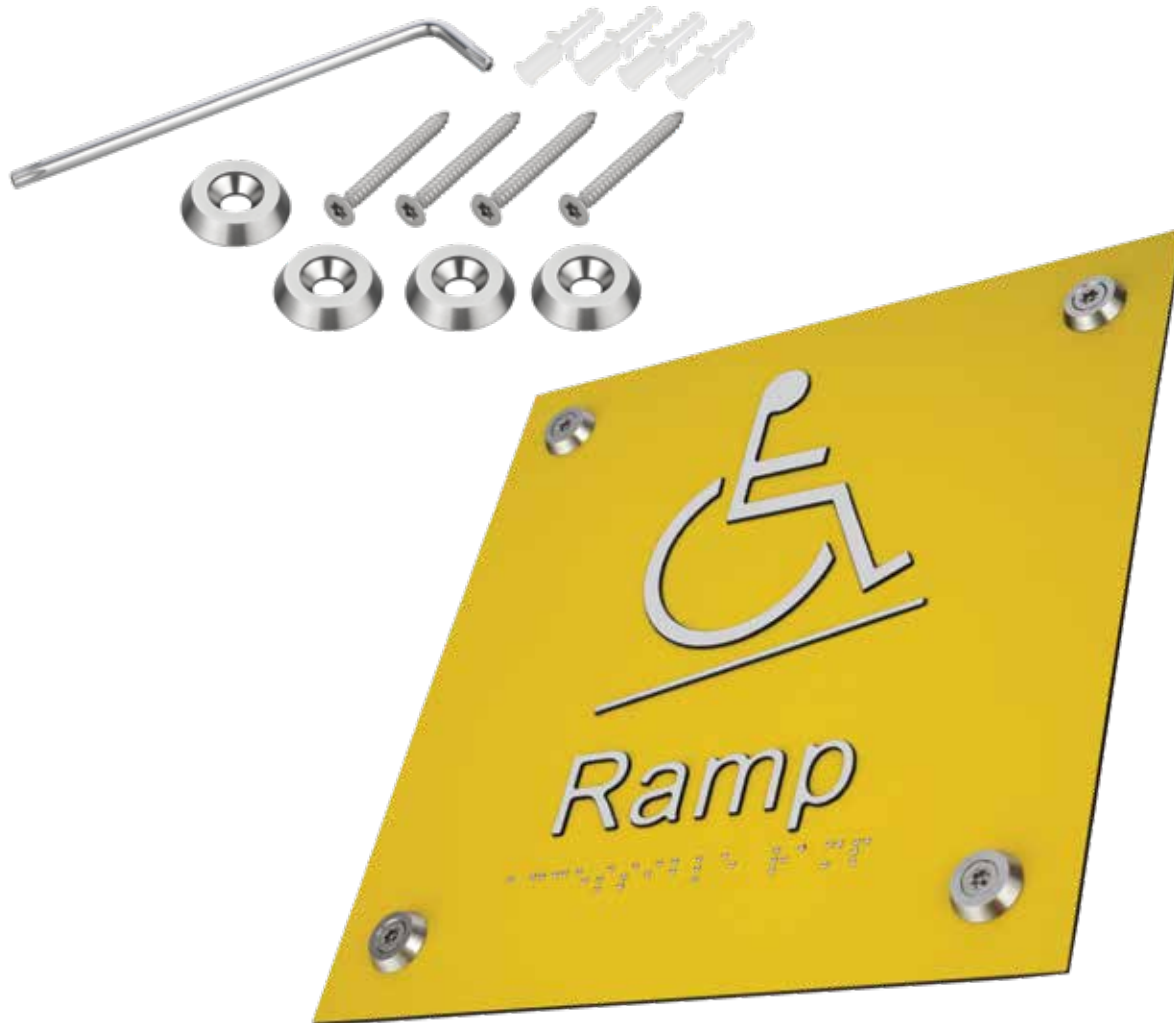



## Kota Pro™ Aluminum Stand-Offs

### Aluminum Stand-Offs:

- Suitable for indoor applications
- Include drywall screws and anchors for installation
- Sold in packs of 4 only
- Required holes in signage substrate:  
STF011XXX & STF012XXX: .31"  
STF013XXX & SFT014XXX: .39"



**KOTA<sub>PRO</sub>**



Stand-Offs



Diameter	Barrel Length	Satin Silver Part #	Case Qty.
.51"	.51"	<b>STF0111ST</b>	4
.51"	.75"	<b>STF0112ST</b>	4
.51"	.98"	<b>STF0113ST</b>	4

Diameter	Barrel Length	Satin Silver Part #	Case Qty.
.59"	.59"	<b>STF0121ST</b>	4
.59"	.78"	<b>STF0122ST</b>	4
.59"	.98"	<b>STF0123ST</b>	4

Diameter	Barrel Length	Satin Silver Part #	Case Qty.
.75"	.75"	<b>STF0132ST</b>	4
.75"	.98"	<b>STF0133ST</b>	4

Diameter	Barrel Length	Satin Silver Part #	Case Qty.
.98"	.75"	<b>STF0142ST</b>	4
.98"	.98"	<b>STF0143ST</b>	4

Prices are per piece.  
Sold in full cases of 4 only.

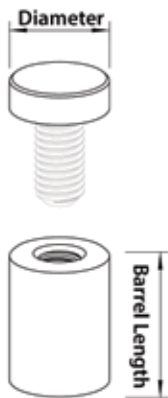

Diameter	Barrel Length	Polished Chrome Part #	Case Qty.
.51"	.51"	<b>STF0111CP</b>	4
.51"	.75"	<b>STF0112CP</b>	4
.51"	.98"	<b>STF0113CP</b>	4

Diameter	Barrel Length	Polished Chrome Part #	Case Qty.
.59"	.59"	<b>STF0121CP</b>	4
.59"	.78"	<b>STF0122CP</b>	4
.59"	.98"	<b>STF0123CP</b>	4

Diameter	Barrel Length	Polished Chrome Part #	Case Qty.
.75"	.75"	<b>STF0132CP</b>	4
.75"	.98"	<b>STF0133CP</b>	4

Diameter	Barrel Length	Polished Chrome Part #	Case Qty.
.98"	.75"	<b>STF0142CP</b>	4
.98"	.98"	<b>STF0143CP</b>	4

## Kota Pro™ Satin Gold Aluminum Stand-Offs

### Aluminum Stand-Offs:

- Suitable for indoor applications
- Includes drywall screws and anchors for installation
- Sold in packs of 4 only
- Required holes in signage substrate:  
 STF011XXX & STF012XXX: .31"  
 STF013XXX & SFT014XXX: .39"



Diameter	Barrel Length	Satin Gold Part #	Case Qty.
.51"	.51"	<b>STF0111SG</b>	4
.51"	.75"	<b>STF0112SG</b>	4
.51"	.98"	<b>STF0113SG</b>	4



Diameter	Barrel Length	Satin Gold Part #	Case Qty.
.59"	.59"	<b>STF0121SG</b>	4
.59"	.78"	<b>STF0122SG</b>	4
.59"	.98"	<b>STF0123SG</b>	4



Diameter	Barrel Length	Satin Gold Part #	Case Qty.
.75"	.75"	<b>STF0132SG</b>	4
.75"	.98"	<b>STF0133SG</b>	4



Diameter	Barrel Length	Satin Gold Part #	Case Qty.
.98"	.75"	<b>STF0142SG</b>	4
.98"	.98"	<b>STF0143SG</b>	4

Prices are per piece.  
Sold in full cases of 4 only.



### STFSET3

Stand-Offs Display  
Includes 1 each of Kota Pro  
Black, Gold, Silver, Red & Blue  
Stand-Offs & Screw Caps on  
Laserable Leatherette  
background.  
Size: 16" x 20"



Stand-Offs

## Kota Pro™ Colored Aluminum Stand-Offs

### Aluminum Stand-Offs:

- Suitable for indoor applications
- Include drywall screws and anchors for installation
- Sold in packs of 4 only
- Required holes in signage substrate:  
STF011XXX & STF012XXX: .31"  
STF013XXX & SFT014XXX: .39"



Stand-Offs



Diameter	Barrel Length	Black Part #	Gold Part #	Case Qty.
.51"	.51"	STF0111BK	STF0111GD	4
.51"	.75"	STF0112BK	STF0112GD	4
.51"	.98"	STF0113BK	STF0113GD	4



Diameter	Barrel Length	Black Part #	Gold Part #	Case Qty.
.59"	.59"	STF0121BK	STF0121GD	4
.59"	.78"	STF0122BK	STF0122GD	4
.59"	.98"	STF0123BK	STF0123GD	4



Diameter	Barrel Length	Black Part #	Gold Part #	Case Qty.
.75"	.75"	STF0132BK	STF0132GD	4
.75"	.98"	STF0133BK	STF0133GD	4



Diameter	Barrel Length	Black Part #	Gold Part #	Case Qty.
.98"	.75"	STF0142BK	STF0142GD	4
.98"	.98"	STF0143BK	STF0143GD	4

Prices are per piece.  
Sold in full cases of 4 only.



**STFSET3**  
Stand-Offs Display  
Includes 1 each of Kota Pro  
Black, Gold, Silver, Red & Blue  
Stand-Offs & Screw Caps on  
Laserable Leatherette  
background.  
Size: 16" x 20"





## Kota Pro™ Colored Aluminum Stand-Offs

### Aluminum Stand-Offs:

- Suitable for indoor applications
- Includes drywall screws and anchors for installation
- Sold in packs of 4 only
- Required holes in signage substrate:  
 STF011XXX & STF012XXX: .31"  
 STF013XXX & STF014XXX: .39"

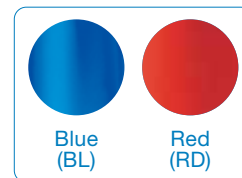

Diameter	Barrel Length	Blue Part #	Red Part #	Case Qty.
.51"	.51"	STF0111BL	STF0111RD	4
.51"	.75"	STF0112BL	STF0112RD	4
.51"	.98"	STF0113BL	STF0113RD	4

Diameter	Barrel Length	Blue Part #	Red Part #	Case Qty.
.59"	.59"	STF0121BL	STF0121RD	4
.59"	.78"	STF0122BL	STF0122RD	4
.59"	.98"	STF0123BL	STF0123RD	4

Diameter	Barrel Length	Blue Part #	Red Part #	Case Qty.
.75"	.75"	STF0132BL	STF0132RD	4
.75"	.98"	STF0133BL	STF0133RD	4

Diameter	Barrel Length	Blue Part #	Red Part #	Case Qty.
.98"	.75"	STF0142BL	STF0142RD	4
.98"	.98"	STF0143BL	STF0143RD	4

Prices are per piece.  
Sold in full cases of 4 only.



Stand-Offs

## Kota Pro™ Stand-Offs & Screw Caps

### Stainless Steel Stand-Offs:

- Outdoor and indoor weatherable
- Include drywall screws and anchors for installation
- Sold in packs of 4 only
- Required holes in signage substrate:  
STF0212NA & STF0221NA: .31"  
STF0232NA & STF0233NA: .39"



Diameter	Barrel Length	Stainless Steel Part #	Case Qty.
.51"	.75"	<b>STF0212NA</b>	4
.63"	.63"	<b>STF0221NA</b>	4
.75"	.75"	<b>STF0232NA</b>	4
.75"	.98"	<b>STF0233NA</b>	4

### Aluminum Side Clamps:

- Suitable for indoor applications
- Include drywall screws and anchors for installation
- Sold in packs of 4 only



Satin Silver Side Clamps			
Diameter	Barrel Length	Part #	Case Qty.
.63"	.75"	<b>STF0311ST</b>	4
.75"	.98"	<b>STF0322ST</b>	4
.98"	1.46"	<b>STF0333ST</b>	4

### Aluminum Screw Caps:

- Suitable for indoor applications
- Include drywall screws, anchors & washers for installation
- Sold in packs of 4 only



Polished Chrome Aluminum Screw Caps		
Diameter	Polished Chrome Part #	Case Qty.
.47"	<b>STF0411CP</b>	4
.75"	<b>STF0421CP</b>	4
.98"	<b>STF0431CP</b>	4



Satin Chrome Aluminum Screw Caps		
Diameter	Satin Chrome Part #	Case Qty.
.47"	<b>STF0411SC</b>	4
.75"	<b>STF0421SC</b>	4
.98"	<b>STF0431SC</b>	4



Black Aluminum Screw Caps		
Diameter	Satin Chrome Part #	Case Qty.
.47"	<b>STF0411BK</b>	4
.75"	<b>STF0421BK</b>	4
.98"	<b>STF0431BK</b>	4



Gold Aluminum Screw Caps		
Diameter	Satin Chrome Part #	Case Qty.
.47"	<b>STF0411GD</b>	4
.75"	<b>STF0421GD</b>	4
.98"	<b>STF0431GD</b>	4

## KOTA<sub>PRO</sub>

Sold in full cases of 4 only.



Stainless Steel (NA)

Prices are per piece.  
Sold in full cases of 4 only.



Satin Silver (ST)

Prices are per piece.  
Sold in full cases of 4 only.

## Kota Pro™ Screw Caps

**KOTA<sub>PRO</sub>**

Sold in full cases of 4 only.

### Aluminum Screw Caps:

- Suitable for indoor applications
- Includes drywall screws, anchors & washers for installation
- Sold in packs of 4 only

Blue Aluminum Screw Caps		
Diameter	Blue Part #	Case Qty.
.47"	STF0411BL	4
.75"	STF0421BL	4
.98"	STF0431BL	4



Satin Gold Aluminum Screw Caps		
Diameter	Satin Gold Part #	Case Qty.
.47"	STF0411SG	4
.75"	STF0421SG	4
.98"	STF0431SG	4



Red Aluminum Screw Caps		
Diameter	Red Part #	Case Qty.
.47"	STF0411RD	4
.75"	STF0421RD	4
.98"	STF0431RD	4



Prices are per piece.  
Sold in full cases of 4 only.



**STFSET3**  
Stand-Offs Display  
Includes 1 each of Kota Pro Black, Gold, Silver, Red & Blue Stand-Offs & Screw Caps on Laserable Leatherette background.  
Size: 16" x 20"

Stand-Offs



## Kota Pro™ ADA Signs

Save time and money with these pre-made, ready-to-hang ADA signs.

*Signs are 1/8" thick. Raised white text & graphics. Signs include raised braille text.*

**KOTA<sub>PRO</sub>**

**Black Sample Set #ADASET1**

Includes 1 of each ADA101-109 & ADA69

**Blue Sample Set #ADASET2**

Includes 1 of each ADA201-209 & ADA69



Description	Black/White Part #	Blue/White Part #	Case Qty.
6" x 9" MEN Accessible Restroom Sign	<b>ADA101</b>	<b>ADA201</b>	24
6" x 9" WOMEN Accessible Restroom Sign	<b>ADA102</b>	<b>ADA202</b>	24
6" x 9" Unisex Accessible Restroom Sign	<b>ADA103</b>	<b>ADA203</b>	24

ADA Signs



Description	Black/White Part #	Blue/White Part #	Case Qty.
6" x 9" MEN Restroom Sign	<b>ADA105</b>	<b>ADA205</b>	24
6" x 9" WOMEN Restroom Sign	<b>ADA106</b>	<b>ADA206</b>	24
6" x 9" Unisex Restroom Sign	<b>ADA104</b>	<b>ADA204</b>	24

# Kota Pro™ ADA Signs

## KOTA<sub>PRO</sub>™

*Signs are 1/8" thick. Raised white text & graphics. Signs include raised braille text.*

**Black Sample Set #ADASET1**

Includes 1 of each ADA101-109 & ADA69

**Blue Sample Set #ADASET2**

Includes 1 of each ADA201-209 & ADA69



Description	Black/White Part #	Blue/White Part #	Case Qty.
6" x 9" NO SMOKING Sign	ADA107	ADA207	24
6" x 9" STAIRS Sign	ADA108	ADA208	24
6" x 6" EXIT Sign	ADA109	ADA209	24

*See pages 251-253 for Duets ADA & Applique Sheet Stock and Braille Beads*



ADA69 shown with ADA207



Description	Part #	Case Qty.
6" x 9" Frame for ADA Signs	ADA69	24
Screws for ADA69 Frame	H60G	100

ADA Signs



**ADAPOPDISPLAY**

ADA POP Display  
Size: 11 5/8" x 22"

## Pronto™ Changeable Copy

Gemini Pronto Changeable Copy is a cut above traditional saw-cut copy. Pieces are made from an injection molded precision blank and each panel is molded with a small raised edge on the back that prevents the ink from being scratched off. The molded-in feet keep debris and ice from interfering with the placement and because the inks used are UV inks, there are no harmful emissions during manufacturing.



*Important Note:*  
To order, you need both  
*Letter Height and Panel Height*

Changeable Copy

### Pronto Commercial Set (Letters & Numbers Only)

Each	100
E	7
A I	6
O U	5
L N R S T P	4
F G H M	3
B C D	3
J K V W Y Z	2
Q X \$ ¢	1
0 1 2 3 4 5 6 7 8 9	1

### Pronto Punctuation Set

Each	50
Ampersand	& 2
Period	. 2
Comma	, 2
Exclamation	! 2
Dash	- 2
Question	? 2
Colon	: 2
Semi Colon	; 2
Left Quote	" 2
Right Quote	" 2
Apostrophe	' 2
Slash	/ 2
Dollar Sign	\$ 2
Cent Sign	¢ 2
Percent	% 1
One Half	½ 2
One Quarter	¼ 2
Plus	+ 1
Left Parenthesis	( 2
Right Parenthesis	) 2
At Sign	@ 2
Hashtag	# 2
Facebook	f 2
Linkedin	in 2
Twitter	🐦 2
.com	.com 2

### Punctuation Part # Abbreviation

Punctuation	Part#	Abbreviation
Ampersand	&	AND
Period	.	PERIOD
Comma	,	COMMA
Exclamation	!	EXC
Dash	-	DASH
Question	?	QUES
Colon	:	COLON
Semi Colon	;	SEMICOL
Left Quote	"	LQUOTE
Right Quote	"	RQUOTE
Apostrophe	'	APOST
Slash	/	SLASH
Dollar Sign	\$	DOLLAR
Cent Sign	¢	CENT
Percent	%	PERCENT
One Half	½	HALF
One Quarter	¼	QUART
Plus	+	PLUS
Left Parenthesis	(	LPAREN
Right Parenthesis	)	RPAREN
At Sign	@	AT
Hashtag	#	HASH
Facebook	f	FB
Linkedin	in	LINK
Twitter	🐦	TWEET
.com	.com	COM



**Pronto™ Changeable Copy**

**MODERN**

ABCDEFGHIJKLMNOPQRSTUVWXYZ  
1234567890

100 Piece Set

Letter Height	Panel Height	Avg. Panel Width	Part # Black	Part # Black/Red	Part # Red
3"	3 7/8"	2 3/8"	P03MODi100BK	P03MODi100BR	P03MODi100RD
4"	4 7/8"	3"	P04MODi100BK	P04MODi100BR	P04MODi100RD
6"	6 7/8"	4"	P06MODi100BK	P06MODi100BR	P06MODi100RD
8" on 9"	8 7/8"	5 1/2"	P89MODi100BK	P89MODi100BR	P89MODi100RD
8"	9 7/8"	5 1/2"	P08MODi100BK	P08MODi100BR	P08MODi100RD
10"	11 7/8"	6 3/4"	P10MODi100BK	P10MODi100BR	P10MODi100RD

50 Piece Set

**MODERN**

**PUNCTUATION**

. , ; : - & \$ ? !  
' " " ¼ ½ % / ( ) +  
@ # f in .com

Letter Height	Panel Height	Avg. Panel Width	Part # Black	Part # Red
3"	3 7/8"	2 3/8"	P03MODi50PBK	P03MODi50PRD
4"	4 7/8"	3"	P04MODi50PBK	P04MODi50PRD
6"	6 7/8"	4"	P06MODi50PBK	P06MODi50PRD
8" on 9"	8 7/8"	5 1/2"	P89MODi50PBK	P89MODi50PRD
8"	9 7/8"	5 1/2"	P08MODi50PBK	P08MODi50PRD
10"	11 7/8"	6 3/4"	P10MODi50PBK	P10MODi50PRD

How to build an Individual Letter/Punctuation part number.

**P03MODABK**

Letter Height: P  
Font: 03  
Letter, Number or Punctuation character that you want to order: MODABK  
Color: BK

punctuation abbreviation chart



**MODERN**

INDIVIDUAL LETTERS & PUNCTUATION

Important Note: How to make sure your Individual Letter part number is built correctly.

- All Pronto part numbers start with "P" for Pronto.
- The next two digits indicate the Letter Height.
- The next three digits indicate the Letter Font. There are three fonts available: MOD, ADM or CON
- The next digit indicates the Letter, Number or Punctuation Character you want to order.
- The last two digits: "BK" indicate the letter color. All individual letters are only stocked in black.

Part#	Letter Height	Panel Height	Avg. Panel Width
P03MOD_BK	3"	3 7/8"	2 3/8"
P04MOD_BK	4"	4 7/8"	3"
P06MOD_BK	6"	6 7/8"	4"
P89MOD_BK	8" on 9"	8 7/8"	5 1/2"
P08MOD_BK	8"	9 7/8"	5 1/2"
P10MOD_BK	10"	11 7/8"	6 3/4"

NOTE: Pronto letters enclosed in a sealed vandal proof cover require venting or warping may occur.



AP Customers get 100+ pricing when ordering 25 or more individual letters.

**Pronto™ Changeable Copy**

**ADM**

ABCDEFGHIJKLMNOPQRSTUVWXYZ  
1234567890

100 Piece Set

Letter Height	Panel Height	Avg. Panel Width	Part # Black	Part # Black/Red	Part # Red
4"	4 7/8"	3 1/2"	P04ADMi100BK	P04ADMi100BR	P04ADMi100RD
6"	6 7/8"	4 5/8"	P06ADMi100BK	P06ADMi100BR	P06ADMi100RD
8" on 9"	8 7/8"	6 3/4"	P89ADMi100BK	P89ADMi100BR	P89ADMi100RD
8"	9 7/8"	6 3/4"	P08ADMi100BK	P08ADMi100BR	P08ADMi100RD
10"	11 7/8"	7 1/2"	P10ADMi100BK	P10ADMi100BR	P10ADMi100RD

50 Piece Set

Changeable Copy

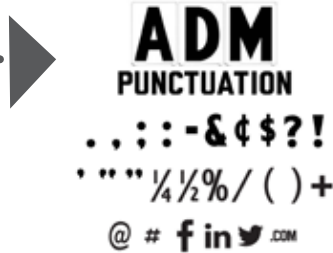

Letter Height	Panel Height	Avg. Panel Width	Part # Black	Part # Red
4"	4 7/8"	3"	P04ADMi50PBK	P04ADMi50PRD
6"	6 7/8"	4"	P06ADMi50PBK	P06ADMi50PRD
8" on 9"	8 7/8"	5 1/2"	P89ADMi50PBK	P89ADMi50PRD
8"	9 7/8"	5 1/2"	P08ADMi50PBK	P08ADMi50PRD
10"	11 7/8"	6 3/4"	P10ADMi50PBK	P10ADMi50PRD

How to build an Individual Letter/Punctuation part number.

**P04ADMi1BK**

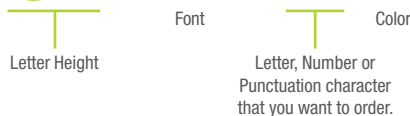

**ADM**

**INDIVIDUAL LETTERS & PUNCTUATION**

Important Note: How to make sure your Individual Letter part number is built correctly.

- All Pronto part numbers start with "P" for Pronto.
- The next two digits indicate the Letter Height.
- The next three digits indicate the Letter Font. There are three fonts available: MOD, ADM or CON
- The next digit indicates the Letter, Number or Punctuation Character you want to order.
- The last two digits "BK" indicate the letter color. All individual letters are only stocked in black.

Part#	Letter Height	Panel Height	Avg. Panel Width
P04ADM_BK	4"	4 7/8"	3"
P06ADM_BK	6"	6 7/8"	4"
P89ADM_BK	8" on 9"	8 7/8"	5 1/2"
P08ADM_BK	8"	9 7/8"	5 1/2"
P10ADM_BK	10"	11 7/8"	6 3/4"

Stocked in St. Louis, MO.

punctuation abbreviation chart on page 200

NOTE: Pronto letters enclosed in a sealed vandal proof cover require venting or warping may occur.



AP Customers get 100+ pricing when ordering 25 or more individual letters.

**Pronto™ Changeable Copy**

**CONDENSED**

ABCDEFGHIJKLMNOPQRSTUVWXYZ  
1234567890 **100 Piece Set**

Letter Height	Panel Height	Avg. Panel Width	Part # Black	Part # Black/Red	Part # Red
4"	4 7/8"	2 3/8"	P04CONi100BK	P04CONi100BR	P04CONi100RD
6"	6 7/8"	3 1/4"	P06CONi100BK	P06CONi100BR	P06CONi100RD
8" on 9"	8 7/8"	4 7/8"	P89CONi100BK	P89CONi100BR	P89CONi100RD
8"	9 7/8"	4 3/8"	P08CONi100BK	P08CONi100BR	P08CONi100RD
10"	11 7/8"	5 1/2"	P10CONi100BK	P10CONi100BR	P10CONi100RD

**50 Piece Set**

**CONDENSED**  
PUNCTUATION  
, , ; : - & € \$ ? !  
' " " ¼ ½ % / ( ) +  
@ # f in ⓧ .com

Letter Height	Panel Height	Avg. Panel Width	Part # Black	Part # Red
4"	4 7/8"	3"	P04CONi50PBK	P04CONi50PRD
6"	6 7/8"	4"	P06CONi50PBK	P06CONi50PRD
8" on 9"	8 7/8"	5 1/2"	P89CONi50PBK	P89CONi50PRD
8"	9 7/8"	5 1/2"	P08CONi50PBK	P08CONi50PRD
10"	11 7/8"	6 3/4"	P10CONi50PBK	P10CONi50PRD

*How to build an Individual Letter/Punctuation part number.*

**P89CONGBK**

Letter Height: P  
Font: 89CON  
Color: GBK

Letter, Number or Punctuation character that you want to order.



**CONDENSED**

**INDIVIDUAL LETTERS & PUNCTUATION**

**Important Note:** How to make sure your Individual Letter part number is built correctly.

- All Pronto part numbers start with "P" for Pronto.
- The next two digits indicate the Letter Height.
- The next three digits indicate the Letter Font. There are three fonts available: MOD, ADM or CON
- The next digit indicates the Letter, Number or Punctuation Character you want to order.
- The last two digits "BK" indicate the letter color. All individual letters are only stocked in black.

Part#	Letter Height	Panel Height	Avg. Panel Width
P04CON_BK	4"	4 7/8"	3"
P06CON_BK	6"	6 7/8"	4"
P89CON_BK	8" on 9"	8 7/8"	5 1/2"
P08CON_BK	8"	9 7/8"	5 1/2"
P10CON_BK	10"	11 7/8"	6 3/4"

Stocked in St. Louis, MO.

punctuation abbreviation chart on page 200

NOTE: Pronto letters enclosed in a sealed vandal proof cover require venting or warping may occur.



AP Customers get 100+ pricing when ordering 25 or more individual letters.

Changeable Copy



## Pronto™ Storage Cabinets



Wheeled cabinets also available.



Stores approximately 300 letters.  
Smaller cabinet comes in 2 sections.

Letter Size	Cabinet Dimensions			Part #	with Wheels Part #
	Depth	Width	Height		
4" - 6"	7 1/4"	23 3/4"	17 1/2"	<b>P06iMSC</b>	<b>P06iMSCW</b>
8" - 10"	11 1/2"	23 3/4"	20 1/2"	<b>P10iMSC</b>	<b>P10iMSCW</b>

Changeable Copy

## Pronto™ Change Arms & Accessories

NOTE: All Gemini Change Arms are sent with aluminum ratchets & head assemblies.

Telescoping Fiberglass Pole



Part #	Description
<b>P12ARMA</b>	6' to 12' Change Arm with 3 3/4" D Cup
<b>P12ARMD</b>	6' to 12' Change Arm with 2" D Cup
<b>P18ARMA</b>	6' to 18' Change Arm with 3 3/4" D Cup
<b>P18ARMD</b>	6' to 18' Change Arm with 2" D Cup
<b>P24ARMA*</b>	8' to 24' Change Arm with 3 3/4" D Cup
<b>P24ARMD*</b>	8' to 24' Change Arm with 2" D Cup

\*NOTE: Additional shipping charge applies on 24' arms.  
24' arms cannot ship on truck shipments.  
Will call pickup available in Missouri, New Jersey,  
Visalia & Georgia warehouses.  
Call for details.

## Pronto™ Change Arm Assembly and Cup Replacements



Part #	Description
P02CUP	2" Change Arm Cup Only
P03CUP	3 3/4" Change Arm Cup Only
P00CRAT	Change Arm Ratchet & Receiver, Cast Aluminum
P02HEAD	Change Arm Head Assembly with 2" D Cup
P03HEAD	Change Arm Head Assembly with 3 3/4" D Cup



## Pronto™ Changeable Copy, Acrylic Track & Rivets



Track Length	Part # Bottom Profile	Part # Dual Profile	Part # Top Profile
8'	T08ACRYB	T08ACRYD	T08ACRYT
10'	T10ACRYB	T10ACRYD	T10ACRYT
12'	T12ACRYB	T12ACRYD	T12ACRYT

### Clear Acrylic Mini Track

Track Length	Part # Dual Profile
8'	T08ACRYM
10'	T10ACRYM
12'	T12ACRYM



### Track Rivets

Part #	Description	Total Thickness Range*	Rivet Diameter
P00PRL	100 Pack Large White Rivets (Acrylic Track)	.375 - .500	0.18
P00PRM	100 Pack Medium White Rivets (Polycarbonate Track)	.290 - .440	0.18

\*Includes track & panel thickness

### Top to Bottom Height

Lines of Copy	3" Letter	4" Letter	6" Letter	8" on 9" Letter	8" Letter	10" Letter
1	5 1/2"	6 1/2"	8 1/2"	10 1/2"	11 1/2"	13 1/2"
2	10 3/8"	12 3/8"	16 3/8"	20 3/8"	22 3/8"	26 3/8"
3	15 1/4"	18 1/4"	24 1/4"	30 1/4"	33 1/4"	39 1/4"
4	20 1/8"	24 1/8"	32 1/8"	40 1/8"	44 1/8"	52 1/8"
5	25"	30"	40"	50"	55"	65"

### Visible Opening for Track Spacing

3" Letter	4" Letter	6" Letter	8" on 9" Letter	8" Letter	10" Letter
3 1/4"	4 1/4"	6 1/4"	8 1/4"	9 1/4"	11 1/4"

### Acrylic Track

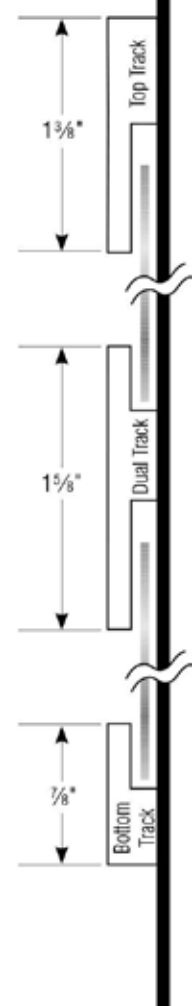

Changeable Copy

**NEW Kota Pro™ Desk Holders & Wall Brackets**

Desk Holders & Wall Brackets are for 1/16" Plastic.

**KOTA<sub>PRO</sub>**

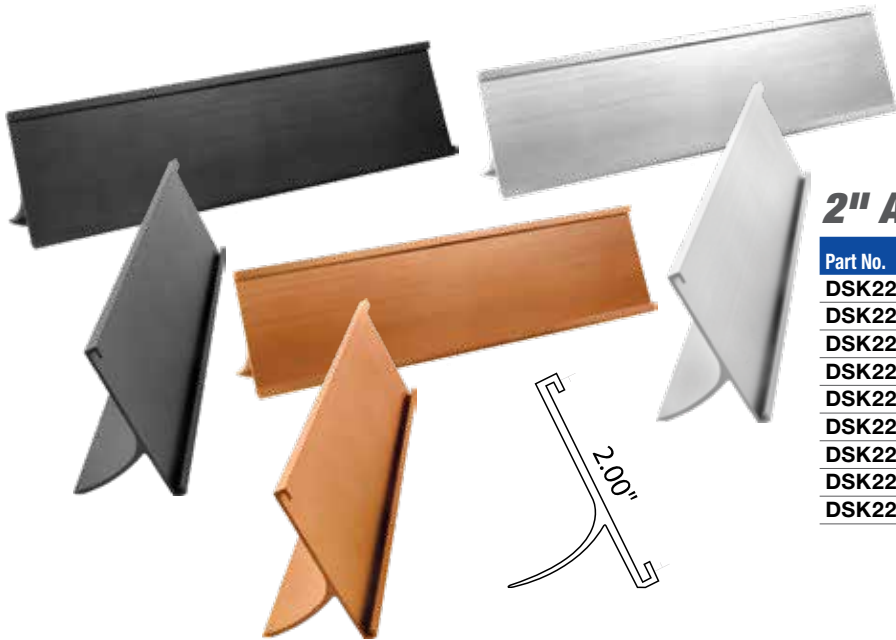

**2" Aluminum Desk Holders**

Part No.	Description	Case Qty.
<b>DSK228BK</b>	2" x 8" Black Desk Holder	5
<b>DSK228G</b>	2" x 8" Rose Gold Desk Holder	5
<b>DSK228S</b>	2" x 8" Shiny Silver Desk Holder	5
<b>DSK2210BK</b>	2" x 10" Black Desk Holder	5
<b>DSK2210G</b>	2" x 10" Rose Gold Desk Holder	5
<b>DSK2210S</b>	2" x 10" Shiny Silver Desk Holder	5
<b>DSK2212BK</b>	2" x 12" Black Desk Holder	5
<b>DSK2212G</b>	2" x 12" Rose Gold Desk Holder	5
<b>DSK2212S</b>	2" x 12" Shiny Silver Desk Holder	5

**1" Aluminum Wall Bracket**

Part No.	Description	Case Qty.
<b>WLL214G</b>	1" x 4" Rose Gold Desk Holder	10
<b>WLL214S</b>	1" x 4" Shiny Silver Desk Holder	10
<b>WLL216G</b>	1" x 6" Rose Gold Desk Holder	10
<b>WLL216S</b>	1" x 6" Shiny Silver Desk Holder	10
<b>WLL218G</b>	1" x 8" Rose Gold Desk Holder	10
<b>WLL218S</b>	1" x 8" Shiny Silver Desk Holder	10
<b>WLL2110G</b>	1" x 10" Rose Gold Desk Holder	10
<b>WLL2110S</b>	1" x 10" Shiny Silver Desk Holder	10
<b>WLL2112G</b>	1" x 12" Rose Gold Desk Holder	10
<b>WLL2112S</b>	1" x 12" Shiny Silver Desk Holder	10

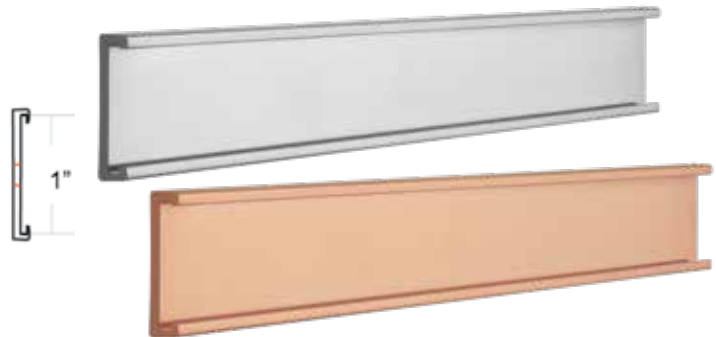

**2" Aluminum Wall Bracket**

Part No.	Description	Case Qty.
<b>WLL224G</b>	2" x 4" Rose Gold Wall Bracket	10
<b>WLL224S</b>	2" x 4" Shiny Silver Wall Bracket	10
<b>WLL226G</b>	2" x 6" Rose Gold Wall Bracket	10
<b>WLL226S</b>	2" x 6" Shiny Silver Wall Bracket	10
<b>WLL228BK</b>	2" x 8" Black Wall Bracket	10
<b>WLL228G</b>	2" x 8" Rose Gold Wall Bracket	10
<b>WLL228S</b>	2" x 8" Shiny Silver Wall Bracket	10
<b>WLL2210BK</b>	2" x 10" Black Wall Bracket	10
<b>WLL2210G</b>	2" x 10" Rose Gold Wall Bracket	10
<b>WLL2210S</b>	2" x 10" Shiny Silver Wall Bracket	10
<b>WLL2212BK</b>	2" x 12" Black Wall Bracket	10
<b>WLL2212G</b>	2" x 12" Rose Gold Wall Bracket	10
<b>WLL2212S</b>	2" x 12" Shiny Silver Wall Bracket	10



Desk Holders & Wall Brackets



### Custom IntePro® Corrugated Plastic Blanks

Production time is typically 3-5 days (upon receipt of artwork and depending on size of order). Certain parameters and requirements apply. Our Customer Order Specialists will help you in making this determination. Call for quote on custom graphics. FOB SD Only.

**CONTACT  
US TODAY!**  
**855.537.2228**  
**Custom Order  
Specialists**



Corrugated Plastic Blanks



## IntePro® Corrugated Plastic Blanks & H Stakes

IntePro® is a tough, waterproof, corrugated plastic sign material. The hollow-fluted design of IntePro® makes the material extremely lightweight, easy to handle and simple to display in a number of ways. Blanks and Stakes sold separately.

Case Qty: 50



**CP042418W**

4mm White  
24" x 18"

**CP041824W**

4mm White  
18" x 24"

Stakes Sold Separately



Detail of IntePro®

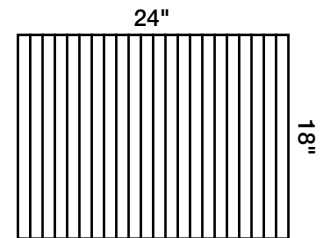

CP042418W Flute Direction

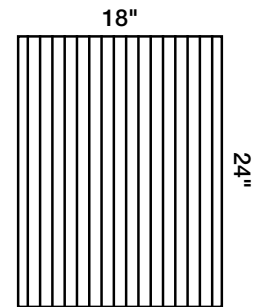

CP041824W Flute Direction



Part No.	Case Qty.
CP042418W	50
CP041824W	50
*STK101	50
*STK102	100
*STK103	25

Note:

\*Stakes Sold in Full Cases Only.

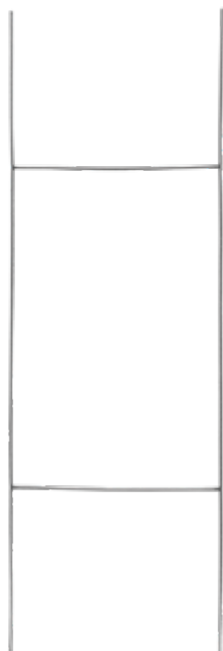

**STK101**  
9 Gauge Galvanized  
Steel H Sign Stake  
10" x 30"



**STK102**  
9 Gauge Galvanized  
Steel H Sign Stake  
10" x 24"

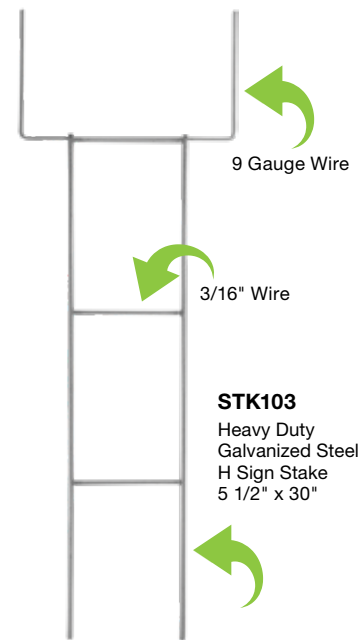

**STK103**  
Heavy Duty  
Galvanized Steel  
H Sign Stake  
5 1/2" x 30"

**NEW** Kota Pro™ H Stakes

**KOTA**PRO™

Save money without sacrificing quality when you order Kota Pro yard stakes for corrugated plastic signs. Kota Pro stakes are made with standard 9 gauge galvanized steel. Available in two different lengths, they are guaranteed not to rust.

- Designed for use with 4mm corrugated plastic signs
- Prongs fit into vertical flutes
- Available in 24" and 30" lengths

Case Qty: 50



**STK201**  
9 Gauge Smooth Galvanized Steel  
10" x 30"



**STK202**  
9 Gauge Smooth Galvanized Steel  
10" x 24"



H Stakes





## Cast Aluminum Plaques with 24" Aluminum Rod

Plaques have raised, double borders and 1/16" recessed area for an engraved plate. Plaques are 1/4" thick. Plaques come with 24" aluminum rod for mounting. Engraving sheet stock sold separately.

Case Qty: 1

Indoor/Outdoor

### CAS6106

Silver/Black  
Size: 10" x 6"  
Plate Area: 8 3/4" x 4 3/4"

### CAS6127

Silver/Black  
Size: 12" x 7 1/2"  
Plate Area: 10 3/4" x 6 1/4"

### CAS61510

Silver/Black  
Size: 14 3/4" x 9 3/4"  
Plate Area: 13 3/8" x 8 3/8"



Back of Plaque with Aluminum Rod

### SAMPLE SET #CASSET6

1 of each Silver/Black Aluminum Sign with 24" Rods

Plaques



## Cast Aluminum Plaques with Mounting Screws

Plaques have raised, double borders and 1/16" recessed area for an engraved plate. Plaques come with 4 screws for mounting. Plaques are 1/4" thick. Engraving sheet stock sold separately.

Case Qty: 1

Indoor/Outdoor

### CAS7106

Silver/Black  
Size: 10" x 6"  
Plate Area: 8 3/4" x 4 3/4"

### CAS7127

Silver/Black  
Size: 12" x 7 1/2"  
Plate Area: 10 3/4" x 6 1/4"

### CAS71510

Silver/Black  
Size: 14 3/4" x 9 3/4"  
Plate Area: 13 3/8" x 8 3/8"



### SAMPLE SET #CASSET7

1 of each Silver/Black Aluminum Sign with 4 Mount Screws



Comes with set of 4 Mount Screws



## Cast Aluminum Plaques with 24" Aluminum Rod

Plaques have raised, double borders and 1/16" recessed area for an engraved plate. Plaques are 1/4" thick. Plaques come with 24" aluminum rod for mounting. Engraving sheet stock sold separately.  
Case Qty: 1

Indoor/Outdoor

### CAS164

Silver/Black  
Size: 6" x 4"  
Plate Area: 5" x 3"

### CAS186

Silver/Black  
Size: 8" x 6"  
Plate Area: 7" x 5"

### CAS1108

Silver/Black  
Size: 10" x 8"  
Plate Area: 9" x 7"

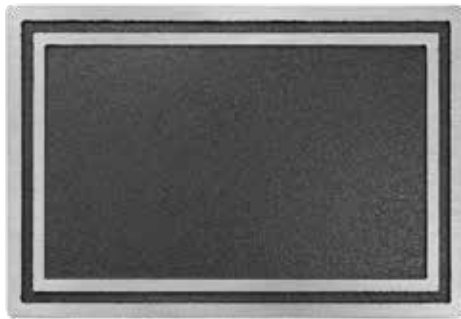

Indoor

### CAS264

Bronze/Brown  
Size: 6" x 4"  
Plate Area: 5" x 3"

### CAS286

Bronze/Brown  
Size: 8" x 6"  
Plate Area: 7" x 5"

### CAS2108

Bronze/Brown  
Size: 10" x 8"  
Plate Area: 9" x 7"



Engraving Sheet Stock Sold Separately.



Back of Plaque with Aluminum Rod

### SAMPLE SET #CASSET1

1 of each Silver/Black Aluminum Sign with 24" Rods

### SAMPLE SET #CASSET2

1 of each Bronze/Brown Aluminum Sign with 24" Rods

## Cast Aluminum Plaques with Mounting Screws

Plaques have raised, double borders and 1/16" recessed area for an engraved plate. Plaques come with 4 screws for mounting. Plaques are 1/4" thick. Engraving sheet stock sold separately.  
Case Qty: 1

Indoor/Outdoor

### CAS393

Silver/Black  
Size: 9" x 3"  
Plate Area: 8" x 2"

### CAS364

Silver/Black  
Size: 6" x 4"  
Plate Area: 5" x 3"

### CAS386

Silver/Black  
Size: 8" x 6"  
Plate Area: 7" x 5"

### CAS3108

Silver/Black  
Size: 10" x 8"  
Plate Area: 9" x 7"

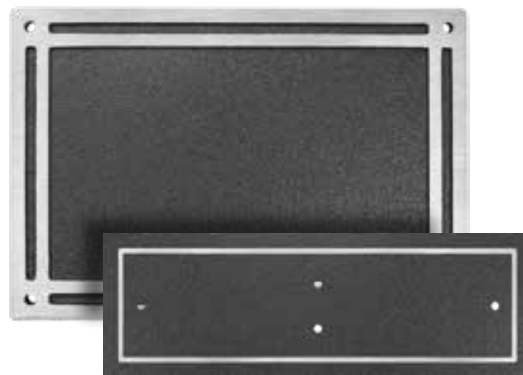

Indoor

### CAS493

Bronze/Brown  
Size: 9" x 3"  
Plate Area: 8" x 2"

### CAS464

Bronze/Brown  
Size: 6" x 4"  
Plate Area: 5" x 3"

### CAS486

Bronze/Brown  
Size: 8" x 6"  
Plate Area: 7" x 5"

### CAS4108

Bronze/Brown  
Size: 10" x 8"  
Plate Area: 9" x 7"



### SAMPLE SET #CASSET3

1 of each Silver/Black Aluminum Sign with 4 Mount Screws

### SAMPLE SET #CASSET4

1 of each Bronze/Brown Aluminum Sign with 4 Mount Screws



9000-160





# Equipment

*if you're looking for:*

**PLOTTER CUTTERS**

**HEAT PRESSES & STANDS**

**HEAT PRESS SUPPLIES**

**CORNER SHAPERS**

**SHEARS**

**ENGRAVING TOOLS & SUPPLIES**

**Graphtec FC9000 Series**

All New, FC9000 Series, High-Performance Cutting Plotters. The Elite FC9000 Series Plotters can now load and cut via USB Flash Memory without a PC.



**FC9000-75**  
30" Graphtec Cutting Plotter



**FC9000-100**  
42" Graphtec Cutting Plotter

**HIGH PERFORMANCE**  
**STRONG • FAST • PRECISE**



**FC9000-140**  
54" Graphtec Cutting Plotter



**FC9000-160**  
64" Graphtec Cutting Plotter

Plotter Cutters

**Load and Cut Via USB Flash Memory without a PC!**

**Re-Engineered for Greatness**

A re-engineered feeding system, tool head, and new ARMS sensor further contribute to the FC Series' class leading performance.

**Print & Cut Perfected**

New ARMS 8.0 features the introduction of the Datalink Barcode System in addition to other accuracy and efficiency boosting functions.

**All-in-One System**

Easily create and cut high quality designs with Cutting Master 4 and Graphtec Pro Studio software. Included Media Flanges and Blade Loupe ensure accurate tracking and blade setup.



**Best In Class Ability**

Wider range of compatible medias from thick to thin. Minimum cutting width of 1.96".

**Max Cutting Force**

**600 grams**

**Max Cutting Speed up to**

**58.46 in/s**

**Max Acceleration**

**1543 in/s<sup>2</sup>**

**ISM Intelligent Scan Mode**

Accurately cuts graphics printed on high intensity reflective, ultra-gloss and textured media.

**Expanded Area Cutting**

Cuts outside the registration marks. Yields up to 30% higher output.

**3 Year Limited Warranty**

Parts & Labor

**FREE SHIPPING!**

*in 48 contiguous states*

**Graphtec CE7000 Series**



**CE7000-40**  
15" Graphtec Cutting Plotter



**CE7000-60**  
24" Graphtec Cutting Plotter



**CE7000-130**  
50" Graphtec Cutting Plotter

**Increased Max Cutting Force**

**450 grams**

**ARMS 8.0**

Graphtec's renowned Advanced Registration Mark Sensing system produces highly accurate print & cut results. Produce copies without a PC connection.

- Tangential Emulation
- Digital Servo Motors
- 2-Year Standard Warranty

**Max Cutting Speed up to**

- 24 in/s (40)
- 35 in/s (60)
- 39 in/s (130)

**Intuitive Operation**

User friendly 3.3" LCD Control Panel. EZ-to-use in simple operation mode.

**Software Included**



**Max Cutting Area**

- 15" x 164" (40)
- 24" x 164" (60)
- 50" x 164" (130)

**Expanded Area Cutting**

Cuts outside the registration marks. Yields up to 30% higher output.

**FREE SHIPPING!**

*in 48 contiguous states*

**CE7000 Plus/FC9000 Series Accessories**

Accessories are for both the CE7000-Plus & FC9000 Series unless noted otherwise.



**CE6-CM60-2**  
Graphtec Teflon Mat/Strip  
2-Pack for CE7000 Plotter



**CB15U-2**  
2 Pack Supersteel Blade  
Angle: 45°  
Diameter: 1.5mm



**CB09UB-2**  
2 Pack Supersteel Blade  
Angle: 45°  
Diameter: 0.9mm

**CB15U-5**  
5 Pack Supersteel Blade  
Angle: 45°  
Diameter: 1.5mm

**CB09UB-5**  
5 Pack Supersteel Blade  
Angle: 45°  
Diameter: 0.9mm



**PG0103**  
CE7000-60  
Media Basket



**PG0104**  
CE7000-130  
Media Basket



**PHP33-CB09N-HS**  
0.9MM Cutting Blade Holder



**PHP33-CB15N-HS**  
1.5MM Cutting Blade Holder

Part #	Description
<b>GPP-CE7000</b>	CE7000 Series 5 Year Warranty Protection Plan
<b>GPP-FC9000</b>	CE9000 Protection Plan
<b>OGP4-FC9000</b>	CE9000 On Site 4 Year Warranty Protection Plan
<b>OGP5-FC9000</b>	CE9000 On Site 5 Year Warranty Protection Plan

Plotter Cutters



# Geo Knight & Co, Inc. Heat Presses & Supplies



D B R L S SC



**GKDK14S**  
12" x 14" Swing-Away Press

**FEATURES**

- Compact Portable Table-Top Design
- Fully digital temperature control 32°-600°F range
- Automatic digital timer & dual pre-press timer
- Super-portable light machine weight - 62 lbs!
- Extreme high pressure capability
- Solid Steel framework
- SuperCoil-Microwinding™ heater technology
- Accommodates materials up to 2" thick
- Temperature readout accuracy +/-2°F - can show °C or °F
- User selectable end-of-cycle alarms
- Records number of pressing cycles done
- Teflon-coated 3/4" thick heat platen

**WARRANTY**

- FREE LIFETIME Tech Support!
- Lifetime warranty on heat platen
- 5-year warranty on frame
- 3-year warranty on controller
- 1 year warranty on parts

**SPECS**

- Weight: 76 Lbs
- Electrical: 1200W / 10A / 110V
- Shipping Dims: 24"L x 20"W x 21"H
- (add \$35 for 220V international)



**GKDK25S**  
20" x 25" Swing-Away Press  
Stand sold Separately

**FEATURES**

- Fully digital temperature control 32°-600°F range
- Automatic digital timer & dual pre-press timer
- 70 Programmable presets
- Solid steel welded framework
- Interchangeable tables
- SuperCoil-Microwinding™ heater technology
- Accommodates materials up to 1" thick
- Temperature readout accuracy +/-2°F - can show °C or °F
- User selectable end-of-cycle alarms
- Records number of pressing cycles done

**WARRANTY**

- FREE LIFETIME Tech Support!
- Lifetime warranty on heat platen
- 5 year warranty on frame
- 3 year warranty on controller
- 1 year warranty on parts

**SPECS**

- Weight: 440 Lbs
- Electrical: 4500W / 21A / 220V(only)
- Dimensions: 36"D x 36"W x 48"H

All George Knight Heat Press Products will be drop shipped F.O.B. Massachusetts. No Free Freight Available. Visit [www.heatpress.com](http://www.heatpress.com) for more detailed product information.

Heat Presses & Supplies



DBRLS SC



## Geo Knight & Co, Inc. Heat Presses & Supplies



**GKDK20S**  
16" x 20" Swing-Away Press

### FEATURES

- All-Thread™ table loading design
- Fully digital temperature control 32°-600°F range
- Automatic digital timer & dual pre-press timer
- Digital Pressure Bar Graph
- 70 Programmable presets
- Solid steel welded framework
- Instantly interchangeable & rotatable tables
- SuperCoil-Microwinding™ heater technology
- Accommodates materials up to 2" thick
- Temperature readout accuracy +/-2°F - can show °C or °F
- User selectable end-of-cycle alarms
- Records number of pressing cycles done
- Teflon-coated 3/4" thick heat platen

### WARRANTY

- FREE LIFETIME Tech Support!
- Lifetime warranty on heat platen
- 5 year warranty on frame
- 3 year warranty on controller
- 1 year warranty on parts

### SPECS

- Weight: 200 Lbs
- Electrical: 1800W / 15A / 120V
- Dimensions: 40"D x 18"W x 16"H
- (add \$35 for 220V international)

### GKDKASTAND

Universal Heat Press Stand for:

- GKDK20S
- GKDK20SP
- GKDC16
- GKDC16AP
- GKDK20
- GKDK16

### SPECS:

- Solid steel welded framework
- Lockable rolling casters
- Weight: 77 Lbs
- Shipped Dimensions: 26"D x 16"W x 8"H
- Assembled Dimensions: 36"D x 24"W x 29"H



**GKDK20SP**  
16" x 20" Digital Knight Air Automatic

### FEATURES

- Fully digital temperature control 32°-600°F range
- Automatic digital timer & dual pre-press timer
- Air regulator and gauge 20-100 PSI range (compressor req)
- Total applied force of 3000 lbs max
- 70 Programmable presets
- Solid steel welded framework
- Interchangeable tables
- SuperCoil-Microwinding™ heater technology
- Accommodates materials up to 2" thick
- Temperature readout accuracy +/-2°F - can show °C or °F
- User selectable end-of-cycle alarms
- Records number of pressing cycles done
- Teflon-coated 3/4" thick heat platen

### WARRANTY

- FREE LIFETIME Tech Support!
- Lifetime warranty on heat platen
- 5 year warranty on frame
- 3 year warranty on controller
- 1 year warranty on parts

### SPECS

- Air Compressor Required (min): 7gal, 1cfm, 100psi, 1/4" line
- Weight: 220 Lbs
- Electrical: 1800W / 15A / 120V
- Dimensions: 32"D x 27"W x 18"H
- (add \$35 for 220V international)

All George Knight Heat Press Products will be drop shipped F.O.B. Massachusetts. No Free Freight Available. Visit [www.heatpress.com](http://www.heatpress.com) for more detailed product information.

Heat Presses & Supplies

# Geo Knight & Co, Inc. Heat Presses & Supplies



DBRLS SC



**GKDK8**  
6" x 8" Label Press

**FEATURES**

- Fully digital temperature control (32°-600°F range)
- Automatic digital timer & dual pre-press timer
- 70 Programmable presets
- Hardened high-strength pivot points
- Solid steel framework
- **6" x 8", 3" x 5", 3" x 3" interchangeable tables included**
- Self lifting gas-spring & wide opening
- Temperature readout accuracy of ±2°F -- Can show °C or °F
- User selectable end-of-cycle alarms
- Records number of pressing cycles done
- Non-stick-coated 3/4" thick heat platen

**WARRANTY**

- FREE LIFETIME Tech Support!
- Lifetime warranty on heat platen
- 5 year warranty on frame
- 3 year warranty on controller
- 1 year warranty on parts

**SPECS**

- Weight: 65 Lbs
- Electrical: 600W / 5A / 110V
- Shipping Dimensions: 19"L x 12"W x 18"H
- (add \$35 for 220V international)



**GKDK7**  
4" x 7" Cap Press

**FEATURES**

- Fully digital temperature control 32°-600°F range
- Automatic digital timer & dual pre-press timer
- 70 Programmable presets
- Hardened high-strength pivot points
- Solid steel framework
- **Both STANDARD \*and\* EURO (mid-sized) bottom forms included**
- Self lifting gas-spring, & wide opening
- Cap hold-down device
- Temperature readout accuracy +-2°F - can show °C or °F
- User selectable end-of-cycle alarms
- Records number of pressing cycles done
- Teflon-coated 3/4" thick heat platen

**WARRANTY**

- FREE LIFETIME Tech Support!
- Lifetime warranty on heat platen
- 5 year warranty on frame
- 3 year warranty on controller
- 1 year warranty on parts

**SPECS**

- Weight: 50 Lbs
- Electrical: 450W / 4A / 110V
- Dimensions: 19"L x 12"W x 18"H
- (add \$35 for 220V international)

**Interchangeable Tables for GKDK7**



**GKDKAYOUTH**

Small Curved Cap Form  
Size: 3" x 5"  
Case Qty: 1

All George Knight Heat Press Products will be drop shipped F.O.B. Massachusetts. No Free Freight Available. Visit [www.heatpress.com](http://www.heatpress.com) for more detailed product information.

Heat Presses & Supplies



**Geo Knight & Co, Inc. Heat Presses & Supplies**



D B R L S SC



**GKDK20**  
**16" x 20" Clamshell Press**

**FEATURES**

- All-Thread™ table loading design
- Fully digital temperature control 32°-600°F range
- Automatic digital timer & dual pre-press timer
- Digital Pressure Bar Graph
- Super-portable light machine weight - 103 lbs!
- Extreme high pressure capability
- Hardened high-strength pivot points
- Interchangeable tables
- Solid steel framework
- SuperCoil-Microwinding™ heater technology
- Self lifting gas-spring & wide opening
- Temperature readout accuracy +-2°F - can show °C or °F
- User selectable end-of-cycle alarms
- Records number of pressing cycles done
- Teflon-coated 3/4" thick heat platen

**WARRANTY**

- FREE LIFETIME Tech Support!
- Lifetime warranty on heat platen
- 5 year warranty on frame
- 3 year warranty on controller
- 1 year warranty on parts

**SPECS**

- Weight: 103 Lbs
- Electrical: 1800W / 15A / 110V
- Dimensions: 36"L x 17"W x 16"H
- (add \$35 for 220V international)



**GKDK16**  
**14" x 16" Clamshell Press**

**FEATURES**

- All-Thread™ table loading design
- Fully digital temperature control 32°-600°F range
- Automatic digital timer & dual pre-press timer
- Digital Pressure Bar Graph
- Super-portable light machine weight - 83 lbs!
- Extreme high pressure capability
- Hardened high-strength pivot points
- Interchangeable tables
- Solid steel framework
- SuperCoil-Microwinding™ heater technology
- Self-lifting gas-spring & wide opening
- Temperature readout accuracy +-2°F - can show °C or °F
- User selectable end-of-cycle alarms
- Records number of pressing cycles done
- Teflon-coated 3/4" thick heat platen

**WARRANTY**

- FREE LIFETIME Tech Support!
- Lifetime warranty on heat platen
- 5 year warranty on frame
- 3 year warranty on controller
- 1 year warranty on parts

**SPECS**

- Weight: 83 Lbs
- Electrical: 1500W / 12A / 110V
- Dimensions: 32"L x 17"W x 16"H
- (add \$35 for 220V international)

All George Knight Heat Press Products will be drop shipped F.O.B. Massachusetts. No Free Freight Available. Visit [www.heatpress.com](http://www.heatpress.com) for more detailed product information.

Heat Presses & Supplies

## Geo Knight Digital Combo Heat Presses



D B R L S SC



**GKDC16**  
14" x 16" Manual Digital Combo Swing-Away Press

**FEATURES**

- Fully digital temperature control 32°-600°F range
- Automatic digital timer & dual pre-press timer
- Digital Pressure Bar Graph
- Interchangeable Heat Platens & Tables
- Solid steel welded framework
- SuperCoil-Microwinding™ heater technology
- Accommodates materials up to 2" thick
- Temperature readout accuracy +/-2°F - can show °C or °F
- 70 Programmable presets
- Records number of pressing cycles done
- Teflon-coated 3/4" thick heat platen

**WARRANTY**

- FREE LIFETIME Tech Support!
- Lifetime warranty on heat platen
- 5 year warranty on frame
- 3 year warranty on controller
- 1 year warranty on parts

**SPECS**

- Shirt & Tile attachments included
- Weight: 135 lbs
- Electrical: 1500W / 12A / 120V
- Dimensions: 22"W x 22"D x 22"H
- (add \$35 for 220V international)



**GKDC16AP**  
14" x 16" Automatic Digital Combo Swing-Away Press

**FEATURES**

- Automatic air operated pressing
- Fully digital temperature control 32°-600°F range
- Automatic digital timer & dual pre-press timer
- Air regulator and gauge 20-100 PSI range (compressor req)
- Total applied force of 800 lbs max
- Interchangeable Heat Platens & Tables
- Solid steel welded framework
- SuperCoil-Microwinding™ heater technology
- Accommodates materials up to 2" thick
- Temperature readout accuracy +/-2°F - can show °C or °F
- 70 Programmable presets
- Records number of pressing cycles done
- Teflon-coated 3/4" thick heat platen

**WARRANTY**

- FREE LIFETIME Tech Support!
- Lifetime warranty on heat platen
- 5 year warranty on frame
- 3 year warranty on controller
- 1 year warranty on parts

**SPECS**

- Air Compressor Required (min): 5gal, .5cfm, 100psi, 1/4" line
- Weight: 140 Lbs
- Electrical: 1500W / 12A / 120V
- Dimensions: 23"L x 23"W x 23"H
- (add \$35 for 220V international)

All George Knight Heat Press Products will be drop shipped F.O.B. Massachusetts. No Free Freight Available. Visit [www.heatpress.com](http://www.heatpress.com) for more detailed product information.



DBRLS SC



# Geo Knight Digital Combo Press Attachments



For Drinkware up to 11 1/4" diameter

### GKDCMUGFULL Mug Attachment

The full wrap mug attachment for the Digital Combo uses the same exact super-robust heater band & pressure adjustment as the GKDK3. The Digital Combo press controls the temperature and serves as a timer for this instant plug-in attachment.



### GKDCPLATE Plate Attachment

The plate die platens feature quickly inter-changeable components for allowing the circular heating element to press inside ceramic plates. Also included is a template tray and pad for centering the plate.

Attachment shown installed on press.  
Press sold separately.



### GKDCCAP 4" x 7" Cap Attachment

Caps are flawlessly printed with a curved heater block and curved bottom form with a special cap stretching device. Optional interchangeable bottom forms available.

Attachment shown installed on press.  
Press sold separately.

#### Interchangeable Tables for GKDCAP



**GKDKAYOUTH**  
Small Curved Cap Form  
Size: 3" x 5"  
Case Qty: 1



**GKDKAEURO**  
Medium Curved Cap Form  
Size: 3 1/2" x 6 1/2"  
Case Qty: 1

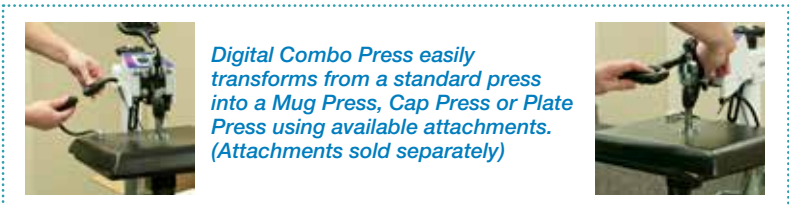

Digital Combo Press easily transforms from a standard press into a Mug Press, Cap Press or Plate Press using available attachments. (Attachments sold separately)

All George Knight Heat Press Products will be drop shipped F.O.B. Massachusetts. No Free Freight Available. Visit [www.heatpress.com](http://www.heatpress.com) for more detailed product information.

Heat Presses & Supplies



# HIX® Heat Presses



**HXSWG20**  
16" x 20" Swing-Away Press

**FEATURES**

- Full color LCD touch screen
- Heavy duty, even heating, swing-away platen
- Digital pressure readout for consistent transfer pressure
- Digital timer (adjustable up to 99 minutes 59 seconds)
- Calibrated digital temperature control (up to 450°F)
- Full adjustable pressure control
- Self leveling lower platen
- Applies transfers to items up to 1 3/4" thick

**WARRANTY**

- Lifetime warranty on heat platen
- 1 year warranty on components

**SPECS**

- Weight: 119 Lbs
- Dimensions: 33"D x 21"W x 18"H



**HXSWG25**  
20" x 25" Swing-Away Press

**FEATURES**

- Full color LCD touch screen
- Heavy duty, even heating, swing-away platen
- Digital pressure readout for consistent transfer pressure
- Digital timer (adjustable up to 99 minutes 59 seconds)
- Calibrated digital temperature control (up to 450°F)
- Full adjustable pressure control
- Self leveling lower platen
- Applies transfers to items up to 1 3/4" thick

**WARRANTY**

- Lifetime warranty on heat platen
- 1 year warranty on components

**SPECS**

- Weight: 190 Lbs
- Dimensions: 34"D x 33"W x 24"H



**HXHT400C**  
15" x 15" Clamshell Press

**FEATURES**

- Metal enclosure
- Full color LCD touch screen
- Calibrated digital temperature control up to 450°F
- Automatic digital timer
- Open/Close handle has spring assist
- Full range pressure adjustment
- ETL-US and ETL-Canada certified

**WARRANTY**

- Lifetime warranty on heat platen
- 1 year warranty on components

**SPECS**

- Weight: 84 Lbs
- Dimensions: 33"D x 21"W x 18"H



**HXHT600C**  
16" x 20" Clamshell Press

**FEATURES**

- Metal enclosure
- Full color LCD touch screen
- Calibrated digital temperature control up to 450°F
- Automatic digital timer
- Open/Close handle has spring assist
- Full range pressure adjustment
- ETL-US and ETL-Canada certified

**WARRANTY**

- Lifetime warranty on heat platen
- 1 year warranty on components

**SPECS**

- Weight: 95 Lbs
- Dimensions: 33"D x 21"W x 18"H

All HIX® Heat Presses will be drop shipped F.O.B. Kansas. No Free Freight Available.

\*Heat Presses are not combinable for free freight with standard stock orders under \$500.

Heat Presses & Supplies



DBRLS SC

**INSTA**  
INSTA GRAPHIC SYSTEMS

INSTA Presses feature interchangeable bottom platens.

## INSTA Graphic Systems Manual Heat Presses



**INSTA256**  
16" x 20" Swing-Away Press

**FEATURES**

- Quick-Change™ Interchangeable Accessory Platens
- Integrated digital controller which features controls for time, temperature (F or C) & auto-off
- Full dressability front and back
- One-piece ergonomic wrap-around stainless steel handle

**WARRANTY**

- Lifetime warranty on heat platen
- 1 year warranty on parts
- 90 days on labor

**SPECS**

- Weight: 121 Lbs
- Dimensions: 40"D x 32"W x 22"H
- Electrical: 1750W / 14.6A / 120V

*All Insta Heat Presses will be drop shipped F.O.B. California. No Free Freight Available.*



**INSTA288**  
20" x 25" Swing-Away Press

**FEATURES**

- H-frame and lightweight construction
- Quick-Change™ Interchangeable Accessory Platens
- Integrated digital controller which features controls for time, temperature (F or C) & auto-off
- Full dressability front and back
- One-piece ergonomic wrap-around stainless steel handle

**WARRANTY**

- Lifetime warranty on heat platen
- 1 year warranty on parts
- 90 days on labor

**SPECS**

- Weight: 200 Lbs
- Dimensions: 49"D x 39"W x 22"H
- Electrical: 3300W / 14.4A / 230V

Heat Presses & Supplies

**NEW** **HOTRONIX® Heat Presses**



D B R L S SC

**STAHL'S**  
**Hotronix®**



**XF**  
**Fusion IQ®**  
**16" x 20"**

Functioning as either a swing-away or draw press, the 16" x 20" Fusion IQ offers a heat-free workspace, touch screen settings and live digital time, temperature and pressure readouts. Plus, with industry-exclusive Threadability™, you can position a garment once, rotate, and decorate any area.

**FEATURES**

- New Fusion IQ™ controller features troubleshooting and self-diagnostic capabilities
- Optional quick-change lower platens, no tools required
- Touch Screen Technology: program an unlimited number of frequently used application settings
- Production cycle counter, auto on/off settings, and eight optional language settings
- Program up to four different pressure and time settings
- Track performance and print productivity reports from anywhere with the new Hotronix online portal
- Electrical Options: 120 v; 15 amps; 1800 w / 240 v; 7.5 amps; 1800 w
- Must have dedicated circuit breaker

**WARRANTY**

- Heating Element - Lifetime
- Framework - 5 years
- Circuit Board - 2 years
- Parts & Labor - 1 year

**SPECS**

- Actual weight: 137 lbs
- Ship weight: 150 lbs
- Ship dim. 37" x 25" x 24"

Heat Presses & Supplies



**STXCP**  
**360 IQ® Hat Press**  
**6" x 5"**

The innovative 360° print area lets you print the front, back, and sides of a cap without removing it from the press.

**FEATURES**

- Molded platen to reduce creasing and scorching
- One-size-fits-all platen - transition between cap sizes without having to change platens
- Independently controlled upper and lower heated platens
- Heated lower platen makes it easy to apply patches and emblems
- Wide opening offers a heat-free workspace
- Opens automatically, reducing risk of over-application
- Digital time, temperature, and pressure display
- Electrical Options: 120 v; 10 amps; 800 w / 240 v; 5 amps; 800 w
- Must have dedicated circuit breaker

**WARRANTY**

- Heating Element - Lifetime
- Framework - 5 years
- Circuit Board - 2 years
- Parts & Labor - 1 year

**SPECS**

- Actual weight: 44 lbs
- Ship weight: 50 lbs
- Ship dim. 26" x 15" x 24"

All Hotronix® Heat Presses  
will be drop shipped  
F.O.B. Pennsylvania  
No Free Freight Available.



**NEW** **HOTRONIX® Heat Presses**



D B R L S SC

**STAHL'S®**  
**Hotronix®**



**XRF2**  
**Dual Air Fusion IQ®**  
**16" x 20" Dual Platen Press**

With two heat platen stations, this heat press increases efficiency by allowing threading and layout on one station while the other is being pressed. It's perfect for high-volume operations and for DTG applications.

**FEATURES**

- New Fusion IQ™ controller with larger, higher-resolution screen, plus troubleshooting and self-diagnostic capabilities
- Program each station to work independently or in unison with Position-Based Recipe printing
- Full Threadability™ on lower platens: position the garment, rotate, and decorate any area
- Auto Adjust Pressure™: Set four different time and pressure settings that adjust automatically for your recipe
- Exclusive Auto-Adjust Pressure™ automatically adjusts to the thickness of the item being printed
- Digital time, temperature, and pressure readouts
- Operates in full-auto, semi-auto, or manual modes
- Touchscreen stores frequently used settings, production cycle counter, and auto on/off capability
- 120 PSI for heavy-pressure application
- Requires air compressor (not included) with minimum: **1 horsepower and 8-gallon hold tank. Uses 3.8 CFM**
- 240 v; 15 amps; 3500 w
- Must have dedicated circuit breaker

**WARRANTY**

- Heating Element - Lifetime
- Framework - 5 years
- Circuit Board - 2 years
- Parts & Labor - 1 year

**SPECS**

- Actual weight: 260 lbs
- Ship weight: 410 lbs
- Ship dim. 45" x 45" x 35"



**XRF**  
**Air Fusion IQ®**  
**16" x 20" Swing-Away Press**

Perfect for high-volume shops, specialty decorators, and Direct-to-Garment applications, the air-powered Air Fusion IQ heat press features a 16" x 20" heated upper platen and swing motion, for a heat-free workspace. Available in tabletop or adjustable-height pedestal stand models.

**FEATURES**

- New Fusion IQ™ controller features troubleshooting and self-diagnostic capabilities
- Track performance and print productivity reports from anywhere with the new Hotronix Online Portal
- New larger, higher resolution screen with improved touchscreen response
- Exclusive Auto-Adjust Pressure™ automatically adjusts to the thickness of the item being printed
- Full Threadability™ on the lower platen: position the garment, rotate, and decorate any area
- Auto open, auto swing design, with a foot pedal reduces fatigue
- Touchscreen stores frequently used settings, production cycle counter, and auto on/off capability
- 120 PSI for high-pressure applications
- Optional quick-change platens; no tools required
- Optional Platens: 7" Round, 6" x 10", 8" x 10" & 11" x 15"
- Program up to four different pressure and time settings
- Requires air compressor (not included) with minimum: **½ horsepower and 2.5-gallon hold tank. Uses 2.3 CFM**
- Electrical Options: 120 v; 15 amps; 1800 w / 240 v; 7.5 amps; 1800 w
- Must have dedicated circuit breaker

**WARRANTY**

- Heating Element - Lifetime
- Framework - 5 years
- Circuit Board - 2 years
- Parts & Labor - 1 year

**SPECS**

- Actual weight: 152 lbs
- Ship weight: 245 lbs
- Ship dim. 40" x 48" x 58"



**XRF-TT**  
**Table Top Air Fusion IQ®**  
**16" x 20" Swing-Away Press**

For Features & Warranty, refer to information listed above.

**SPECS**

- Actual weight: 126 lbs
- Ship weight: 180 lbs
- Ship dim. 37" x 24" x 24"

All Hotronix® Heat Presses will be drop shipped F.O.B. Pennsylvania. No Free Freight Available.

Heat Presses & Supplies

**NEW** **HOTRONIX® Heat Presses**

**Auto Open Clam**

The Auto Clam opens automatically when time is up, preventing over-application and scorching, and allowing you to focus on more than one job at once.

**FEATURES**

- Easy-to read digital time, temperature, and pressure display for accurate, consistent printing
- Over-the-Center Pressure Adjustment for even, edge-to-edge heat and pressure, regardless of substrate thickness
- Wide opening for easy layout
- Space-saving clamshell design
- Patented magnetic auto-open feature prevents over-application
- Locks down easily with patented magnetic assist, causing less fatigue on wrists and shoulders
- Twin Timer™ allows user to pre-set individual time settings for two-step application or for pre-heating and application
- Optional interchangeable lower platens available
- 11" x 15" Electrical Options: 120 v; 8.3 amps; 1000 w / 240 v; 4.5 amps; 1000 w
- 16" x 16", 16" x 20" Electrical Options: 120 v; 15 amps; 1800 w / 240 v; 7.5 amps; 1800 w
- Must have dedicated circuit breaker

**WARRANTY**

- Heating Element - Lifetime
- Framework - 5 years
- Circuit Board - 2 years
- Parts & Labor - 1 year

**SPECS**

- Actual weight: 59-87 lbs
- Ship weight: 72-100 lbs
- Ship dim. 36" x 25" x 21"



**DBRLS SC**

**STAHL'S  
Hotronix®**



**STX20**  
16" x 20"



**STX16**  
16" x 16"



**STX11**  
11" x 15"

**STX20H  
Hover**  
16" x 20"

With two modes — hover for curing or press for application — the 16" x 20" Hotronix Hover heat press is great for DTG and screen printing operations, as well as heat transfer applications.

**FEATURES**

- Hover mode cures DTG designs without smearing ink
- Opens automatically to prevent over-application
- Space-saving clamshell design
- Easy-to read digital time, temperature, and pressure readouts
- 3/4" flotation upper heat platen
- Optional Platens: 7" Round, 6" x 10", 8" x 10" & 11" x 15"
- Interchangeable lower platens available in a variety of sizes (sold separately)
- Twin Timer™ allows user to pre-set individual time settings for two-step application or for pre-heating and application
- Locks down easily with patented magnetic assist, causing less fatigue on wrists and shoulders
- Over-the-Center Pressure Adjustment for even, edge-to-edge heat and pressure regardless of substrate thickness
- Electrical Options: 120 v; 15 amps; 1800 w / 240 v; 7.5 amps; 1800 w
- Must have dedicated circuit breaker

**WARRANTY**

- Heating Element - Lifetime
- Framework - 5 years
- Circuit Board - 2 years
- Parts & Labor - 1 year

**SPECS**

- Actual weight: 87 lbs
- Ship weight 100 lbs
- Ship dim. 36" x 25" x 21"



All Hotronix® Heat Presses  
will be drop shipped  
F.O.B. Pennsylvania  
No Free Freight Available.

Heat Presses & Supplies

**NEW** **HOTRONIX® Heat Presses**



D B R L S SC

**STAHL'S**  
**Hotronix®**



**STXC**  
**Auto Cap**  
**3 1/2" x 6"**

Spur add-on sales and decorate the whole uniform with this easy-to-use cap heat press, designed to decorate caps of all sizes.

**FEATURES**

- Patented magnetic auto-open feature prevents over-application
- Hold-down device secures cap and creates a smooth surface
- Decorate head wear of all shapes, styles, and sizes with available optional platens
- Easy-to-read digital time, temperature, and pressure display for consistent printing
- Locks down easily with patented magnetic assist, causing less fatigue on wrists and shoulders
- Twin Timer™ allows user to pre-set individual time settings for two-step application or for pre-heating and application
- Under-the-Center Pressure Adjustment ensures even, edge-to-edge heat and pressure
- Optional Platens: 2 3/4" x 6 1/2", 3" x 5 3/4", 4" x 6 1/2" & 4" x 8"
- Space saving clam shell design
- Electrical Options: 120 v; 4 amps; 500 w / 240 v; 2 amps; 500 w
- Must have dedicated circuit breaker

**WARRANTY**

- Heating Element - Lifetime
- Framework - 5 years
- Circuit Board - 2 years
- Parts & Labor - 1 year

**SPECS**

- Actual weight: 30 lbs
- Ship weight: 41 lbs
- Ship dim. 26" x 15" x 21"



**STX6L**  
**LowRider**  
**6" x 6"**

Heat apply collar labels, small patches, and other small designs with this compact heat press. Lightweight and portable for mobile heat-application opportunities.

**FEATURES**

- Patented magnetic auto-open feature prevents over-application
- Easy-to-read digital time, temperature, and pressure display for consistent printing
- Space-saving clam shell design
- Locks down easily with patented magnetic assist, causing less fatigue on wrists and shoulders
- Twin Timer™ allows user to pre-set individual time settings for two-step application or for pre-heating and application
- Over-the-Center Pressure Adjustment for even, edge-to-edge heat and pressure regardless of the substrate thickness
- Platens included: 6" x 6", 4" round, 6" x 1 7/8" x 5 7/8" (Y shaped)
- Electrical Options: 120 v; 3 amps; 360 w / 240 v; 1.5 amps; 360 w
- Must have dedicated circuit breaker

**WARRANTY**

- Heating Element - Lifetime
- Framework - 5 years
- Circuit Board - 2 years
- Parts & Labor - 1 year

**SPECS**

- Actual weight: 28 lbs
- Ship weight: 41 lbs
- Ship dim. 26" x 15" x 21"

All Hotronix® Heat Presses will be drop shipped F.O.B. Pennsylvania No Free Freight Available.

Heat Presses & Supplies





## MAXX® Heat Presses

### Maxx Clam

This affordable, easy-to-use heat press is perfect for start-ups or home-based businesses. It's also an excellent choice as a second heat press, and portable for on-site heat applications.

#### FEATURES

- Three sizes available 16" x 20", 15" x 15", 11" x 15"
- Easy-to-read digital time and temperature display for consistent printing
- Wide opening for easy layout
- Space saving clam shell design
- Patented Over-the-Center Pressure Adjustment for even, edge-to-edge heat and pressure regardless of substrate thickness
- Smooth-shock opening
- Coated non-stick heat platen
- Optional interchangeable lower platens available
- 11" x 15" Electrical Options: 120 v; 8.3 amps; 1000 w / 240 v; 4.5 amps; 1000 w
- 15" x 15", 16" x 20" Electrical Options: 120 v; 15 amps; 1800 w / 240 v; 7.5 amps; 1800 w
- Must have dedicated circuit breaker

#### WARRANTY

- Heating Element - Lifetime
- Parts & Labor - 1 year

#### SPECS

- Actual weight: 59-87 lbs
- Ship weight: 72-104 lbs
- Ship dim. 36" x 25" x 21"

### MAXXC MAXX Cap

This affordable, easy-to-use cap heat press is great for decorators getting into heat pressing caps and hats. With a 3.5" x 6" platen, it can be used with a wide variety of caps and is lightweight and portable. Great for mobile heat assisted operations.

#### FEATURES

- Hold down device secures cap and creates a smooth surface
- Easy-to-read digital time and temperature display for consistent printing
- Optional interchangeable platens available to help print headwear of any shape, style, and size
- Optional Platens: 3" x 5 3/4", 2 3/4" x 6 1/2", 4" x 6 1/2" & 4" x 8"
- Under-the-Center Pressure Adjustment ensures even, edge-to-edge heat and pressure
- Coated non-stick heat platen
- Smooth-shock opening
- Electrical Options: 120 v; 4 amps; 500 w / 240 v; 2 amps; 500 w
- Must have dedicated circuit breaker

#### WARRANTY

- Heating Element - Lifetime
- Parts & Labor - 1 year

#### SPECS

- Actual weight: 30 lbs
- Ship weight: 40 lbs
- Ship dim. 26" x 15" x 21"



DBRLS SC

STAHL'S  
Hotronix®

MAXX20  
16" x 20"



MAXX15  
15" x 15"



MAXX11  
11" x 15"



All Hotronix® Heat Presses  
will be drop shipped  
F.O.B. Pennsylvania  
No Free Freight Available.

**NEW** HOTRONIX® Platen & Accessories



DBRLS SC

STAHL'S  
HOTRONIX®



**Power Platens & Accessories**

Reduce the risk of scorching on heat-sensitive fabrics with this innovative heated lower platen.

Power Platens & Accessories	Part Number
16" x 20" Power Platen	LHP20
11" x 15" Power Platen	LHP11
6" x 6" Power Platen	LHP6
6" x 20" Power Platen Sleeve/Leg	LHPLS

Requires the Power Platen Controller (sold separately)  
Not compatible with the Hotronix Fusion IQTM or draw presses.

**LHPF  
Power Platen Family**

Includes all the above individual products. The Power Controller Housing, 16" x 20" Power Platen, 11" x 15" Power Platen, 6" x 6" Power Platen, 6" x 20" Power Platen Sleeve/Leg.

**LHPC  
Power Platen Control Housing**

Power Platen Control Housing is needed for any of the individual platens to work. You only need one controller, any of the individual platens can plug into it.

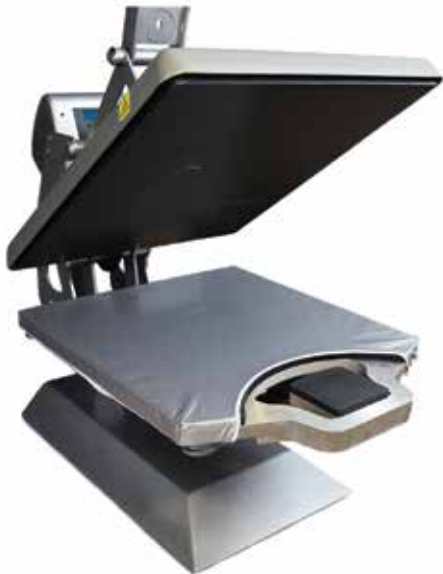

**PLTAGA  
Tag Along™ HP Platen**

The Tag Along™ HP Platen, a patented design of Livingston Systems, allows you to thread your garment onto the platen and apply a full front and tagless label in one simple step. Works with select 16" x 20" heat presses.

**FEATURES**

- Design helps load shirts straight
- 16" x 15" full front print area
- 3 1/4" x 3 1/4" tag print area

**SPECS**

- Actual weight: 20 lbs
- Ship weight: 23 lbs
- Ship dim. 26" x 20" x 5"

Must be used with a threadable heat press.

All Hotronix® Heat Presses  
will be drop shipped  
F.O.B. Pennsylvania  
No Free Freight Available.

Heat Presses & Supplies



**Quick Change Platens**

Description	Part Number
4" x 4" - for small garments & accessories	PL4X4
7" Round - for duffle bags	PL7R
8" x 10" - for tote bags	PL8X10
6" x 10" - for left chest & hoodie pockets	PL6X10
11" x 15" - for women & children's apparel	PL11X15
Best Value - Set of 3 (7" round, 8" x 10", 6" x 10")	PLSET3
16" x 20" Double Sleeve/Leg Platen - for long slender items	PLDLS
6" x 20" Fusion Sleeve/Leg Platen - for long slender items	PLLS
6" x 15" Shoe Platen - for athletic footwear	PLSHOE
Can Cooler Platen - for 8 collapsible coolers	PLCAN
Hat Bill Platen - for underside or top	PLHBILL
Baby Cap Platen - Size: 2 1/2" x 3"	PLCAP2X3
Standard Cap Platen - Size: 3 1/2" x 6"	PLCAP3X6
A2Z - for left chest & hoodie pockets, Size: 6" x 10"	PL6X10-A2Z
6" x 6" Lower Platen	PL6X6

**CHOOSING THE RIGHT PLATEN FOR YOUR JOB**

Heat Presses & Supplies

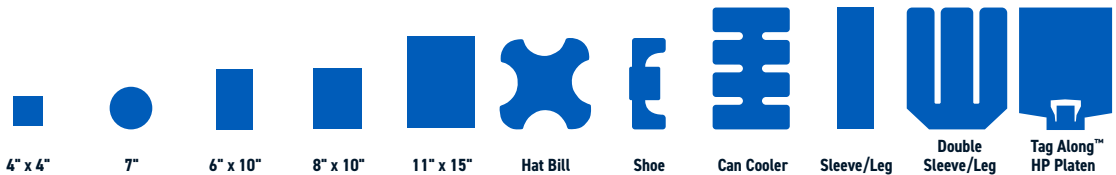

	4" x 4"	7"	6" x 10"	8" x 10"	11" x 15"	Hat Bill	Shoe	Can Cooler	Sleeve/Leg	Double Sleeve/Leg	Tag Along™ HP Platen
<b>DUAL AIR FUSION IQ®</b>	✓	✓	✓	✓	✓	✓	✓	✓	✓	✓	✓
<b>AIR FUSION IQ®</b>	✓	✓	✓	✓	✓	✓	✓	✓	✓	✓	✓
<b>FUSION IQ®</b>	✓	✓	✓	✓	✓	✓	✓	✓	✓	✓	✓
<b>HOVER PRESS™ (16" x 20")</b>	✓	✓	✓	✓	✓	✓	✓	✓	✓	✓	✓
<b>AUTO OPEN CLAM (16" x 20")</b>	✓	✓	✓	✓	✓	✓	✓	✓	✓	✓	✓
<b>AUTO OPEN CLAM (16" x 16")</b>	✓	✓	✓	✓	✓	✓	✓				
<b>AUTO OPEN CLAM (11" x 15")</b>	✓	✓	✓	✓	✓	✓	✓				
<b>THE MAXX® CLAM (16" x 20")</b>	✓	✓	✓	✓	✓	✓	✓	✓		✓	✓
<b>THE MAXX® CLAM (15" x 15")</b>	✓	✓	✓	✓	✓	✓	✓				
<b>THE MAXX® CLAM (11" x 15")</b>	✓	✓	✓	✓	✓	✓	✓				
<b>BEST FOR:</b>	Youth apparel and accessories with seams, zippers and buttons.	Gym bags and items requiring a round print surface.	Youth apparel and smaller items.	Items that require a smaller surface.	Youth or smaller women's apparel. Also great for longer names and designs.	Underside or top of a hat bill.	Shoes with a printable area of 2" x 4".	Up to eight can coolers.	Sleeves, legs, and other long, slender items. Also used for oversized billboard prints.	Faster decoration of two sleeves or legs at a time.	Quickly applying shirt fronts and tagless labels at the same time.



**NEW** **HOTRONIX® Platen Accessories**

D B R L S SC

STAHL'S  
**Hotronix®**



**Interchangeable Cap Platens**



Interchangeable Cap Platens	Part Number	Size
<b>All Star</b>	<b>PLCAP2X6</b>	2 3/4" x 6 1/2"
<b>Rookie</b>	<b>PLCAP3X5</b>	3" x 5 3/4"
<b>Slugger</b>	<b>PLCAP4X6</b>	4" x 6 1/2"
<b>Champ</b>	<b>PLCAP4X8</b>	4" x 8"
<b>Best Value - Set of 4 (1 each)</b>	<b>PLCAPS4</b>	1 of each size

Only to be used with Auto Cap and Maxx Cap heat presses, not the 360 IQ Hat press

**Platen Covers**

Increase the life and productivity of your heat press. Our Quick Slip pad protectors reduce wear and tear on the lower platen of your heat press and make garment placement quicker and easier.

**Quick Slip Lower Platen Protectors**

Part Number	Size
<b>1-2375</b>	6" x 10"
<b>1-2374</b>	8" x 10"
<b>1-2153</b>	11" x 15"
<b>1-2154</b>	15" x 15"
<b>1-2155</b>	16" x 16"
<b>1-2156</b>	16" x 20"
<b>1-2465</b>	7" round
<b>1-2378</b>	6" x 20"



**Upper Platen Covers**

Part Number	Size
<b>1-2180</b>	16" x 20"

**Silicone Upper Platen Cover**

Part Number	Size
<b>1-2334</b>	16" x 20"



All Hotronix® Heat Presses will be drop shipped F.O.B. Pennsylvania No Free Freight Available.

Heat Presses & Supplies



**KIT3-1298**  
**Laser Alignment System**

The Laser alignment system is designed to increase efficiency when decorating apparel. Use the 4 lasers to show exactly where the logo or design needs to be placed. Set up is easy with the Layout Alignment Wizard™. Turn on the lasers, place the wizard on the lower platen and manually adjust the lasers to match the lines. Perfect placement every time.

- 4 individual lasers are flexible and can be aligned manually.
- Compatible with any heat press, including Hotronix or MAXX.
- Layout Alignment Wizard is included.
- 3 Ft. electrical cord with A/C adaptor is included.
- Requires 18-inch table space.

**1-2310-2**  
**Heat Press Caddie Stand**

Heat Press Caddie gives the ability to add industry-exclusive Threadability™ to any Hotronix® Auto Open Clam, Hover press, or MAXX® Clam heat press. This stand is not compatible with the Fusion IQ.

**SPECS**

- Size: 32" x 32" x 34" - 39"
- Weight: 61 lbs

**1-2410-1**  
**Heat Press Counter Caddie**

This countertop version of our Heat Press Caddie sits on a flat work surface. It adds industry-exclusive Threadability™ to any Hotronix® Auto Open Clam, Hover press, or MAXX® Clam heat press. This stand is not compatible with the Fusion IQ.

**SPECS**

- Size: 22" x 12" x 6"
- Table Height: 30" Recommended
- Weight: 26 lbs

**1-2364**  
**Printing Equipment Cart**

Adjustable, portable cart for a heat press, vinyl cutter, laser cutter, or DTG. It can also double as an extra layout table.

- Heavy duty steel cart.
- Crank raises the cart to a maximum height of 35" or lowers to 17".
- Comes fully assembled.
- Holds up to 600 lbs.
- Casters allow the cart to be moved

**SPECS**

- Table top: 37.6"L x 24"W x 17.3"H
- Adjustable Height from: 17" to 35"
- Actual weight: 122 lbs.
- Ship weight: 126lbs.
- Ship dim. 38.2" x 24.8" x 18.11"

*All Hotronix® Heat Presses  
will be drop shipped  
F.O.B. Pennsylvania  
No Free Freight Available.*



**NEW** HOTRONIX® Accessories

D B R L S SC

**STAHL'S**  
**Hotronix®**



**WT-1000-110**  
**Stahls' EZ Weeding Table**

The Stahls' EZ Weeding™ Table warms heat transfer vinyl, saving an average of 60% weeding time.

**DIMENSIONS**

- 39"L x 27 1/2"W x 4"H (Closed)
- 39"L x 27 1/2"W x 17"H (Open)
- Shipping dimensions: 31" x 43" x 8"
- Weight: 27 lbs



**CLWP-STAHLS**  
**CAD-CUT Weeding Panel**

This lightweight, portable panel heats to 130° F to soften your heat transfer vinyl's adhesive and make weeding easier. Its low cost and sturdy construction make it a valuable tool for any shop. Includes mini adhesive pads to keep panel stable.

**SPECS**

- Size: 16" x 22"
- Weight: 9 lbs

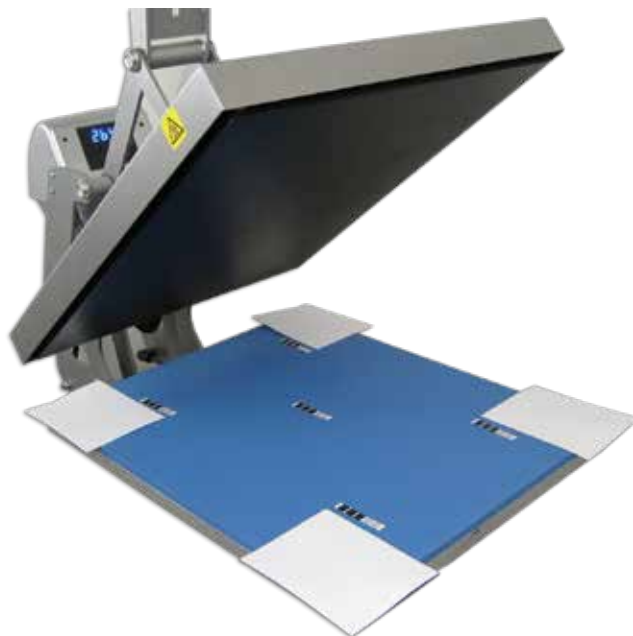

**TK-STAHLS**  
**Heat Seal Machine Test Kit**

The leading cause for ruined garments is a heat press with cold spots. This test kit makes sure your heat press has accurate temperature.

- Includes 5 strips
- Designed to check temperature accuracy of your heat press machine

*All Hotronix® Heat Presses  
will be drop shipped  
F.O.B. Pennsylvania  
No Free Freight Available.*

Heat Presses & Supplies





**Cover Sheets**  
**TSL-STAHLS**  
**Reusable Cover Sheet**

Size: 18" x 20" x 6 mil

This reusable cover sheet leaves a smooth semi-gloss finish on heat transfer materials.

**KP1620**  
**Kraft Paper**

(25 pack)

Size: 16" x 20"

Protect the upper platen of your heat press and leave a matte finish on heat transfer material.



**Heat Press Pillows**

The right heat press accessories allow you to offer more hard-to-decorate items. Heat Press Pillows raise the print area around thick seams, zippers, and pockets to ensure even pressure and perfect application every time.

Made with a 3/4" foam pad inside a non-stick Teflon cover for easily sliding in and out of items, Heat Press Pillows are the perfect alternative if Threadability™ isn't an option. They come in a variety of sizes great for heat pressing sleeves, legs, hoodies, youth, and women's apparel.

Part Number	Size
<b>TPS-STAHLS</b>	6" x 8"
<b>TPY-STAHLS</b>	10" x 10"
<b>TPL-STAHLS</b>	5" x 18"
<b>TPD-STAHLS</b>	12" x 14"
<b>TP-STAHLS</b>	16" x 20"



**Print Perfect Pads\***

Print perfect pads have a similar purpose as heat printing pillows but work differently. While heat printing pillows allow the zippers and seams to depress into the pillow, print perfect pads actually raise the printing area to work around these elements. They are also the recommended accessory for screen printed or digital transfers because they maintain even pressure.

Part Number	Size
<b>KIT3-1315</b>	8" x 10"
<b>KIT3-1316</b>	5" x 6"
<b>KIT3-1319</b>	3 1/2" x 15"



**RP22-STAHLS**  
**Flexible Application Pad**

Size: 18" x 22"



**Foam Cover Pads\***



Part Number	Size
<b>1-2581</b>	4" x 8" x 1/8"
<b>1-2583</b>	4" x 8" x 1/4"
<b>1-2657</b>	16" x 20" x 1/8"

*\*All Hotronix® Heat Presses will be drop shipped F.O.B. Pennsylvania. No Free Freight Available.*

**NEW** **HOTRONIX® Accessories**

D B R L S SC

**STAHL'S**  
**Hotronix®**



**EZW-STAHLS**  
**Easy Weeder**

The EZ Weeder® makes it easy to weed detailed design cavities from heat transfer materials and printable heat transfer materials.



**HE-STAHLS**  
**Heat Eraser**

Cool your designs faster with a heat eraser. Great tool to use when you're working with cold peel materials.



**T-STAHLS**  
**Thermo Tape™**

Size: 3/8" x 72 yd

Use this heat resistant tape to keep graphics and lettering in place before and during heat press application.



**TH-STAHLS**  
**Thermo Tape™ Dispenser**

Slip resistant dispenser with a rubber base.

Heat Presses & Supplies

# Heat Press Supplies

Case Qty: 1

DBRLSSC



**JDSTEF1416**  
Non-Stick Sheet  
Size: 14" x 16"



**JDSTEF1620**  
Non-Stick Sheet  
Size: 16" x 20"

*Sheets to protect your heat press.*



**GKTEF1416**  
Teflon® Sheet  
Size: 14" x 16" 



**GKTEF1620**  
Teflon® Sheet  
Size: 16" x 20" 



**GKTEFW1416**  
Teflon® Bottom  
Table Wrap  
Size: 14" x 16" 



**GKTEFW1620**  
Teflon® Bottom  
Table Wrap  
Size: 16" x 20" 

Heat Press Supplies



# Heat Press Supplies

D B R L S SC

Case Qty: 1



**GKHCR18510**  
Heat Conductive Pad  
Size: 1/8" x 5" x 9 7/8"



**GKHCR181416**  
Heat Conductive Pad  
Size: 1/8" x 14" x 16"



**THERM1620**  
Heat Conductive Pad  
Size: 1/16" x 16" x 20"

### Heat-Conductive Pads

Also called thermal pads or heating pads, heat-conductive pads help aid in the even contact between the transfer and the substrate. When cut to the appropriate size, this material can also be used as a wrap for water bottles and other unconventional shaped items sublimated in a convection oven.



**GKNOM1416**  
White Nomex Pad  
Size: 1/2" x 14" x 16"



**GKNOM1620**  
White Nomex Pad  
Size: 1/2" x 16" x 20"



**FELT1620**  
Felt Pad  
Size: 1/8" x 16" x 20"

Heat Press Supplies



DBRLS SC

## Corner Shaper & Dies

Can be used on metal and plastic engraving stock.

Case Qty: 1

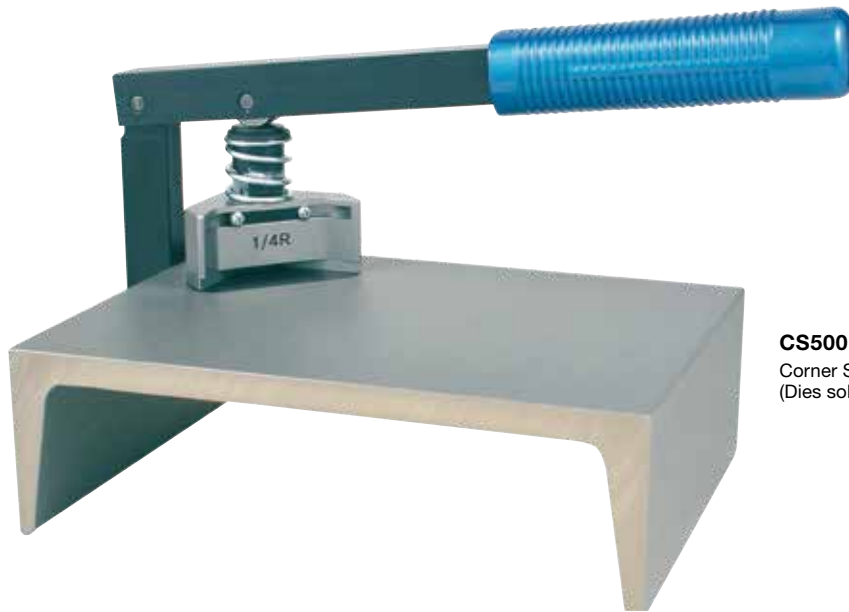

### Specifications

Dimensions: 9½" L x 6" W x 4½" H  
 Weight: 4 lbs.  
 Material: Aluminum  
 Max. Stock Thickness:  
 Brass - 0.030"  
 Aluminum - 0.045"  
 Steel - 0.015"  
 Plastic - 0.063"

### CS500

Corner Shaper Platform.  
 (Dies sold separately)

Engraving Supplies

### Die Shapes and Sizes



Radius Dies	Notch Dies	Decorative Dies	Scallop Dies	Slot Punch	Hole Punch
<b>DR18</b> 1/8" Radius	<b>DN18</b> 1/8" Notch			<b>SP20</b> Slot is 1/8" x 9/16"	<b>HP20</b> Hole diameter is 3/32"
<b>DR316</b> 3/16" Radius					<b>HP20A</b> Hole diameter is 1/8"
<b>DR14</b> 1/4" Radius	<b>DN14</b> 1/4" Notch		<b>DSC14</b> 1/4" Scallop		
<b>DR38</b> 3/8" Radius	<b>DN38</b> 3/8" Notch	<b>DD38</b> 3/8" Decorative	<b>DSC38</b> 3/8" Scallop		
<b>DR12</b> 1/2" Radius		<b>DD12</b> 1/2" Decorative			

Switching between plastic & metal blades on shear is not recommended due to the time it takes to change & re-square blades.

**Cutter Resharpener Service** (allow 2-3 weeks)  
 For standard cutters, burnishers and profiler tools. JDS cannot sharpen diamond tools.  
 Send tools to: JDS Industries, 1800 E 57th St N., Sioux Falls, SD 57104



D B R L S SC

## Plastic 12" Shear/Metal 12" Shear

12" Table Shear available for either plastic or metal. Blades are specifically designed to cut metal only or plastic only.

Case Qty: 1

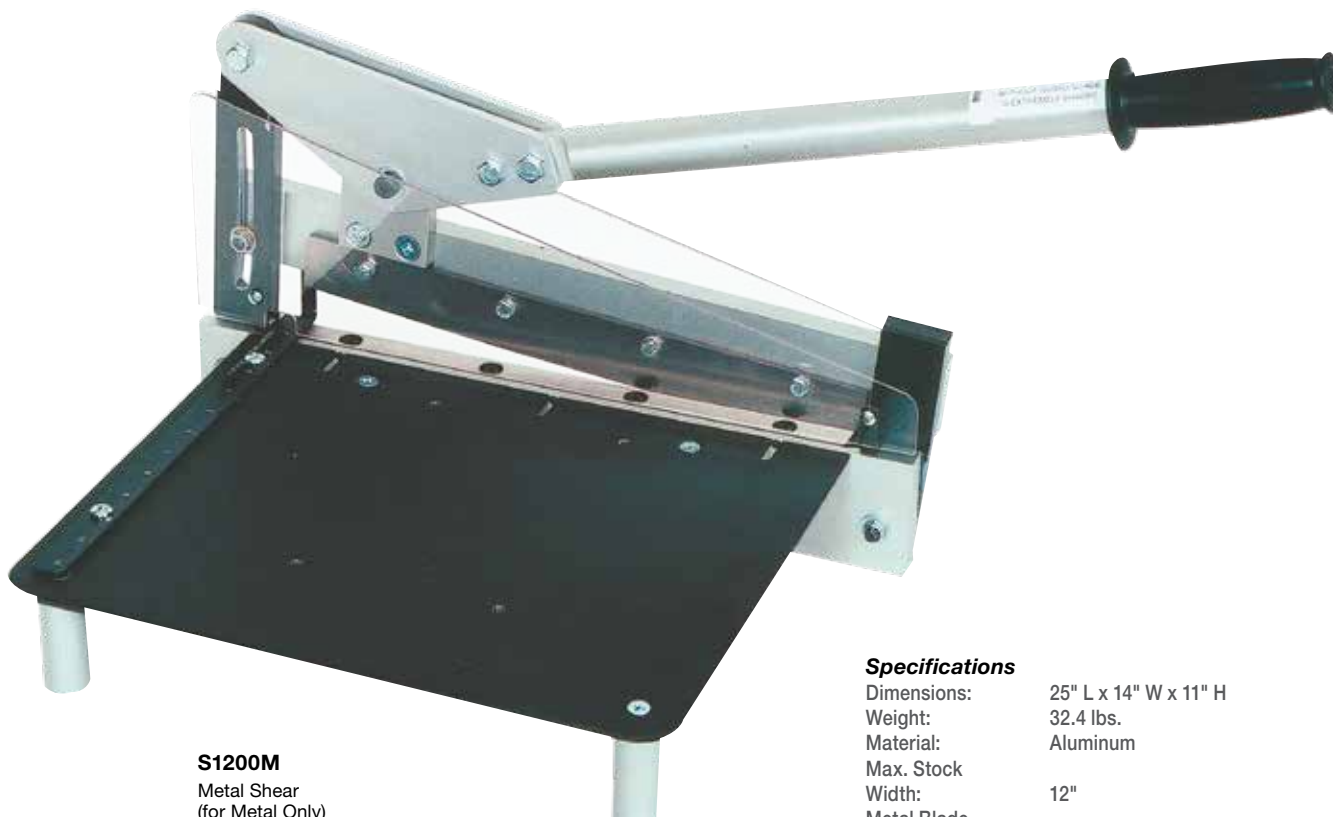

**S1200M**  
Metal Shear  
(for Metal Only)

**S1200P**  
Plastic Shear  
(for Plastic Only)

### Specifications

Dimensions:	25" L x 14" W x 11" H
Weight:	32.4 lbs.
Material:	Aluminum
Max. Stock	
Width:	12"
Metal Blade	
Cutting Capacity:	Brass up to .025" Aluminum up to .050" Steel up to .025"
Plastic Blade	
Cutting Capacity:	Flexible Plastic up to .063"

### Replacement Blade Sets:

**BLADEM**  
Metal cutting blade

**BLADEP**  
Plastic cutting blade

**S1200SCALE**  
12" Replacement  
Scale/Ruler

Switching between plastic & metal blades on shear is not recommended due to the time it takes to change & re-square blades.

**Cutter Resharpener Service** (allow 2-3 weeks)  
For standard cutters, burnishers and profiler tools. JDS cannot sharpen diamond tools.  
Send tools to: JDS Industries, 1800 E 57th St N., Sioux Falls, SD 57104

Engraving Supplies

**SEP102** 24X48  
WHT/RED SATIN ENGRV 1/16

**SEP103** 24X48  
WHT/BLU SATIN ENGRV 1/16

SEP 102  
WHT/RED SATIN ENGRV 1/16

SEP 106  
WHT/BLU SATIN ENGRV 1/16



# Materials & Substrates

*if you're looking for:*

**JDS PLASTICS**

**DUETS® PLASTIC STOCK**

**DUETS® ACCENTS™ ACRYLICS**

**BRAILLE BEADS**

**DUETS® TACTILES ADA & APPLIQUE**

**DUETS® INDOOR & OUTDOOR SHEET STOCK**

**BADGE SETS, FINDINGS & MAGNETS**

## JDS Laserable Plastic

Engraving Depth: **.003"**  
 Full Sheet: **24" x 49"**  
 Use: **Interior/  
 Exterior**

UV-Resistant acrylic based laminate for both indoor and outdoor use. Benefiting from a thin top layer, it enables detailed engraving at high production speeds. Superior composition minimizes residue and reduces the need for cleaning.

**DBRLSSC**

**FREE SAMPLE SET #LPLSET1**  
 Includes a 4" x 4" piece of each. 13 pieces total.

### 1/16" Thick: Gloss & Matte Non-Glare

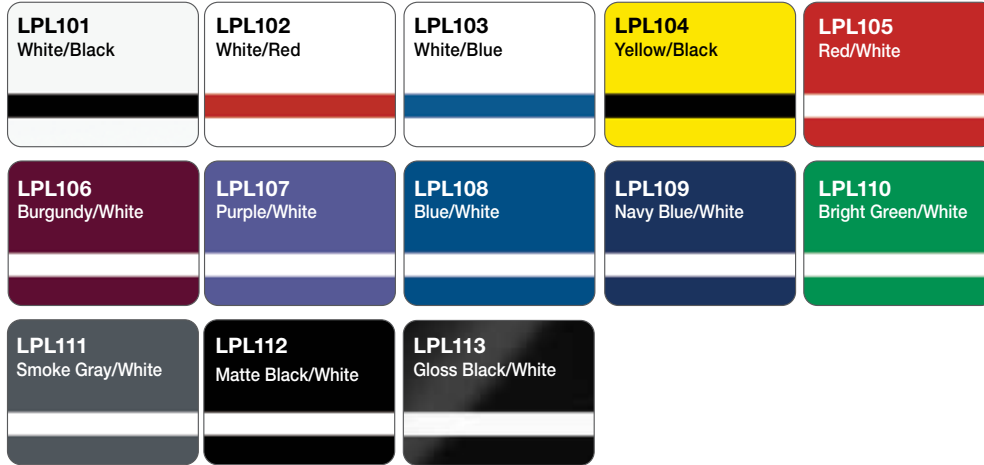

Plastic Sheet Stock

## JDS Satin Rotary Engravable Plastic

Engraving Depth: **.012"**  
 Full Sheet: **24" x 48"**  
 Use: **Interior**

Interior laminate with an extensive color range. Suited for internal signage, nameplates, key tags and personal identification. The solid cap offers a durable and scratch resistant surface.

**DBRLSSC**

**FREE SAMPLE SET #SEPSET1**  
 Includes a 4" x 4" piece of each. 12 pieces total.

### 1/16" Thick: Gloss-Brushed

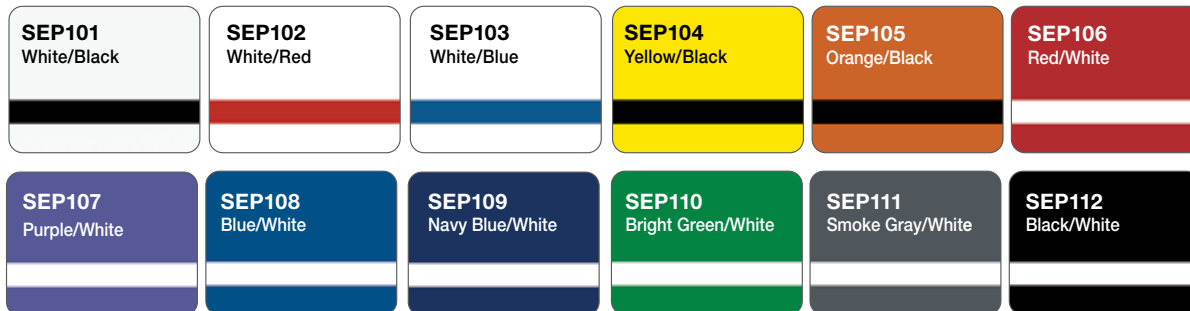

**AP** AP Customers get best price when ordering any 10 quarter sheets, 10 half sheets or 5 full sheets of plastic sheet stock.

**IMPORTANT:**

Add "Q" for quarter sheet (12" x 24") or "H" for half sheet (24" x 24") to the end of the part number when ordering. Part number as listed indicates "Full" sheet.

# JDS Print Receptive Plastic

**D B R L S SC**

**Engraving Depth:** .003" (except PRP101 & PRP102)  
**Full Sheet:** 24" x 49"  
**Use:** Interior

Impact modified acrylic pretreated for superior ink adhesion. Developed for printing with UV & LED curing inks. The core material is made of impact modified acrylic which makes it printable and laserable.

**FREE SAMPLE SET #PRPSET1**  
 Includes a 4" x 4" piece of each. 8 pieces total.

## 1/16" Thick: Gloss, Matte & Mirrored

<b>PRP101</b> Gloss White ABS core	<b>PRP102</b> Matte White ABS core	<b>PRP103</b> Matte White/Black	<b>PRP104</b> Gloss White/Black
<b>PRP105</b> Brushed Aluminum/ Black	<b>PRP106</b> Satin Brass/Black	<b>PRP107</b> Mirrored Silver/Black	<b>PRP108</b> Mirrored Gold/ Black



**AP** AP Customers get best price when ordering any 10 quarter sheets, 10 half sheets or 5 full sheets of plastic sheet stock.

**IMPORTANT:**  
 Add "Q" for quarter sheet (12" x 24") or "H" for half sheet (24" x 24") to the end of the part number when ordering. Part number as listed indicates "Full" sheet.

Plastic Sheet Stock



**D B R L S SC**

## Duets® Selects Laser Sheet Stock Single Pass Laser

**Engraving Depth:** .003"  
**Full Sheet:** 24" x 49"  
**Use:** Interior/Exterior  
**Material:** Microsurfaced Impact Modified Acrylic

The sheet quality and superior flatness of Duets® Selects offers improved productivity with the advantage of single pass laser cutting or rotary engraving. A go-to solution for applications ranging from highly-detailed signage and wayfinding applications, to name badges, industrial applications and awards. Available in both non-glare matte or satin finishes to deliver the look you want with the speed you need.



**Applications:**  
 Architectural Signage  
 Egress / Exit Signage  
 Exterior Signage  
 Interior Signage  
 Industrial Signage  
 Personal Identification  
 Safety Signage  
 Trophies, Awards, & Plaques  
 Wayfinding

**Characteristics:**  
 Front engravable  
 Outdoor/indoor  
 UV stable outdoor/indoor  
 UV-LED Printable

**Capabilities:**  
 Scores  
 Shears  
 Saws  
 Drills  
 Laser Vector Cuts  
 Bevels  
 Heat Bendable  
 Screen Prints  
 Hot Stamps  
 Fine Engraving  
 Bonds  
 UV Stable  
 CNC Routes

### 1/16" Brushed Satin

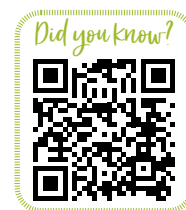

### 1/16" Matte (Non-Glare)



**IMPORTANT:**

Add "Q" for quarter sheet (12" x 24") or "H" for half sheet (24" x 24") to the end of the part number when ordering. Part number as listed indicates "Full" sheet.

**AP** AP Customers get best price when ordering any 10 quarter sheets, 10 half sheets or 5 full sheets of plastic sheet stock.

**Duets Sample Swatch Binder:**

Purchase a Duets® Swatch Binder. Item #**DBINDER**  
 Contact us for **FREE** binder swatch replacements.



Plastic Sheet Stock





D B R L S SC

## Duets® Textures Laser Sheet Stock High Traffic

Engraving Depth: .012  
 Full Sheet: 24" x 49"  
 Use: Interior/Exterior  
 Material: Microsurfaced Impact Modified Acrylic

Designed especially for the durability demands of high-touch environments, the lightly textured finish of Duets® Textures is engineered to resist the appearance of fingerprints, offer detailed engraving and extreme durability. Ideal for public spaces, high-traffic retail and industrial environments, Duets Textures is the perfect material for rugged outdoor or indoor signage and tagging applications.



**Applications:**  
 Architectural Signage  
 Egress / Exit Signage  
 Exterior Signage  
 Interior Signage  
 Industrial Signage  
 Personal Identification  
 Safety Signage  
 Trophies, Awards, & Plaques  
 Wayfinding

**Characteristics:**  
 Front engravable  
 Outdoor/indoor  
 UV stable outdoor/indoor  
 UV-LED Printable

**Capabilities:**  
 Scores  
 Shears  
 Saws  
 Drills  
 Laser Vector Cuts  
 Bevels  
 Heat Bendable  
 Screen Prints  
 Hot Stamps  
 Fine Engraving  
 Bonds  
 UV Stable  
 CNC Routes

### 1/16" Textures

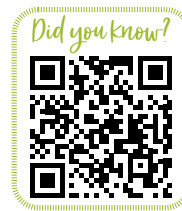
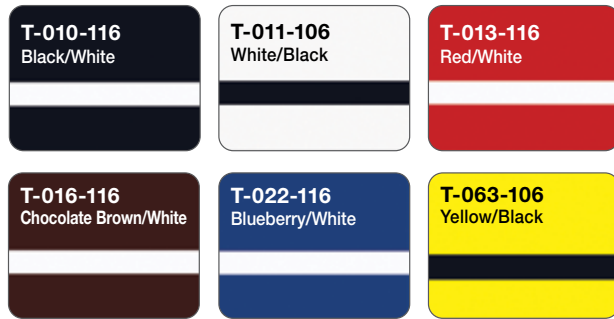

### 1/8" Textures

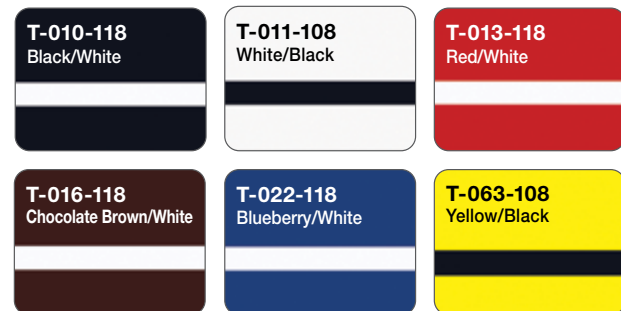

### Fabrication Services

- sublimation
- engraving
- lasering
- sandcarving
- color printing
- cnc routing
- signage

855.537.2228

art@jdsindustries.com

see pages 9-10 for more info

**IMPORTANT:**

Add "Q" for quarter sheet (12" x 24") or "H" for half sheet (24" x 24") to the end of the part number when ordering. Part number as listed indicates "Full" sheet.

**AP** AP Customers get best price when ordering any 10 quarter sheets, 10 half sheets or 5 full sheets of plastic sheet stock.

**Duets Sample Swatch Binder:**

Purchase a Duets® Swatch Binder.

Item #**DBINDER**

Contact us for **FREE** binder swatch replacements.



Plastic Sheet Stock



**DBRLS**

## Duets Ultimates® Sheet Stock Maximum Durability

Engraving Depth: **.012"**  
 Full Sheet: **24" x 49"**  
 Use: **Interior/Exterior**  
 Material: **Microsurfaced Impact Modified Acrylic**

A beautiful touch in the toughest of environments. Duets Ultimates is a co-extruded impact modified acrylic which is UV stable and suitable for interior and exterior applications. The heavy-duty top layer offers increased abrasion resistance and damage protection making Duets Ultimates the material of choice for harsh environments.



**Applications:**  
 ADA Signage  
 Architectural Signage  
 Egress / Exit Signage  
 Exterior Signage  
 Interior Signage  
 Industrial Signage  
 Personal Identification  
 Safety Signage  
 Trophies, Awards, & Plaques  
 Wayfinding

**Characteristics:**  
 ADA Compliant  
 Reverse engravable  
 Outdoor/indoor  
 UV stable outdoor/indoor  
 UV-LED Printable

**Capabilities:**  
 Scores  
 Shears  
 Saws  
 Drills  
 Laser Vector Cuts  
 Bevels  
 Heat Bendable  
 Screen Prints  
 Hot Stamps  
 Fine Engraving  
 Bonds  
 UV Stable  
 CNC Routes

### 1/16" Ultimates



### 1/8" Ultimates

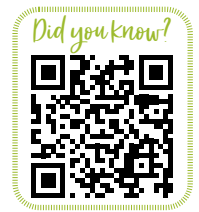

**IMPORTANT:**

Add "Q" for quarter sheet (12" x 24") or "H" for half sheet (24" x 24") to the end of the part number when ordering. Part number as listed indicates "Full" sheet.

**AP** AP Customers get best price when ordering any 10 quarter sheets, 10 half sheets or 5 full sheets of plastic sheet stock.

**Duets Sample Swatch Binder:**

Purchase a Duets® Swatch Binder. Item #**DBINDER**  
 Contact us for **FREE** binder swatch replacements.



Plastic Sheet Stock



DBRLS SC

## Duets Ultimates® Sheet Stock Maximum Durability

Engraving Depth: .012"  
 Full Sheet: 24" x 49"  
 Use: Interior/Exterior  
 Material: Microsurfaced Impact Modified Acrylic

A beautiful touch in the toughest of environments. Duets Ultimates is a co-extruded impact modified acrylic which is UV stable and suitable for interior and exterior applications. The heavy-duty top layer offers increased abrasion resistance and damage protection making Duets Ultimates the material of choice for harsh environments.



**Applications:**  
 ADA Signage  
 Architectural Signage  
 Egress / Exit Signage  
 Exterior Signage  
 Interior Signage  
 Industrial Signage  
 Personal Identification  
 Safety Signage  
 Trophies, Awards, & Plaques  
 Wayfinding

**Characteristics:**  
 ADA Compliant  
 Reverse engravable  
 Outdoor/indoor  
 UV stable outdoor/indoor  
 UV-LED Printable

**Capabilities:**  
 Scores  
 Shears  
 Saws  
 Drills  
 Laser Vector Cuts  
 Bevels  
 Heat Bendable  
 Screen Prints  
 Hot Stamps  
 Fine Engraving  
 Bonds  
 UV Stable  
 CNC Routes

### 1/8" 3 Ply Ultimates



drop ship  
ONLY

Plastic Sheet Stock

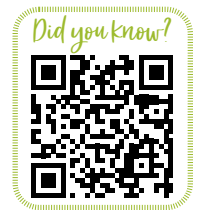

**IMPORTANT:**  
 Add "Q" for quarter sheet (12" x 24") or "H" for half sheet (24" x 24") to the end of the part number when ordering. Part number as listed indicates "Full" sheet.

AP Customers get best price when ordering any 10 quarter sheets, 10 half sheets or 5 full sheets of plastic sheet stock.

**Duets Sample Swatch Binder:**  
 Purchase a Duets® Swatch Binder.  
 Item #DBINDER  
 Contact us for FREE binder swatch replacements.



# Duets Ultimates® Reverse Sheet Stock Reverse with Durability



**D B R L S SC**

**Engraving Depth:** .012"  
**Full Sheet:** 24" x 49"  
**Use:** Interior/Exterior  
**Material:** Microsurfaced Impact Modified Acrylic

With its clear, matte-finish top layer, Duets Ultimates® Reverse is the UV stable reverse engraving material for smooth-finish, non-glare signage, ADA and labeling solutions that stand up to punishment of any environment. Expand the applications for your signage with the added value of multi-color paint fills or backlighting effects. Base colors correspond with our Duets Ultimates substrate for a complete solution.



**Applications:**

- Architectural Signage
- Egress / Exit Signage
- Exterior Signage
- Interior Signage
- Industrial Signage
- Personal Identification
- Safety Signage
- Trophies, Awards, & Plaques
- Wayfinding

**Characteristics:**

- Front engravable
- Outdoor/indoor
- UV stable outdoor/indoor
- UV-LED Printable

**Capabilities:**

- Scores
- Shears
- Saws
- Drills
- Laser Vector Cuts
- Bevels
- Heat Bendable
- Screen Prints
- Hot Stamps
- Fine Engraving
- Bonds
- UV Stable
- CNC Routes

## 1/16" Matte (Non-Glare)

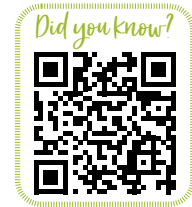
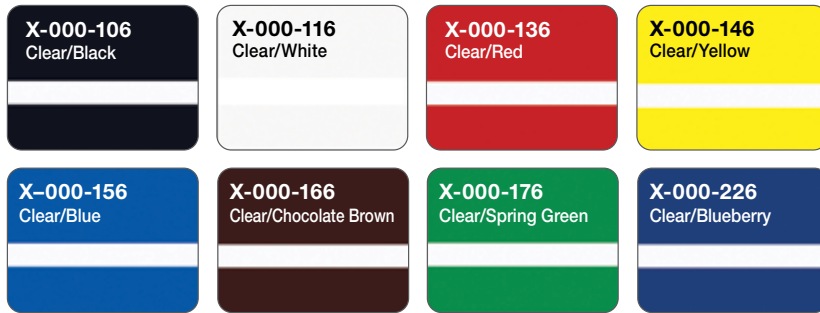

## \*1/8" Matte (Non-Glare)

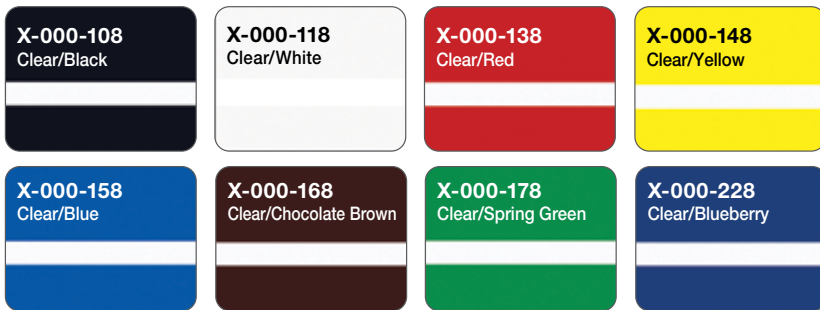

**drop ship  
ONLY**

**IMPORTANT:**

Add "Q" for quarter sheet (12" x 24") or "H" for half sheet (24" x 24") to the end of the part number when ordering. Part number as listed indicates "Full" sheet.

**AP** AP Customers get best price when ordering any 10 quarter sheets, 10 half sheets or 5 full sheets of plastic sheet stock.

**Duets Sample Swatch Binder:**

Purchase a Duets® Swatch Binder. Item #**DBINDER**. Contact us for **FREE** binder swatch replacements.



Plastic Sheet Stock





D B R L S SC



## Duets® Laser XT Reverse Sheet Stock

Engraving Depth: .003"  
 Full Sheet: 24" x 49"  
 Use: Interior/ Exterior  
 Material: Microsurfaced Impact Modified Acrylic

Make a statement with this sturdy 2-ply engraving substrate. The clear top layer has a matte finish, and the vividly-colored back layer is reverse engraved. Backlight or back paint this outdoor-grade material to give a whole new dimension to wayfinding, branding or displays.

**Applications:**  
 ADA Signage  
 Architectural Signage  
 Egress / Exit Signage  
 Exterior Signage  
 Interior Signage  
 Industrial Signage  
 Personal Identification  
 Safety Signage  
 Trophies, Awards, & Plaques  
 Wayfinding

**Characteristics:**  
 ADA Compliant  
 Reverse engravable  
 Outdoor/indoor  
 UV stable (\*except Gold & Silver)  
 UV-LED Printable

**Capabilities:**  
 Saws  
 Laser Vector Cuts  
 Bevels  
 Screen Prints  
 Hot Stamps  
 Fine Engraving  
 Bonds  
 UV Stable\*  
 CNC Routes

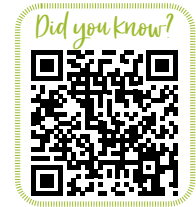

### 1/16" Thick Matte (Non-Glare) - For interior & exterior use.



### 1/16" Thick Matte (Non-Glare) - For interior use only.



(\*Gold and Silver are not UV stable)

Plastic Sheet Stock

### Fabrication Services

- sublimation
- engraving
- lasering
- sandcarving
- color printing
- cnc routing
- signage

855.537.2228

art@jdsindustries.com

see pages 9-10 for more info

**SPECIAL ORDER**

1/8" Also available by special order.

**IMPORTANT:**

Add "Q" for quarter sheet (12" x 24") or "H" for half sheet (24" x 24") to the end of the part number when ordering. Part number as listed indicates "Full" sheet.



AP Customers get best price when ordering any 10 quarter sheets, 10 half sheets or 5 full sheets of plastic sheet stock.

**Duets Sample Swatch Binder:**

Purchase a Duets® Swatch Binder. Item #DBINDER  
 Contact us for **FREE** binder swatch replacements.



## Duets® Accents™ Acrylic Sheet Stock Enhanced Style

Transparent, translucent and solid color substrates for aesthetic decor. Duets Accents® is single-ply, cell-cast acrylic sheet material offered in both a range of transparent, translucent and opaque colors. Duets Accents offer a wide range of versatility, with contemporary architectural colors, a combination of gloss and matte finishes, and can be easily paired with Duets® Tactiles™ to create a tactile sign with the look you want.



**D B R L S SC**



STOCKING

**Applications:**

- ADA Signage
- Architectural Signage
- Exterior Signage
- Interior Signage
- Industrial Signage
- Trophies, Awards, & Plaques
- Wayfinding

**Characteristics:**

- ADA Compliant
- Front engravable
- Reverse engravable
- Outdoor/indoor
- UV stable outdoor/indoor
- UV Printable (Direct Color Systems Endorsed)

**Capabilities:**

- Saws
- Drills
- Laser Vector Cuts
- Bevels
- Heat Bendable
- Screen Prints
- Hot Stamps
- Bonds
- Laser Engraves
- CNC Routes



**Transparent colors: gloss finish on both sides**

L-020-028 L-020-029 Clear Glass Transparent	1/8" 1/4"	L-020-058 Green Glass Transparent	1/8"	L-020-068 Topaz Glass Transparent	1/8"
--	--------------	---	------	---	------

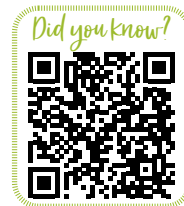

**Translucent colors: matte (non-gloss) finish one side / gloss finish one side**

L-020-008 L-020-009 Matte Glass Translucent	1/8" 1/4"	L-020-808 Ice Translucent	1/8"	L-020-848 French Blue Translucent	1/8"	L-020-818 Citrine Translucent	1/8"
L-020-878 Amethyst Translucent	1/8"	L-020-888 Poppy Translucent	1/8"	L-020-838 Turquoise Translucent	1/8"	L-020-898 Smoke Translucent	1/8"



**Solid colors: matte (non-gloss) finish one side / gloss finish one side**

L-020-118 L-020-119 Polar White Solid Color	1/8" 1/4"	L-020-108 L-020-109 Jet Black Solid Color	1/8" 1/4"	L-020-138 Crimson Solid Color	1/8"	L-020-158 Royal Blue Solid Color	1/8"	L-020-478 Everest Grey Solid Color	1/8"
---	--------------	---	--------------	----------------------------------	------	-------------------------------------	------	--	------

**IMPORTANT:**

Add "Q" for quarter sheet (12" x 24") or "H" for half sheet (24" x 24") to the end of the part number when ordering. Part number as listed indicates "Full" sheet.

**Duets Sample Swatch Binder:**

Purchase a Duets® Swatch Binder. Item #**DBINDER**  
Contact us for **FREE** binder swatch replacements.



Plastic Sheet Stock



DBRLS SC



STOCKING PARTNER

## Braille Beads

Braille Beads for ADA signage. For use with Accent software and braille pen or universal tool. Contact Accent for more information.

Case Qty: 1



**DBB03J10K**  
Clear  
Qty: 10,000



**DBB10J10K**  
Black  
Qty: 10,000



**DBB65J10K**  
Grey  
Qty: 10,000



**DBB11J10K**  
White  
Qty: 10,000



**DBB90J05K**  
Stainless Steel  
Qty: 5,000



Braille Beads



**D B R L S C**

# Duets Tactiles® ADA & Applique Sheet Stock

**Full Sheet: 24" x 49"**  
**Use: Interior/Exterior**  
**Material: Impact Modified Acrylic**

ADA wayfinding and appliqué engraving is a vital segment of any sign making business. Choose from dozens of modern colors to match any interior or exterior décor for your ADA, appliqué and braille signs.



## Matte (Non-Glare)

L-010-033-A* 1/32" L-010-033 1/32" L-010-036 1/16" L-010-038 1/8" Clear/Matte	L-010-303-A* 1/32" L-010-306 1/16" L-010-308 1/8" Bright White	L-010-583-A* 1/32" L-010-586 1/16" L-010-588 1/8" Frost	L-010-113-A* 1/32" L-010-116 1/16" L-010-118 1/8" White	L-010-563-A* 1/32" L-010-566 1/16" L-010-568 1/8" Warm White	L-010-143-A* 1/32" L-010-146 1/16" L-010-148 1/8" Yellow
L-010-673-A* 1/32" L-010-676 1/16" L-010-678 1/8" Metallic Gold	L-010-123-A* 1/32" L-010-126 1/16" L-010-128 1/8" Gold	L-010-623-A* 1/32" L-010-626 1/16" L-010-628 1/8" Orange	L-010-423-A* 1/32" L-010-426 1/16" L-010-428 1/8" Medieval Copper	L-010-533-A* 1/32" L-010-536 1/16" L-010-538 1/8" Pipestone	L-010-133-A* 1/32" L-010-136 1/16" L-010-138 1/8" Red
L-010-543-A* 1/32" L-010-546 1/16" L-010-548 1/8" Burgundy	L-010-523-A* 1/32" L-010-526 1/16" L-010-528 1/8" Merlot	L-010-513-A* 1/32" L-010-516 1/16" L-010-518 1/8" Pink	L-010-373-A* 1/32" L-010-376 1/16" L-010-378 1/8" Light Blue	L-010-363-A* 1/32" L-010-366 1/16" L-010-368 1/8" Periwinkle	L-010-493-A* 1/32" L-010-496 1/16" L-010-498 1/8" Slate Blue
L-010-153-A* 1/32" L-010-156 1/16" L-010-158 1/8" Blue	L-010-573-A* 1/32" L-010-576 1/16" L-010-578 1/8" Cobalt Blue	L-010-403-A* 1/32" L-010-406 1/16" L-010-408 1/8" Majestic Blue	L-010-353-A* 1/32" L-010-356 1/16" L-010-358 1/8" Denim Blue	L-010-433-A* 1/32" L-010-436 1/16" L-010-438 1/8" Spruce	L-010-463-A* 1/32" L-010-466 1/16" L-010-468 1/8" Lagoon
L-010-453-A* 1/32" L-010-456 1/16" L-010-458 1/8" Intense Teal	L-010-443-A* 1/32" L-010-446 1/16" L-010-448 1/8" Mint	L-010-173-A* 1/32" L-010-176 1/16" L-010-178 1/8" Spring Green	L-010-183-A* 1/32" L-010-186 1/16" L-010-188 1/8" Evergreen	L-010-323-A* 1/32" L-010-326 1/16" L-010-328 1/8" Bisque	L-010-203-A* 1/32" L-010-206 1/16" L-010-208 1/8" Almond
L-010-313-A* 1/32" L-010-316 1/16" L-010-318 1/8" Bone	L-010-263-A* 1/32" L-010-266 1/16" L-010-268 1/8" Khaki	L-010-343-A* 1/32" L-010-346 1/16" L-010-348 1/8" French Vanilla	L-010-383-A* 1/32" L-010-386 1/16" L-010-388 1/8" Desert Sand	L-010-603-A* 1/32" L-010-606 1/16" L-010-608 1/8" Putty	L-010-333-A* 1/32" L-010-336 1/16" L-010-338 1/8" Latte
L-010-393-A* 1/32" L-010-396 1/16" L-010-398 1/8" Taupe	L-010-593-A* 1/32" L-010-596 1/16" L-010-598 1/8" Aged Bronze	L-010-613-A* 1/32" L-010-616 1/16" L-010-618 1/8" Chestnut	L-010-163-A* 1/32" L-010-166 1/16" L-010-168 1/8" Chocolate Brown	L-010-653-A* 1/32" L-010-656 1/16" L-010-658 1/8" Grey	L-010-473-A* 1/32" L-010-476 1/16" L-010-478 1/8" Light Grey
L-010-193-A* 1/32" L-010-196 1/16" L-010-198 1/8" Silver	L-010-483-A* 1/32" L-010-486 1/16" L-010-488 1/8" Oyster Shell	L-010-503-A* 1/32" L-010-506 1/16" L-010-508 1/8" River Clay	L-010-413-A* 1/32" L-010-416 1/16" L-010-418 1/8" Frosted Plum	L-010-293-A* 1/32" L-010-296 1/16" L-010-298 1/8" Charcoal Grey	L-010-553-A* 1/32" L-010-556 1/16" L-010-558 1/8" Graphite
L-010-103-A* 1/32" L-010-106 1/16" L-010-108 1/8" Black	<p><b>3M A*</b> – Indicates item with 3M adhesive backing.</p>				

**IMPORTANT:**  
 Add "Q" for quarter sheet (12" x 24") or "H" for half sheet (24" x 24") to the end of the part number when ordering. Part number as listed indicates "Full" sheet.

**AP** AP Customers get best price when ordering any 10 quarter sheets, 10 half sheets or 5 full sheets of plastic sheet stock.

Plastic Sheet Stock





DBRLSSC

# Duets Tactiles® ADA & Applique Sheet Stock

**Applications:**

- ADA Signage
- Architectural Signage
- Egress / Exit Signage
- Exterior Signage
- Interior Signage
- Industrial Signage
- Personal Identification
- Safety Signage
- Wayfinding

**Characteristics:**

- ADA Compliant
- Outdoor/indoor
- UV stable outdoor/indoor
- UV Printable (Direct Color)
- Systems Endorsed)

**Capabilities:**

- Scores\*\*
- Shears\*\*
- Saws
- Drills
- Laser Vector Cuts
- Bevels
- Heat Bendable
- Screen Prints
- Hot Stamps
- Bonds
- UV stable\*
- Laser Engraves
- CNC Routes



**Matte (Non-Glare) - Value Adhesive (With Orafol® adhesive backing)**

L-010-103-A2 1/32" Black	L-010-113-A2 1/32" White	L-010-303-A2 1/32" Bright White	L-010-133-A2 1/32" Red
L-010-153-A2 1/32" Blue	L-010-293-A2 1/32" Charcoal Grey	L-010-163-A2 1/32" Chocolate Brown	L-010-473-A2 1/32" Light Grey
L-010-203-A2 1/32" Almond	L-010-193-A2 1/32" Silver	A2 – Indicates item with Orafol® adhesive backing.	

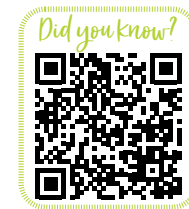

Duets Tactiles are made from a multi-layer impactmodified acrylic sheet. This new Duets Tactiles material uses photoluminescent acrylic to glow in the dark, making wayfinding and directional signage highly visible regardless of light conditions.

**Glow**

L-010-993-A*	1/32"
L-010-993	1/32"
L-010-996	1/16"
L-010-998	1/8"
Glow	

- ADA-compliant for sign-making applications
- UL-1994 Certified for emergency exits and directional markings
- Visible during power outages and other low-light conditions
- Charges via ambient light – no batteries or electricity required
- Ships with protective masking and UL Compliance guidelines for sign making
- Assists in LEED® qualification



**3M** A\* – Indicates item with 3M adhesive backing.



**Duets Sample Swatch Binder:**

Purchase a Duets® Swatch Binder. Item #DBINDER  
Contact us for **FREE** binder swatch replacements.

**SPECIAL ORDER**

1/32" is also available without adhesive by special order.  
1/16" & 1/8" are available with adhesive by special order.



UL: 1994:2015 Ed. 4, Clauses 33 and 34

New York City (NYC) Local Law 141

**Try it FREE**

- **FREE** swatch chips and test samples
- **FREE** ADA test sample kit  
Item# FLY0617



1/8" not recommended for shearing and scoring.

Plastic Sheet Stock



## Duets® Laser Indoor Sheet Stock

Engraving Depth: .003"  
 Full Sheet: 24" x 49"  
 Use: Interior  
 Material: Microsurfaced Impact Modified Acrylic

Perfect for interior wayfinding, branding or recognition, Gemini makes consistent laser engraving substrates. They come in three thicknesses, and several finishes that model real wood, marble and metallic surfaces.



**Applications:**  
 Architectural Signage  
 Egress / Exit Signage  
 Interior Signage  
 Industrial Signage  
 Personal Identification  
 Safety Signage  
 Trophies, Awards, & Plaques  
 Wayfinding

**Characteristics:**  
 Front engravable  
 Indoor  
 UV-LED Printable

**Capabilities:**  
 Scores\*\*  
 Shears\*\*  
 Saws  
 Drills  
 Laser Vector Cuts  
 Bevels  
 Heat Bendable  
 Screen Prints  
 Hot Stamps  
 Bonds  
 Fine Engraving  
 Laser Engraves  
 CNC Routes

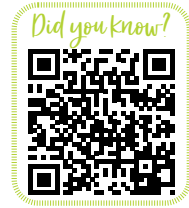

### 1/16" Thick Metals



### 1/16" Thick Woods & Marbles

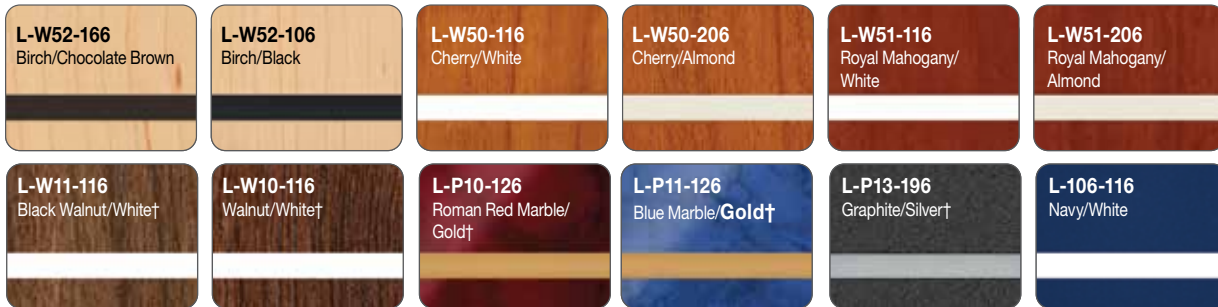

\*CG – Indicates Clear-Guard® option for smudge resistance in high traffic areas  
 † May be slightly under 24"

**SPECIAL ORDER** Custom combinations of colors available (Set up fee may apply.)  
 2-Ply, 1/16" & 1/8" by special order.

1/8" Metals are also available by special order.

**SPECIAL ORDER**

**IMPORTANT:**  
 Add "Q" for quarter sheet (12" x 24") or "H" for half sheet (24" x 24") to the end of the part number when ordering. Part number as listed indicates "Full" sheet.

**AP** AP Customers get best price when ordering any 10 quarter sheets, 10 half sheets or 5 full sheets of plastic sheet stock.

**Duets Sample Swatch Binder:**  
 Purchase a Duets® Swatch Binder. Item #DBINDER  
 Contact us for **FREE** binder swatch replacements.



Plastic Sheet Stock



DBRLSSC

## DuetsContours® Flexible Sheet Stock

Engraving Depth: **.003"**  
 Full Sheet: **24" x 49"**  
 Use: **Interior**  
 Material: **Microsurfaced Impact Modified Acrylic**

Thin but durable, the DuetsContours microsurfaced flexible engraving stock is designed to deliver the prominent look of engraved signage applied to curved surfaces. Engravable substrates are available with or without adhesive and in a number of color and finish combinations.



**Applications:**

Awards & Recognition  
 Interior Branding  
 Retail Display  
 Interior Signage  
 Trophies, Awards, & Plaques

**Characteristics:**

Indoor  
 Front engravable  
 Adhesive back options  
 Indoor Use

**Capabilities:**

Scores  
 Shears  
 Saws  
 Drills  
 Silk Screen  
 Hot Stamp  
 Bondable  
 Vector cut  
 UV-LED Printable

**.020" Thick Matte (Non-Glare) - unless otherwise noted.**



**.020" Thick Metals**

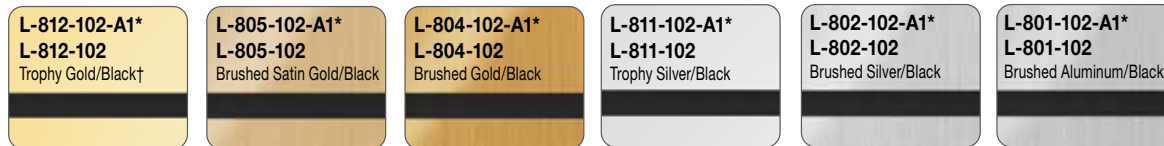

† May be slightly under 24"

Plastic Sheet Stock

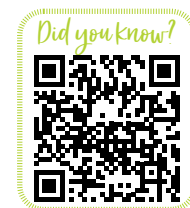

Custom combinations of colors available (Set up fee may apply.)  
 (1/8" available in 2-ply & 3-ply with black or white base color.)

**IMPORTANT:**

Add "Q" for quarter sheet (12" x 24") or "H" for half sheet (24" x 24") to the end of the part number when ordering. Part number as listed indicates "Full" sheet.

**Duets Sample Swatch Binder:**

Purchase a Duets® Swatch Binder. Item #DBINDER  
 Contact us for **FREE** binder swatch replacements.





D B R L S SC

# Duets® Laser XT Outdoor/Indoor Sheet Stock

Engraving Depth: .003"  
 Full Sheet: 24" x 49"  
 Use: Interior/Exterior  
 Material: Microsurfaced Impact Modified Acrylic

Make a powerful impression with design-forward interior or exterior signage. Quality substrates for fine engraving, yet durable enough to resist the ravages of weather and sun. Duets Laser XT is available in three thicknesses. Several colors come in a two-sided, 3-ply option.



**Applications:**  
 Architectural Signage  
 Egress / Exit Signage  
 Exterior Signage  
 Interior Signage  
 Industrial Signage  
 Personal Identification  
 Safety Signage  
 Trophies, Awards, & Plaques  
 Wayfinding

**Characteristics:**  
 Front engravable  
 Outdoor/indoor  
 UV stable outdoor/indoor  
 UV-LED Printable

**Capabilities:**  
 Scores  
 Shears  
 Saws  
 Drills  
 Laser Vector Cuts  
 Bevels  
 Heat Bendable  
 Screen Prints  
 Hot Stamps  
 Fine Engraving  
 Bonds  
 UV Stable  
 CNC Routes

**SPECIAL ORDER**

All colors available in 1/8" by special order.

Only L-100-113, L-103-113, L-111-103, L-116-103, L-104-113 available in 1/32" by special order.

Custom combinations of colors available (Set up fee may apply.)

1/8" available in 2-ply & 3-ply with black or white base color.

## 1/8" Thick Matte (Non-Glare)

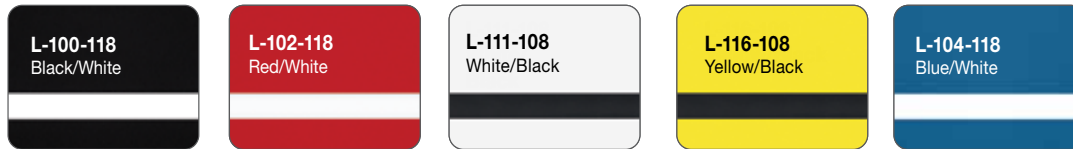

## 1/16" Thick Matte (Non-Glare) - unless otherwise noted.



Plastic Sheet Stock



## Duets® Laser XT Outdoor/Indoor Sheet Stock



D B R L S SC

### 1/16" Thick Brushed Metal

<b>L-903-136</b> Brushed Old Gold/Red	<b>L-903-156</b> Brushed Old Gold/Blue	<b>L-903-106</b> Brushed Old Gold/Black	<b>L-904-106</b> Brushed Copper/Black
<b>L-901-136</b> Brushed Stainless/Red	<b>L-901-156</b> Brushed Stainless/Blue	<b>L-901-106</b> Brushed Stainless/Black	<b>L-902-106</b> Brushed Nickel/Black

**SPECIAL ORDER**



All metals are also available in 1/32" & 1/8" by special order.

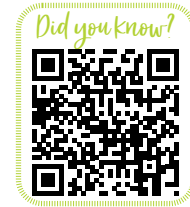

## Duets® Dura-Guard™ Laser XT Sheet Stock



D B R L S SC

Engraving Depth: .003"  
 Full Sheet: 24" x 49"  
 Use: Interior/Exterior - UV Stable  
 Material: Microsurfaced Impact Modified Acrylic

Dura-Guard provides additional abrasion and wear resistance to the most demanding applications. It is ideal for wayfinding, exterior branding, industrial labeling and awards and recognition.



### 1/16" Thick Matte (Non-Glare)

<b>L-100-116-DG</b> Black/White	<b>L-102-116-DG</b> Red/White	<b>L-111-106-DG</b> White/Black	<b>L-116-106-DG</b> Yellow/Black	<b>L-104-116-DG</b> Blue/White
------------------------------------	----------------------------------	------------------------------------	-------------------------------------	-----------------------------------



## TOUGH Material that Lasers EASY!

**SPECIAL ORDER**

Other Laser XT colors are also available with Dura-Guard & 1/8" by Special Order.

**SPECIAL ORDER**

All colors available in 1/32" & 1/8" by special order.

Custom combinations of colors available (Set up fee may apply.) (1/8" available in 2-ply & 3-ply with black or white base color.)

- Capabilities:**
- Scores
  - Shears
  - Saws
  - Drills
  - Laser Vector Cuts
  - Bevels
  - Heat Bendable
  - Screen Prints
  - Hot Stamps
  - Fine Engraving
  - Bonds
  - UV Stable
  - CNC Routes

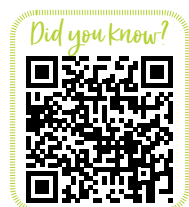

**Duets Sample Swatch Binder:**  
 Purchase a Duets® Swatch Binder. Item #DBINDER  
 Contact us for **FREE** binder swatch replacements.



**IMPORTANT:**  
 Add "Q" for quarter sheet (12" x 24") or "H" for half sheet (24" x 24") to the end of the part number when ordering. Part number as listed indicates "Full" sheet.

**AP** AP Customers get best price when ordering any 10 quarter sheets, 10 half sheets or 5 full sheets of plastic sheet stock.

Plastic Sheet Stock



D B R L S SC

# Duets<sup>®</sup> Rotary Indoor Sheet Stock

Engraving Depth: .003"  
 Full Sheet: 24" x 49"  
 Use: Interior  
 Material: Microsurfaced ABS

For indoor wayfinding and labeling, Duets Rotary Indoor offers a wide variety of high contrast colors and metallic finishes for your indoor rotary engraving projects.



**Applications:**  
 Architectural Signage  
 Egress / Exit Signage  
 Interior Signage  
 Industrial Signage  
 Personal Identification  
 Safety Signage  
 Trophies, Awards, & Plaques  
 Wayfinding

**Characteristics:**  
 Front engravable  
 Indoor  
 UV-LED Printable

**Capabilities:**  
 Scores  
 Shears  
 Saws  
 Drills  
 Bevels  
 Heat Bendable  
 Screen Prints  
 Hot Stamps  
 Fine Engraving  
 Bonds  
 CNC Routes

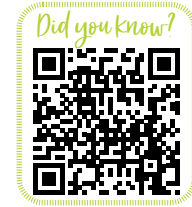

## 1/16" Thick Matte (Non-Glare)

<b>R-111-136</b> White/Red	<b>R-111-216</b> White/Maroon	<b>R-111-156</b> White/Blue	<b>R-111-176</b> White/Spring Green	<b>R-111-186</b> White/Evergreen	<b>R-111-106</b> White/Black
<b>R-116-106</b> Yellow/Black	<b>R-103-116</b> Orange/White	<b>R-102-116</b> Red/White	<b>R-117-116</b> Maroon/White	<b>R-119-116</b> Pink/White	<b>R-119-106</b> Pink/Black
<b>R-121-116</b> Light Blue/White	<b>R-118-116</b> Grey/White	<b>R-104-116</b> Blue/White	<b>R-105-116</b> Sapphire/White	<b>R-106-116</b> Navy/White	<b>R-120-116</b> Purple/White
<b>R-107-116</b> Spring Green/White	<b>R-122-116</b> Light Green/White	<b>R-108-116</b> Evergreen/White	<b>R-114-166</b> Beige/Chocolate Brown	<b>R-115-106</b> Khaki/Black	<b>R-110-116</b> Brown/White
<b>R-109-116</b> Chocolate Brown/White	<b>R-113-116</b> Cool Grey/White	<b>R-113-216</b> Cool Grey/Maroon	<b>R-113-226</b> Cool Grey/Navy	<b>R-113-106</b> Cool Grey/Black	<b>R-100-116</b> Black/White

Plastic Sheet Stock



DBRLS SC

## Duets® Rotary Indoor Sheet Stock - (Continued)

### 1/16" Thick Woods



† May be slightly under 24"



**Duets**  
BY GEMINI  
STOCKING PARTNER

### 1/16" Thick Metals

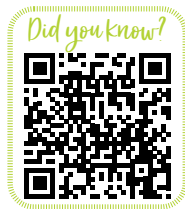
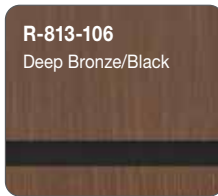
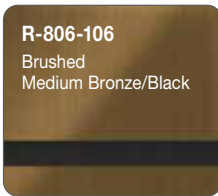
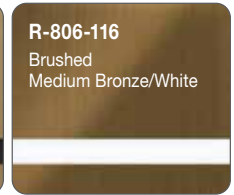
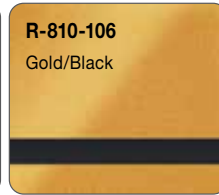
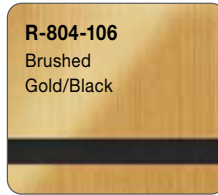
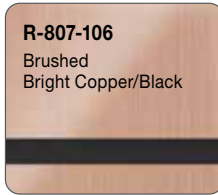
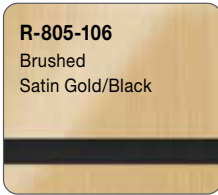

**Duets Sample Swatch Binder:**  
Purchase a Duets® Swatch Binder. Item #DBINDER  
Contact us for **FREE** binder swatch replacements.



**SPECIAL ORDER**

Metals are also available with Clear-Guard® coating by special order.

Custom combinations of colors available (Set up fee may apply.)  
(1/8" available in 2-ply & 3-ply with black or white base color.)



AP Customers get best price when ordering any 10 quarter sheets, 10 half sheets or 5 full sheets of plastic sheet stock.

**IMPORTANT:**

Add "Q" for quarter sheet (12" x 24") or "H" for half sheet (24" x 24") to the end of the part number when ordering. Part number as listed indicates "Full" sheet.

Wood Sheet Stock

# Magnetic Badge Attachments

DBRLS SC

Eliminate holes in clothing. All Magnetic Badge Attachments are self-adhesive.



**MP101 - Set\***  
Magnet - 1 Post



**MP300 - Set**  
Magna Power - 2 Post



**MP301 - Set**  
Large Power Mag - 2 Post



**MP304 - Set**  
Large Power Mag - 3 Post



**MP305 - Set**  
Small Power Mag - 2 Post



**MP311 - Set**  
Small Black Plastic Covered - 2 Post



**MP313 - Set**  
Large Black Plastic Covered - 3 Post



**MP321 - Set**  
Large Black Plastic Covered - 2 Post



**MP323 - Set**  
Blue Plastic Covered - 3 Post



**MP324 - Set**  
Green Plastic Covered - 3 Post

## Easy Peel Pull Tabs for Quick Assembly



\* MP101 does not include easy peel tabs.

Part No.	Size	Weight	Case Qty.
MP101	11/16" Diameter	5 g	250
MP300	1 3/4" x 1/2"	11 g	50
MP301	1 3/4" x 1/2"	12 g	50
MP304	1 3/4" x 1/2"	13 g	50
MP305	1 1/2" x 3/8"	9 g	50
MP311	1 1/4" x 1/2"	6 g	50
MP313	1 3/4" x 1/2"	11 g	50
MP321	1 3/4" x 1/2"	10 g	50
MP323	1 3/4" x 1/2"	11 g	50
MP324	1 3/4" x 1/2"	11 g	50







**D B R L S S C**

## Metal Badge Blanks

Heavy Gauge Name Badge Blanks with fused posts. Badges are .040" thick and have radius corners of 1/8". Includes clutches.

Case Qty: **100**



Satin Leaded Brass



Bright Leaded Brass



Bright Nickel Silver



Satin Nickel Silver

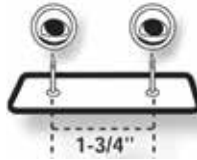

Part #	Description
565-9110FP	2 3/8" x 1/2" Satin Leaded Brass
565-9120FP	2 3/8" x 1/2" Bright Leaded Brass
565-9136FP	2 3/8" x 1/2" Bright Nickel Silver
565-9137FP	2 3/8" x 1/2" Satin Nickel Silver
566-9110FP	2 1/2" x 5/8" Satin Leaded Brass
566-9120FP	2 1/2" x 5/8" Bright Leaded Brass
566-9136FP	2 1/2" x 5/8" Bright Nickel Silver
566-9137FP	2 1/2" x 5/8" Satin Nickel Silver

## Plastic Badge Frames

Plastic Badge Frames have flat backs to attach findings.

See pages 260 & 262 for magnets & badge findings. See below for pre-cut badge blanks to fit these frames.

Case Qty: **100**



**D B R L S S C**

**SAMPLE SET #BBSET**



Description	Gold	Silver	Black
3" x 1" Square Corner Badge Frame	RP82931	RP82931S	RP82931BK
3" x 1 1/2" Square Corner Badge Frame	RP82932	RP82932S	RP82932BK
3" x 1 1/2" Oval Badge Frame	RP83851	RP83851S	RP83851BK
3" x 1" Round Corner Badge Frame	RP83852	RP83852S	RP83852BK
3" x 1 1/2" Round Corner Badge Frame	RP83853	RP83853S	RP83853BK

## Plastic Blanks

Plastic Badge Blanks are 1/16" Duets Laser XT plastic. Plastic Badge Blanks can be lasered, engraved or printed on. Badge Blanks are designed to fit the frames above or can be used as stand alone badges.

Case Qty: **50**



**D B R L S S C**

Surface Color	Engraves	3" x 1" Square Corner Badge	3" x 1 1/2" Square Corner Badge	3" x 1 1/2" Oval Badge	3" x 1" Round Corner Badge	3" x 1 1/2" Round Corner Badge
White	Black	BB100	BB200	BB300	BB400	BB500
Black	White	BB103	BB203	BB303	BB403	BB503
Brushed Silver	Black	BB108	BB208	BB308	BB408	BB508
Brushed Gold	Black	BB109	BB209	BB309	BB409	BB509

Material Specifications:	Material Specifications:
Scores	✓ Ink Prints
Saws	✓ Thermal Prints
Drills	✓ Permits Fine Engraving
Shears	✓ Bonds
Laser Vector Cuts	✓ UV Stable
Bevels	✓ Back-Filling
Heat Bendable	✓ Back-Lighting
Screen Prints	✓ Braille-Engravable
Hot Stamps	✓

Description
3" x 1" Square Corner Badge Blank
3" x 1 1/2" Square Corner Badge Blank
3" x 1 1/2" Oval Badge Blank
3" x 1" Round Corner Badge Blank
3" x 1 1/2" Round Corner Badge Blank

Badge Blanks are Not Beveled

Badges, Findings & Magnets

## Badge Findings

Case Qty: 100

DBRLSSC



**JD130D**  
Self-Adhesive  
Bulldog Clip



**JD132D**  
Self-Adhesive Plastic  
Bulldog Clip



**JD133D**  
Self-Adhesive Plastic  
Bulldog Clip with Pin



**JD134D**  
Bulldog Clip with  
Plastic Strap

## Self-Adhesive and Glue On Bar Pins

Case Qty: 100



**JD101D**  
White Rounded Plastic Bar Pin  
Size: 1 1/2"



**JD102D**  
White Rounded Self-Adhesive  
Plastic Bar Pin  
Size: 1 1/2"



**JD103D**  
White Square Self-Adhesive  
Plastic Bar Pin  
Size: 1 1/2"



**JD110D**  
Clear Top Opening Vinyl  
Backed Bar Pin  
Size: 1 1/2"



**JD120D**  
Clear Top Opening  
Self-Adhesive Bar Pin  
Size: 1 1/2"



**JD155D**  
Black Side Opening Vinyl  
Backed Bar Pin  
Size: 1 1/2"



**JD156D**  
Black Side Opening  
Self-Adhesive Bar Pin  
Size: 1 1/2"



**JD140D**  
Clear Double Post Bar  
Pin with Clutches



**JD154D**  
Black Self-Adhesive Double  
Post Bar Pin with Clutches



**JD150D**  
Butterfly Clutch



**JD152D**  
Clear Single Post Pin  
with Clutch



**JD153D**  
Black Single Post Pin  
with Clutch

Badges, Findings & Magnets

## Plastic & Acrylic Bonding Solution



**PBS1**  
1 quart (fast drying,  
clear liquid solvent for  
welding plastic or acrylic)

**PBS1 can only be  
shipped by ground in  
the contiguous U.S.**

# Badge Clips, Holders & Lanyards

DBRLSSC

Case Qty: 100



**JD170A**  
Clear Plastic Pocket Badge  
Overall Size: 2 7/8" x 2 1/16"



**JD205D**  
Convention Badge with Bulldog & Pin  
Overall Size: 3 5/8" x 2 1/4"  
Holds: 3 1/2" x 2 1/8" Insert



**JD208D**  
ID Holder/Convention Badge  
with Holes and Slot  
Overall Size: 3 13/16" x 3 1/16"  
Holds: 3 5/8" x 2 1/2" Insert



**JD209D**  
ID Holder/Convention Badge  
with Bulldog on Strap  
Overall Size: 3 15/16" x 3 1/4"  
Holds: 3 11/16" x 2 3/8" Insert



**JD251D**  
Black Retractable Badge  
Reel with Belt Clip & Strap



**JD210D**  
1/4" x 5" Leather Strap



**JD220D**  
6" Clear Plastic Strap

(Lanyard is 3/8" x 36" long. Neck hole is 3/2")



**R110BK**  
Black Lanyard with Hook  
and Adjustable Ball

**R110BU**  
Blue Lanyard with Hook  
and Adjustable Ball

**R110RD**  
Red Lanyard with Hook  
and Adjustable Ball

**R110WT**  
White Lanyard with Hook  
and Adjustable Ball

Badges, Findings & Magnets







# Resources

*if you're looking for:*

VINYL ORDERING INFORMATION

HOW TO BUILD A CUT VINYL NUMBER

VINYL APPLICATION CHARTS

HEAT TRANSFER APPLICATION CHARTS

PROCESS ICON EXPLANATIONS

HOW TO LOCATE ICC PROFILES

INDEX

## FABRICATION & WHOLESALE SIGN PRINTING SERVICES

SUBLIMATION • ENGRAVING • LASERING • SANDCARVING  
UV PRINTING • CNC ROUTING • CUSTOM CUTTING

### Quote Requests and Ordering Information:

All artwork and quote requests should be emailed to: [art@jdsindustries.com](mailto:art@jdsindustries.com)  
Artwork can also be uploaded directly to JDS Industries via the "Art Upload" feature located at [jdsindustries.com](http://jdsindustries.com)  
Once logged in, locate the "Art Upload" button located in the "Site Features" section. Click on the button and follow the instructions to quickly and easily upload your artwork.

Please follow the art requirements to ensure that your custom order is processed quickly and accurately.  
Art charges will apply if art is not in an acceptable format.

**F.O.B Sioux Falls, SD only.**  
**\$99 Free Freight applies to fabrication orders.**

Production time does not include transit time and will vary with type of artwork and quantity needed.  
Production time begins when order is confirmed and artwork and purchase order are received.  
Most fabrication orders are 3-5 days.  
Rush Service may be available for an additional charge.

See Price List for custom cut metal, plastic and plexi.

We reserve the option to refuse any order which we consider impossible to reproduce within industry standards.

### When ordering fabrication services please specify:

- Size and type of material (part number if possible)
- Quantity
- If holes, specify if rounded or notched corners or beveling are required (if applicable)
- If you need adhesive on the back (if applicable)
- Imprint colors (if applicable)
- Orientation
- Any special instructions

### JDS CNC Router Services

JDS can cut shapes from any metal, plastic, hardboard or FRP Sheetstock in this catalog. This allows you to custom order unique shapes using our CNC router service.  
Send your quote request and artwork to: [art@jdsindustries.com](mailto:art@jdsindustries.com)

Production time is typically 3-5 days (upon receipt of artwork and depending on size of order).

Certain parameters and requirements apply. Our Custom Order Specialists will help you in making this determination. Ask for details.



### Direct Color Print

JDS can print full color images on many flat substrates & drinkware including Polar Camels, Laserable Leatherette, glass, crystal, acrylic, wood or plastic. Send your quote request and artwork to: [art@jdsindustries.com](mailto:art@jdsindustries.com)

Production time is typically 3-5 days (upon receipt of artwork and depending on size of order).

Large quantities may be more cost effective to produce using screen printing. Certain parameters and requirements apply. Our Customer Order Specialists will help you in making this determination. Ask for details.

## Artwork Requirements:

Artwork is PREFERRED in the following PC formats: CorelDraw (.cdr) or Adobe Illustrator (saved as .eps or .pdf file format).

All digital artwork should be supplied as line art (vector art). For color artwork please specify the exact PMS colors used. All type must be converted to outlines (curves). Hard copy artwork should be as large as possible within an 8.5" x 11" for scanning purposes. Digital images should be vector artwork (not bitmapped/raster) and saved in either CorelDraw or Adobe Illustrator as an EPS (encapsulated PostScript) file WITHOUT COMPRESSION.

DO NOT send raster images that are embedded within another file, such as within Microsoft Word, PowerPoint, Publisher, etc.

Images that contain halftones, tints, grayscales or are intended for process color separation should have a bitmap resolution of at least 300 pixels-per-inch and supplied at finished size or larger. All artwork files should also be emailed in a PDF format for reference.

Word documents, faxes, photocopies, business cards & letterhead are NOT considered acceptable artwork and CANNOT BE USED FOR ARTWORK.

JPEGs, GIFFs, TIFFs and all other bitmap files (not vector based) can be submitted for use at a resolution of NO LESS than 300 pixels-per-inch and supplied at finished size or larger.

## What if I don't have artwork or my artwork is not acceptable?

Layout of copy and art will be at JDS Industries' discretion unless specifications are clearly marked on the order or finished art is supplied. Finished products are only as good as the artwork supplied. Please make sure your artwork is acceptable before submission. JDS Graphics Staff can help you with your artwork for a charge of \$60 per hour.

## What if I need a PMS Match?

Due to inherent technical differences in color monitors, the colors depicted in the electronic proof may not exactly match those in the final product. Please specify required PMS colors. We make every effort to match requested colors, but cannot guarantee a 100% exact match. Colors are matched as close as possible to the requested color but may vary slightly. For this reason an exact PMS match cannot be guaranteed.



Services



## Fabrication Services:

Phone: 855.537.2228

Email: [art@jdsindustries.com](mailto:art@jdsindustries.com)

Mailing Address:

JDS Industries

Attn: Fabrication

1800 E 57th St N

Sioux Falls, SD 57104



## VINYL ORDERING INFORMATION

**Vinyl Products Stocking:**

JDS stocks several series of 24" vinyl rolls. All popular colors are stocked in all 14 warehouses with less popular colors stocked in select warehouses. We've partnered with leading industry providers to ensure our direct shipped products ship quickly! See each series for more details.

**1 yard (cut vinyl only):**

We know that certain jobs require unique colors in less than full roll quantities. JDS Sign Supply is prepared to process your "by the yard" order so you get exactly what you need for your next job! "By the yard" orders will be treated like a custom product and are not returnable. See each line for availability.



**3M™ Products**

3M Products can **ONLY** be distributed to customers in the United States and US Territories.



**Avery Dennison® Products**

Avery Dennison® Products can **ONLY** be distributed to customers in the United States and US Territories.

**For all your sign supply questions, call us at 855.661.2388**

Services





# HOW TO BUILD A CUT VINYL PART NUMBER

### The first four (4) digits

in our part number identify the series of product. (These four digit numbers can be located at the top of the info charts within each series. They may not always be the same as the series number. Refer to the chart for each series to ensure you have the correct number.)



680CR Series - Premium Film		
Use 6801 for Part Number		
Film	10 yard	5
15"	158.50	74
30"	259.05	14

**When ordering punched product** refer to the notes for each series to identify the correct number to order. These will be the first (4) digits of your part number for punched product.



**Note: Punched film is only available in 15" & 30" - use part number 6851.**  
**Note: This series is Gerber punched.**  
 Note: See page 10 for how to build a part number.  
 Note: See price list in back for pricing.  
 Note: Colors shown are approximate.

### The second four (4) digits

identify the material converted size. The first two digits indicate the width and the last two digits indicate the length.

**Note: See chart below for width and length codes.**

### The final three (3) digits

identify the color, and all colors contain three digits.

**4200** - **1515** - **014**

Unpunched  
2.8 mil Calendered

Width = 15"

Length = 150' (50 yds)  
(The 0 in 150 is hidden)

Color 014 (Tomato Red)

**4250** - **3003** - **003**

Punched  
2.8 mil Calendered

Width = 30"

Length = 30' (10 yds)  
(The 0 in 30 is hidden)

Color 003 (Gloss Black)

**Notes:**

**Standard punch is slot pattern. IBM and 3-hole punch patterns are available. Except for 3M Reflective Series which is Gerber punched.**

Width and Length					
Part number codes for the second four (4) digits					
Width	5 yard*	10 yard	25 yard**	50 yard	55 yard*
15"	1502	1503	1508	1515	1517
24"	2402	2403	2408	2415	2417
30"	3002	3003	3008	3015	3017
48"	4802	4803	4808	4815	4817

\* Heat Transfer Only  
 \*\* Select Materials

## Kota Pro™ Heat Transfer Material

Width and Length		
Part number codes for the second four (4) digits		
Width	54 yard	27 yard
15"	1554*	
20"		2027**
30"		3027**
60"		6027**

\* Heat Transfer Only  
 \*\* Select Materials



# Digital Print Vinyl

Charts & Resources

Print Media	PAGE NUMBER	Face Finish	Adhesive	COMPATIBILITY			APPLICATIONS											
				Eco-Solvent	UV-Curable	Latex Inks	Fleet/Vehicles	Transit/Bus	Textured Walls	Vehicle Windows	Marine/Watercraft	Backlit Signs	Smooth Interior Walls	POP/Tradeshows	Window Graphics (Flat)	Outdoor Signage	Indoor Floor Graphics	
<b>SUPERCAST</b> 7-10 Years Durability	MPI 1105 Easy Apply RS	9	Gloss	LTR	•	•	•	•	•					•	•		•	
	MPI 1105 Easy Apply™	9	Gloss	LTR	•	•	•	•	•				•	•		•		•
	MPI 1106 High Tack Easy Apply™	10	Gloss	Perm	•	•	•						•	•			•	
	MPI 1405 PVC Free Easy Apply™ RS	10	Gloss	LTR	•	•	•				•			•	•		•	
<b>HIGH PERFORMANCE CALENDERED</b> 4-6 Years Durability	MPI 2050 Translucent	12	Matte	Perm	•	•	•						•	•				
	MPI 2105 Easy Apply RS™	12	68Gloss	LTR	•	•	•	•	•					•	•		•	•
	MPI 2105 Easy Apply™	12	Gloss	LTR	•	•	•	•	•					•	•		•	•
	MPI 2126 High Tack Easy Apply™	12	Matte	Perm	•	•	•					•		•	•		•	
	MPI 2611 Wall Film	19	Luster	Rem	•	•	•							•	•			
MPI 2630 Textured Wall Film	19	Textured	Perm	•	•	•							•	•				
<b>INTERMEDIATE CALENDERED</b> 2-5 Years Durability	MPI 2903 Easy Apply™	16	Gloss	Perm	•	•	•				•			•	•		•	•
	MPI 2903	16	Gloss	Perm	•	•	•				•			•	•		•	•
	MPI 2902	13	Gloss	Rem	•	•	•	•	•	•				•	•		•	•
	MPI 2920	15	Matte	Perm	•	•	•				•			•	•		•	•
	MPI 2923 Easy Apply™	16	Matte	Perm	•	•	•							•	•		•	•
	MPI 2921 Easy Apply™	13	Matte	Rem	•	•	•	•	•					•	•		•	•
	MPI 2921 StaFlat™	13	Matte	Rem	•	•	•	•	•					•	•		•	•
<b>PROMOTIONAL CALENDERED</b> 1-3 Years Durability	MPI 3300 & MPI 3303	28	Gloss	Perm	•	•	•				•			•	•		•	•
	MPI 3320 & MPI 3323	29	Matte	Perm	•	•	•				•			•	•		•	•
<b>REFLECTIVE</b> 7 Years Durability	V4000 Reflective	71	Gloss	LTR	•	•	•	•								•		•

# Application Chart

	OUTDOOR VERTICAL DURABILITY (UP TO X YEARS)									ADHESIVE REMOVABILITY			CONFORMABILITY					
	Unprinted	DOL 1000Z Series	DOL 1300Z	DOL 1460Z	DOL 2000Z Series	DOL 3000Z Series	DOL 6460	DOL 1060 Max	DOL 1360 Max	Clean	Clean with Heat	Permanent	Flat with Rivets	Compound Curves	Rivets/Coorugation	Flat/Simple Curves	Flat	
<b>Print Media</b>																		
<b>SUPERCAST</b> 7-10 Years Durability	MPI 1105 Easy Apply RS	7	5	4	4	-	-	2	7	7		•		•	•	•	•	•
	MPI 1105 Easy Apply™	7	5	4	4	-	-	2	7	7		•		•	•	•	•	•
	MPI 1106 High Tack Easy Apply™	7	5	4	4	-	-	2	7	7			•	•	•	•	•	•
	MPI 1405 PVC Free Easy Apply™ RS	12	-	-	-	-	-	-	7	7		•		•	•	•	•	•
<b>HIGH PERFORMANCE CALENDERED</b> 4-6 Years Durability	MPI 2050 Translucent	6	5	4	4	3	2	2	5	4			•				•	•
	MPI 2105 Easy Apply RS™	6	5	4	4	3	2	2	5	4		•					•	•
	MPI 2105 Easy Apply™	6	5	4	4	3	2	2	5	4		•					•	•
	MPI 2126 High Tack Easy Apply™	6	5	4	4	3	2	2	5	4			•				•	•
	MPI 2611 Wall Film	4	3	3	3	3	2	2	3	3	•						•	•
	MPI 2630 Textured Wall Film	3	-	-	-	-	-	-	-	-			•				•	•
<b>INTERMEDIATE CALENDERED</b> 2-5 Years Durability	MPI 2903 Easy Apply™	5	5	4	4	3	2	3	5	4			•				•	•
	MPI 2903	5	5	4	4	3	2	3	5	4			•				•	•
	MPI 2902	5	5	4	4	3	2	3	5	4	•						•	•
	MPI 2920	5	5	4	4	3	2	3	5	4			•				•	•
	MPI 2923 Easy Apply™	5	5	4	4	3	2	4	5	4			•				•	•
	MPI 2921 Easy Apply™	1	1	1	1	1	1	1	1	1	•						•	•
	MPI 2921 StaFlat™	1	1	1	1	1	1	1	1	1	•						•	•
<b>PROMOTIONAL CALENDERED</b> 1-3 Years Durability	MPI 3300 & MPI 3303	3	3	3	3	3	2	3	3	3			•				•	•
	MPI 3320 & MPI 3323	3	3	3	3	3	2	3	3	3			•				•	•
<b>REFLECTIVE</b> 7 Years Durability	V4000 Reflective	7	5	4	4	-	-	6	5	4	•			•		•	•	•



# Digital Print Vinyl Application Chart

Charts & Resources

Series	PAGE NUMBER	APPLICATIONS										APPLICATION SURFACES			
		General Signage, Displays, P.O.P.	Decals & Stickers	Vehicle Wraps	Fleet & Vehicle Graphics	Windows Removable	Windows Permanent	Walls (Smooth Dry Wall-Removable)	Walls (Moderately Textured Surfaces/ Brick & Block Removable)	Floors (Tile & Smooth Sealed Cement)	Carpet (short loop commercial)	Clear (Transparent)	Low Surface Energy	Semi Rigid	Outdoor
830 AutoMark	8	•		•	•									•	•
230 AutoMark	11	•		•	•									•	•
333 AutoMark	11	•		•	•									•	•
202 Matte	14	•				•								•	•
204 Gloss	14	•				•								•	•
221 Gloss	14	•				•						•		•	•
223 Matte	14	•				•						•		•	•
201 Matte	14	•												•	•
203 Gloss	17	•												•	•
201 OAPAE	16	•												•	•
203 OAPAE	16	•												•	•
220 Gloss	17	•										•		•	•
222 Matte	17	•										•		•	•
201-HTAP/AE	16	•									•			•	•
234	20	•						•							•
235	18			•											•
226	20	•						•				•			•
285	21								•		•				•
255	22	•				•					•			•	•
232	23	•		•	•	•								•	•
270	23	•				•								•	•
280	24	•				•								•	•
790AE	24						•							•	•
210	27	•										•			•
212	26	•										•			•
765 Rainbow Holographic	31	•	•			•								•	•



# 3M Cut Vinyl Application Chart

	PAGE NUMBER	FILM CHARACTERISTICS							COMPATIBILITY			APPLICATIONS						APPLICATION SURFACES				PROCESSING/ PRINTING				
		Expected Performance Life	Film Thickness (mils)	Warranty	Permanent	Removable	Pressure-Activated	Non-Visible Air Release Channels	Solvent	UV-Curable	Latex Inks	Fleet/Vehicles	Transit/Bus	Railroad	OEM Graphics	Label (warning, information)	Signage (non-backlit)	Cut Letters/Shapes	Backlit Signage	Window Graphics	Flat, Simple Curves	Flat with Rivets	Compound Curves	Corrugated	Thermal Transfer	Screen Printable
<b>Print Media</b>																										
<b>CAST</b>	3M Controltac 180mC	60	10	2	•	•	•	•	•	•	•	•	•	•	•	•	•	•	•	•	•	•	•	•	•	•
	3M Scotchcal 3630	62	10	2		•									•	•			•					•	•	
	3M Scotchcal 7125	56	8	2	•	•			•	•		•	•		•	•	•		•	•	•				•	•
	3M Scotchcal 7725	58	8	2	•	•			•	•		•	•		•	•	•		•	•	•				•	•
	3M Scotchcal 7725SE	77	1	2-3.8	•	•			•	•					•	•	•	•	•	•	•					•
<b>CALENDERED</b>	3M Scotchcal 50	64	5	3				•	•		•			•	•	•		•	•					•		
<b>RETRO-REFLECTIVE</b>	3M Scotchlite 5100R	74	7	6				•	•					•	•	•				•					•	
	3M Scotchlite 680	72	9	7				•	•					•	•	•				•				•	•	
	3M Scotchlite 680CR	73	9	7				•	•					•	•	•				•					•	



<b>RETRO-REFLECTIVE</b>	Avery Dennison V4000 Printable (White Only)	71	7	7.9							•	•		•	•	•				•	•	•	•			
-------------------------	---	----	---	-----	--	--	--	--	--	--	---	---	--	---	---	---	--	--	--	---	---	---	---	--	--	--

Charts & Resources

**Lumina**  
by FDC

**VinylEfx**  
METALIZED VINYL

# Cut Vinyl Application Chart

Charts & Resources

PRODUCT TITLE	FILM CHARACTERISTICS					PROCESSING/PRINTING					APPLICATIONS				APPLICATION SURFACES				PAGE #	
	Cal	5	2.8	P																
Lumina 4200 Series	Cal	5	2.8	P	•			•				•	•		•	•				66
Lumina 4301 Series	Cal	1	3	R				•					•		•	•				67
VinylEfx 2824-2831	M	-	3	P		•	•	•				•	•			•				78
VinylEfx 4826-4827	M	3	3	P	•	•	•	•		•		•	•	•	•	•				79
VinylEfx 4310	N	-	4-6	P				•					•		•					80

NOTE: The above products are not recommended for Backlit Signs and Vehicle Wraps.





# Color Change Film

## SW 9200 & SW 900X Durability

Months	ZONE 1		ZONE 2		ZONE 3		PAGE #
	Vertical	Non Vertical/ Horizontal	Vertical	Non Vertical/ Horizontal	Vertical	Non Vertical/ Horizontal	
SW900 Black & White	12 Years	3 Years	9.6 Years	6 Months	5.8 Years	4 Months	48
SW900 Colors	10 Years	2 Years	8 Years	6 Months	4.8 Years	4 Months	48
SW900 Metallics & Pearlescents	5 Years	2 Years	18 Months	6 Months	2.4 Years	4 Months	48
SW900 Metallics (with gold flake)*	36 Months	12 Months	30 Months	6 Months	18 Months	4 Months	48
SW900X Textured Films	48 Months	12 Months	36 Months	6 Months	24 Months	4 Months	52
SW900 Diamond Line	36 Months	12 Months	30 Months	6 Months	18 Months	4 Months	52
SW900 Color Flow Series	48 Months	12 Months	36 Months	6 Months	24 Months	4 Months	51

**NOTE: Non-vertical:** The face of the graphic is between 10° to 45° from vertical. Specifically for Supreme Wrapping Film (SW900) Non-vertical exposure performance will be calculated using the Horizontal exposure value.

**Horizontal:** The face of the graphic is between 45° and 90° from vertical, for Supreme Wrapping Film (SW900) Horizontal applications will be warranted as stated in this ICS Performance Guarantee Bulletin.

**Vertical:** The face of the graphic is between 0 and 10 degrees from vertical.



# Heat Transfer Material

Series	PAGE NUMBER	Safety	Mil Thickness	Film Type	Finish	Cut	Blade	
<b>KOTA<sub>PRO</sub></b>	Cut	108	Oeko-Tex Standard 100	3.1	PU	Matte	Reverse	45°
	Clear Print	110	Oeko-Tex Standard 100	3.1	PU	Clear	Reverse	45°
	Print	109	Oeko-Tex Standard 101	3.1	PU	Matte	Right Read	45°
 Heat Transfer Material for Textiles	FlexCut Maxx	137	CPSIA Compliant	2.4	PU	Matte	Reverse	45°
	FlexCut Atomic	139	CPSIA Compliant	2.4	PU	Pearlescent	Reverse	45°
	FlexCut Nylon	139	CPSIA Compliant	2.8	PU	Matte	Reverse	45°
	Flexcut SBB	138	CPSIA Compliant	4.1	PU	Semi-gloss	Reverse	45°
	Tattoo SBB	138	CPSIA Compliant	3.9	PU	Satin	Right Read	45°
	MetalFlex	140	CPSIA Compliant	1.6	PU	Foil	Reverse	45°
	ReflectCut	140	CPSIA Compliant	5.9	PU	Reflective	Reverse	45°
	Graffiti	141	CPSIA Compliant	2.4	PU	Matte	Right Read	45°



# Heat Transfer Material

Series	Compatibility	Temp	Pressure	Time	Peel	Transfer Tape Required
Cut	Most Fabrics	285°F	Medium	4 sec	Hot	No
Clear	Most Fabrics	350°F	Medium	10 sec	Hot	No
Print	Most Fabrics	285°F	Medium	4 sec	Hot	Yes
FlexCut Maxx	Most Fabrics	330°F	Cotton: Medium Poly: high	15-17 sec	Hot/Warm	No
FlexCut Atomic	Most Fabrics	330°F	Cotton: Medium Poly: high	15-17 sec	Hot/Warm	No
FlexCut Nylon	Most Fabrics	240°F	Cotton: Medium Poly: high	15 sec	Hot/Warm	No
Flexcut SBB	Most Fabrics	265°F	Medium/High	10 sec	Cold	No
Tatoo SBB	Most Fabrics	275°F	Medium/High	10 sec	Cold	No
MetalFlex	Most Fabrics	340°F	Cotton: Medium Poly: high	20 sec	Warm	No
ReflectCut	Most Fabrics	302°F	Medium/High	15-17 sec	Cold	No
Graffiti	Most Fabrics	265°F	Medium/High	20 sec	Hot/Warm	Yes

# Heat Transfer Material

 <b>Series</b>	PAGE NUMBER	Safety	Thickness (Microns)	Finish	Graphtec Force	Blade	Cutter Speed
CAD-CUT UltraWeed	112	CPSIA Certified	90-100	Matte	7-9	45°	20 cm/s
CAD-CUT Thermo-FILM	113	CPSIA Certified	190	Semi-Gloss	18-20	45°	30 cm/s
CAD-CUT Thermo-GRIP	113	CPSIA Certified	190	Semi-Gloss	18-20	45°	30 cm/s
CAD-CUT Premium Plus	114	CPSIA Certified	80-108	Matte	9-11	45°	20 cm/s
CAD-CUT Sportsfilm Lite	115	CPSIA Certified	100	Semi-Matte	9-11	45°	30 cm/s
CAD-CUT Silicone Dye-Block	116	CPSIA Certified	200	Matte	11-13	45°	20 cm/s
CAD-CUT GORILLA GRIP II	117	CPSIA Certified	80	Matte	8-10	45°	30 cm/s
CAD-CUT Soft Foam	118	CPSIA Certified	560-600	Matte	24-26	45°	20 cm/s
CAD-CUT Soft Flock	119	CPSIA Certified	485	Velvet	11-13	45°	25 cm/s
CAD-CUT Fashion-FILM Electric	120	CPSIA Certified	88	Matte	8-10	45°	30 cm/s
CAD-CUT Glitter Flake	121	CPSIA Certified	325	Textured Glitter	18-22	45°	30 cm/s
CAD-CUT Hologram	122	CPSIA Certified	100-115	Gloss	15-17	45°	30 cm/s
CAD-CUT UV Shift	123	CPSIA Certified	110	Matte	7-9	45°	30 cm/s
CAD-CUT Chroma Bling	124	CPSIA Certified	150	Gloss	10-16	45°	30 cm/s
CAD-CUT Chalkboard	125	CPSIA Certified	95	Matte	8-10	45°	30 cm/s
CAD-CUT Glow	125	CPSIA Certified	100	Matte	8-10	45°	30 cm/s
CAD-CUT Reflective Glitter	126	CPSIA Certified	225	Gloss	13	45°	35 cm/s
CAD-CUT Metallic	127	CPSIA Certified	63	Gloss	8-10	45°	30 cm/s
CAD-CUT Heat Transfer Foil	128	CPSIA Certified	—	Foil	7-9	45°	20 cm/s
CAD-CUT Heat Press Adhesive	128	CPSIA Certified	—	Clear	7-9	45°	20 cm/s
CAD-CUT Puff	129	CPSIA Certified	Puffed 140	Frosted Matte	8-9	45°	30 cm/s
CAD-CUT Chroma-Twill	130	CPSIA Certified	180-200	Gloss	12	45°	20 cm/s
CAD-CUT 3M Scotchlite 5807	131	CPSIA Certified, ANSI/ISEA 107, CSA Z96, EN 471	145	Reflective	12-14	45°	30 cm/s
CAD-CUT Reflective II	131	CPSIA Certified	142	Reflective	11-13	45°	30 cm/s
CAD-COLOR Express Print	132	CPSIA Certified	88	Semi-Matte	—	—	—
CAD-COLOR Soft Opaque II	132	CPSIA Certified	80	Semi-Matte	—	—	—
SUPERTEK Sublistop	133	CPSIA Certified	120	Semi-Matte	—	—	—
SUPERTEK Opaque	133	CPSIA Certified	100	Semi-Matte	—	—	—
SUPERTEK Matte/Gloss Clear	134	CPSIA Certified	37/50	Matte/Gloss	—	—	—
CAD-COLOR Glitter	135	CPSIA Certified	392	Glitter	—	—	—
CAD-COLOR Soft Foam	135	CPSIA Certified	560-600	Ultra Matte	14	45°	25 cm/s

# Heat Transfer Material

 <b>Series</b>	Compatibility	Temp	Pressure	Time	Peel	Washes
CAD-CUT UltraWeed	Cotton • Polyester • Cotton/Poly Blends Lycra®/Spandex	Cotton: 280-300°F Synthetics: 260°F	Medium	12 sec	Hot	50
CAD-CUT Thermo-FILM	Cotton • Polyester • Cotton/Poly Blends	330°F	Medium	6-8 sec	Hot	50
CAD-CUT Thermo-GRIP	Cotton • Polyester Cotton/Poly Blends • Nylon Mesh	330°F	Medium	6-8 sec	Warm	50
CAD-CUT Premium Plus	Cotton • Polyester • Cotton/Poly Blends Lycra®/Spandex	280-300°F	Medium	8-12 sec	Hot	50
CAD-CUT Sportsfilm Lite	Cotton • Polyester • Cotton/Poly Blends Lycra®/Spandex • Nylon	302°F	Medium	10-12 sec	Warm	50
CAD-CUT Silicone Dye-Block	Sublimated Polyester • Cotton • Polyester Cotton/Poly Blends • Uncoated Nylon	Cotton: 302°F Synthetics: 290°F	Medium	10-15 sec	Cold	50
CAD-CUT GORILLA GRIP II	Cotton • Cordura® • Nylon	320°F	Light	10 sec	Cold	50
CAD-CUT Soft Foam	Cotton • Polyester • Cotton/Poly Blends	300°F	Light/Med	15 sec	Cold	50
CAD-CUT Soft Flock	Cotton • Polyester • Cotton/Poly Blends	311°F	Medium	15 sec	Warm	50
CAD-CUT Fashion-Film Electric	Cotton • Polyester • Cotton/Poly Blends Lycra®/Spandex	320°F	Medium	15 sec	Hot	50
CAD-CUT Glitter Flake	Cotton • Polyester • Cotton/Poly Blends	290°-302°F	Medium	10-12 sec	Hot	50
CAD-CUT Hologram	Cotton • Polyester • Cotton/Poly Blends	320°F	Firm	10-15 sec	Cold	25
CAD-CUT UV Shift	Cotton • Polyester • Cotton/Poly Blends	302°F	Medium	10-12 sec	Hot	50
CAD-CUT Chroma Bling	Cotton • Polyester • Cotton/Poly Blends	300°F	Medium	10 sec	Cold	25
CAD-CUT Chalkboard	Cotton • Polyester • Cotton/Poly Blends	275°F	Medium	15 sec	Warm	50
CAD-CUT Glow	Cotton • Polyester • Cotton/Poly Blends	305°F	Medium	10-15 sec	Warm	10
CAD-CUT Reflective Glitter	Cotton • Polyester • Cotton/Poly Blends	300°F	Medium	15 sec	Warm	50
CAD-CUT Metallic	Cotton • Polyester • Cotton/Poly Blends	285°F	Medium	8-10 sec	Cold	50
CAD-CUT Heat Transfer Foil	Cotton • Polyester • Cotton/Poly Blends	300°F	Firm	8-10 sec	Cold	—
CAD-CUT Heat Press Adhesive	Cotton • Polyester • Cotton/Poly Blends	300°F	Light	3-5 sec	Hot	—
CAD-CUT Puff	Cotton • Polyester • Cotton/Poly Blends	280°F	Medium	8-10 sec	Hot	25
CAD-CUT Chroma-Twill	Cotton • Polyester • Cotton/Poly Blends	302°F	Medium	20 sec	Cold	50
CAD-CUT 3M Scotchlite 5807	Cotton • Polyester • Cotton/Poly Blends Nylon • Cordura® Lycra®/Spandex	325°F	Firm	10-20 sec	Hot	50
CAD-CUT Reflective II	Cotton • Polyester • Cotton/Poly Blends • Nylon	290°F	Medium	10-12 sec	Hot	50
CAD-COLOR Express Print	Cotton • Polyester • Cotton/Poly Blends Lycra®/Spandex	300°F	Medium	15-20 sec	Warm	50
CAD-COLOR Soft Opaque II	Cotton • Polyester • Cotton/Poly Blends Lycra®/Spandex	250°F	Medium	5-7 sec	Hot	50
SUPERTEK Sublistop	Cotton • Polyester • Cotton/Poly Blends Lycra®/Spandex • Nylon • Cordura® Leather • Neoprene	280°F-300°F	Medium	Tack 5 Sec	Warm	50
SUPERTEK Opaque	Cotton • Polyester • Cotton/Poly Blends Lycra®/Spandex • Nylon • Cordura® Leather • Neoprene	280°F-300°F	Medium	Tack 5 Sec	Warm	50
SUPERTEK Matte/Gloss Clear	Cotton • Polyester • Cotton/Poly Blends Lycra®/Spandex • Nylon	280°F-300°F	Medium	Tack 5 Sec	Cold	50
CAD-COLOR Glitter	Cotton • Polyester • Cotton/Poly Blends	302°F	Medium	12 sec	Hot	50
CAD-COLOR Soft Foam	Cotton • Polyester • Cotton/Poly Blends	302°F	Medium	15 sec	Hot	50

# Duets<sup>®</sup> by Gemini

	Duets <sup>®</sup> Laser XT OUTDOOR/INDOOR	Duets <sup>®</sup> Laser XT REVERSE	Duets <sup>®</sup> Laser INDOOR	DuetsContours <sup>™</sup> FLEXIBLE
<b>CHARACTERISTICS</b>				
Laser	●	●	●	●
Rotary	●	●	●	●
Indoor	●	●	●	●
Outdoor	●	●		
UV Stable In/Out	●	●		
Matte/non-glare Finish	●	●	●	●
Gloss Finish	●		●	●
Gloss Metal Finish			●	
Brushed Metal Finish	●			●
Brushed/Satin	●		●	●
Wood Finish			●	
Patterned Finish			●	●
Textured Finish				
Front Engravable	●		●	●
Reverse Engravable		●		
Adhesive Back Options	●		●	●
Heat Bendable	●	●	●	●
Vector Cut	●			●
Shears, Scores, Drills	●	●	●	●
Saws	●	●	●	●
UV Printable	●	●	●	●
Hot Stamp, Silk Screen	●	●	●	●
Bondable	●	●	●	●
.020" (0.5mm)				●
1/32" Thickness	●		●	
1/16" Thickness	●	●	●	
1/8" Thickness	●		●	
1/4" Thickness				



# Application Chart



	Duets® Rotary INDOOR	Duets® Ultimates™ MAXIMUM DURABILITY	Duets® Ultimates™ REVERSE	Duets® Textures HIGH TRAFFIC	Duets® Selects™ ULTRA FLAT/SINGLE PASS	Duets® Accents™ ENHANCED STYLE	Duets® Tacitiles™ ADA & APPLIQUE
					●	●	●
	●	●	●	●	●	●	●
	●	●	●	●	●	●	●
		●	●	●	●	●	●
	●	●	●		●	●	●
	●					●	
	●						
	●						
	●						
				●			
	●	●		●	●	●	●
			●			●	
	●	●	●	●	●	●	●
	●	●	●	●	●	●	●
	●	●	●	●	●	●	●
	●	●	●	●	●	●	●
	●	●	●	●	●	●	●
	●	●	●	●	●	●	●
							●
	●	●	●	●	●		●
		●	●	●		●	●
						●	

Charts & Resources

# Duets<sup>®</sup> by Gemini

	Duets <sup>®</sup> Laser XT OUTDOOR/INDOOR	Duets <sup>®</sup> Laser XT REVERSE	Duets <sup>®</sup> Laser INDOOR	DuetsContours <sup>™</sup> FLEXIBLE
<b>CHARACTERISTICS</b>				
Clear-Guard™			●	
Dura-Guard™	●			
ADA Compliant		●		
ADA & Applique		●		
Fluorescent				
Architectural Signage	●	●	●	
Awards & Recognition	●	●	●	●
Egress / Exit Signage	●	●	●	
Exterior Branding	●			
Exterior Signage	●	●		
Industrial Labeling	●			
Industrial Signage	●	●	●	
Interior Branding				●
Interior Signage	●	●	●	●
Labels			●	
Personal Identification	●	●	●	
Retail Displays				●
Safety Signage	●	●	●	
Signage Substrate				
Trophies, Awards, Plaques	●	●	●	●
Wayfinding	●		●	
Colors	41	15	23	10
Page Numbers	256	249	254	255

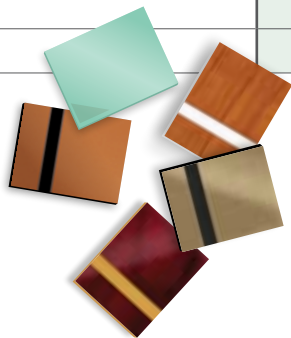

# Application Chart



	Duets® Rotary INDOOR	Duets® Ultimates™ MAXIMUM DURABILITY	Duets® Ultimates™ REVERSE	Duets® Textures HIGH TRAFFIC	Duets® Selects™ ULTRA FLAT/SINGLE PASS	Duets® Accents™ ENHANCED STYLE	Duets® Tactiles™ ADA & APPLIQUE
	•						
		•				•	•
						•	•
	•	•	•	•	•	•	•
	•	•	•	•	•	•	•
	•	•	•	•	•		•
		•	•	•	•	•	•
	•	•	•	•	•	•	•
	•	•	•	•	•	•	•
	•	•	•	•	•	•	•
	•	•	•	•	•	•	•
	•	•	•	•	•	•	•
	•	•	•	•	•	•	•
						•	
	•	•	•	•	•	•	•
	•	•	•	•	•	•	•
	43	17	8	6	16	16	50
	258	246	248	245	244	250	252

# ICONS

## JDS Sign Supply Print Process Icons



**ECO Solvent Ink** - Low-solvent ink requires a longer drying period than Solvent ink, and Lifespan of two to three years.



**Solvent Ink** - Oil based ink that maintains pigment while bonding more effectively to the substrate. Widely used for outdoor applications.



**Thermal Printing** - Produces an image by heating coated thermochromic material when it passes over the thermal print head.



**Latex Ink** - Water based pigmented inks are VOC free and require no venting.



**UV-Curable Ink** - Non-Solvent based inks that are "cured" by a UV light system.



**Screen Printing** - Versatile and durable printing process that can be done on any surface.



**Kota Pro™** is a brand of expanding products found exclusively through JDS Sign Supply. These items range from tools, sign frames, banner material & stands to standoffs.



## CONTACT US

CUSTOMER SERVICE

**855.661.2388**

SPANISH SPEAKING LINE

LINEA DE ESPAÑOL DIRECTA

**855.661.2387**

QUALITY ASSURANCE LINE

**855.537.8478**

**FAX: 605.339.1467**

## JDS Process Icons



### Diamond Drag Engraving

Recommended for engraving with a bullet-point diamond graver to "scratch" lines into a substrate.



### Burnishing

Recommended when spinning burnishing tools to remove the cap sheet of a metal substrate.



### Rotary Engraving

Recommended for engraving through spinning with a rotary tool.



### Laser Engraving

Recommended for engraving with a laser.



### Sublimation

Recommended for sublimation.



### Sandcarving

Recommended for sandcarving.

## JDS Informational Icons



**Another JDS Innovation!**



**Made in the United States of America.**

## OUR ARTWORK

The artwork that is shown on a majority of our products is, unfortunately, not available for distribution. They are purchased or created using parts of a purchased image, and the license or rights of use agreements do not allow JDS to distribute the artwork. We purchase most of the artwork you see on our product images due to the amount of time that is required to create everything from scratch.

On that note, we can tell you that we purchased the artwork from [www.bigstock.com](http://www.bigstock.com). If you search their site using keywords related to the image you are looking for, it will pull up a large variety of similar artwork.

Make sure to check the licensing agreements for each image you want to use to make sure you are purchasing the correct agreement for your intended usage.



# Where to find printer profiles



## JDS Online Resources & Tools

Select an option below

Log into [www.jdssignsupply.com](http://www.jdssignsupply.com) with your customer # and password. Once logged in click on the Resources tab.

This will bring you to our Online Resources & Tools page. Click on Printer Profiles - Download Center link. Then click the manufacturers logo to search for industry leading printer profiles.

## JDS Fabrication Resources

Artwork Upload

Trophy Building Guide

Laser Settings

Duets™ Information Page

Find color conversion charts, technical and safety data.

Printer Profile - Download Center

ICC Profiles for Optimized Digital Printing Directly to Vinyl

↓ Select Logo for ICC Profile(s)



Charts & Resources

3M Controltac 180mC .....	60-61, 68	Badge Findings.....	260-263
3M 7725SE Dusted Cut Vinyl .....	77	Banana Buffers.....	166
3M 7725SE Frosted Cut Vinyl.....	77	Banner Hemming Tape .....	103-105
3M Knifeless Tape .....	157	Banner Material .....	90-91
3M Scotchcal™ Translucent™ Series 3630.....	62-63	Banner Stands.....	94-99
3M Scotchcal™ ElectroCut™ Series 7125.....	56-57, 69	Banner Ups® Adhesive Grommets and Banner Tape .....	101-105
3M Scotchcal™ ElectroCut™ Series 7725.....	58-59, 70	Bernzomatic High Heat Torch Nozzle.....	158
3M Scotchcal™ Series 50.....	64-65	Big Blue Safety Ruler .....	145
3M Scotchlite™ Reflective Series 5100R.....	74	Blade Disposal Cans .....	154
3M Scotchlite™ Reflective Series 680.....	72	Braille Beads .....	251
3M Scotchlite™ Reflective 680CR.....	73	Bravo Tabs .....	101
ADA Applique & Sheet Stock .....	252-253	Bumper Pole.....	171
ADA Signs.....	198-199	Cap Press .....	218, 221, 224, 227-228
Adhesive Grommet Tabs .....	101-102	Cast Aluminum Plaques .....	210-211
Air Release Tools .....	150	CE7000 Plotter Series .....	215
Application Fluid .....	173	Chalkboard Cut Vinyl.....	80
Application Charts.....	270-283	Changeable Copy Letters .....	200-205
Application Tools .....	144-175	Chizzler Removal Tool.....	161
Aslan Printable Glass Décor Film.....	25	ClearShield Select Liquid Overlamine.....	44
Atomic Heat Transfer Material.....	139	Clear PowerTape .....	103
AutoMark Wrap Vinyl .....	8,11	Color Change Film .....	48-53
Auto Sauce Wrap Care Products.....	174-175	Controltac™.....	60-61, 68
Auto Skins Wall Racks .....	171	Corner Shaper & Dies .....	238
Auto Skins Tools.....	171	Coro Claw Cutters.....	146
Avery Dennison DOL 1000Z Series.....	33-36	Corrugated Plastic .....	207-208
Avery Dennison DOL 2000 Series.....	38	Cube Banner Stands .....	96
Avery Dennison DOL 3000 Series.....	44	Cutting Mats & Grids.....	146
Avery Dennison DOL 6460 PVC Free .....	37	Cut Vinyl.....	56-80
Avery Dennison MPI 1105 EZ RS, 1105 EZ & 1105 EZ RS Kit .....	9	Curl Free Banner Material .....	91
Avery Dennison MPI 2050 Translucent.....	12	Desk Holders & Wall Brackets.....	206
Avery Dennison MPI 2105 EZ RS & 2105 EZ.....	12	Die Sets.....	100, 238
Avery Dennison MPI 2126 High Tack EZ.....	12	Digital Print Vinyl .....	8-31
Avery Dennison MPI 2611 .....	19	Drift Wrap Material .....	11
Avery Dennison MPI 2630.....	19	Dual Liner Cutter.....	151
Avery Dennison MPI 2902.....	13	Duets® Accents™.....	250
Avery Dennison MPI 2903 & 2903 EZ.....	16	Duets Contours® Flexible Sheet Stock .....	255
Avery Dennison MPI 2920.....	15	Duets Dura-Guard Laser XT Sheet Stock.....	257
Avery Dennison MPI 2921, 2921 EZ.....	13	Duets Glow Sheet Stock.....	253
Avery Dennison MPI 2923 EZ.....	15	Duets Laser Indoor Sheet Stock .....	254
Avery Dennison MPI 3300 & 3320.....	28	Duets Laser XT Reverse Sheet Stock.....	249
Avery Dennison MPI 3303 & 3323.....	29	Duets Plastic Sheet Stock .....	244-259
Avery Dennison SF100 - 128, 231 & 235.....	75	Duets Rotary Indoor Sheet Stock.....	258-259
Avery Dennison MPI 1106 High Tack EZ.....	10	Duets Selects Sheet Stock .....	244
Avery Dennison MPI 1405 EZ RS PVC Free .....	10	Duets Tactiles® ADA & Applique Sheet Stock.....	252-253
Avery Dennison Squeegees.....	163, 164	Duets Textures Sheet Stock.....	245
Avery Dennison SW900 Supreme Wrapping Film .....	48-53	Duets Ultimates/Ultimates Reverse Sheet Stock.....	246-248
Avery Dennison Tool Belt .....	167	Duets XT Outdoor/Indoor Sheet Stock .....	256-257
Avery Dennison Tools .....	147, 163-165, 167	Dusted Cut Vinyl .....	77
Avery Dennison Paint Mask.....	75	Emblem Removal Tool Set .....	160
Avery Dennison Wrap Care Products .....	175	Engravable Plastic .....	242-259
Avery Dennison V4000 Easy Apply RS Printable Reflective .....	71	Etched Glass Digital Print Vinyl.....	24

EXCEL Tools & Replacement Blades.....	148-150	Graphtec Plotter Cutters.....	214-215
EZPunch.....	101	Graphtec Media Baskets.....	215
FC9000 Plotter Series.....	214	Grommets, Grommet Press & Grommet Dies.....	100
Felt Block Squeegee.....	164	H-Stakes.....	208-209
Felt Squeegee Sleeves.....	165	Heat Conductive Pad.....	237
Floor Racks.....	170	Heat Gun.....	159
Floor Vinyl.....	9, 13, 16, 26-27	Heat Presses.....	192-201
FoamWerks Straight Cutter.....	145	Heat Press Supplies.....	234-237
Frosted Cut Vinyl.....	77	Heat Transfer Material.....	108-141
Gemini Duets Plastics.....	242-259	High Bond Mounting Tapes.....	176
General Formulations 100 & 102 Overlamine.....	42	Hiker Grommet Press.....	100
General Formulations 108 Tedlar Anti-Graffiti Overlamine.....	45	HIX Heat Press.....	222
General Formulations 109 Overlamine.....	42	Holographic Film.....	31
General Formulations 110 EraseMark Pro.....	45	HOTRONIX Accessories.....	229-235
General Formulations 201 HTAP & 203 HTAP.....	18	HOTRONIX Heat Presses.....	224-228
General Formulations 201 HTAPAE & 203 HTAPAE.....	18	Image One Impact Tools.....	150
General Formulations 201 Matte & 203 Gloss.....	17	INSTA Heat Press.....	223
General Formulations 201 OPAAE & 203 OPAAE.....	16	Intepro Corrugated Plastics.....	207-208
General Formulations 202 Matte & 204 Gloss.....	14	JDS Laserable Plastic.....	242-243
General Formulations 210 Traffic Graffic.....	27	Knifeless Tape.....	157
General Formulations 211 Overlamine.....	43	Knives & Cutters.....	147-155
General Formulations 212 Traffic Graffic.....	26	Kota Pro ADA Signs.....	198-199
General Formulations 213 Non-PVC Overlamine.....	43	Kota Pro Banner Material.....	90-91
General Formulations 220 Gloss & 222 Matte.....	17	Kota Pro Banner Stands.....	94-99
General Formulations 221 Gloss & 223 Matte.....	14	Kota Pro Desk Holders & Wall Brackets.....	206
General Formulations 226 WallMark & 226 HTR WallMark.....	20	Kota Pro Double Sided Banner Tape.....	104
General Formulations 229 HTR Matte Canvas.....	21	Kota Pro Emblem Removable Tool.....	160
General Formulations 230 AutoMark & WRAP KIT.....	11	Kota Pro Heat Transfer Material.....	108-110
General Formulations 231 & 240 Overlamine.....	39	Kota Pro Liner Cutters.....	151
General Formulations 232 WindowMark.....	23	Kota Pro Media Clips.....	172
General Formulations 333 AutoMark Drift PW.....	11	Kota Pro Multi-Layer Stand-offs.....	189
General Formulations 234 GraphiTex.....	20	Kota Pro PTFE Tape.....	164
General Formulations 235 MotoMark LSE Grip.....	18	Kota Pro Screw Caps.....	196-197
General Formulations 238 AutoMark Armor UV Overlamine.....	40	Kota Pro Stainless Steel Tamper-proof Screws.....	191
General Formulations 242 Opt. Clear Overlamine.....	37	Kota Pro Stand-off Hole Locator.....	190
General Formulations 255 Optically Clear.....	22	Kota Pro Stand-Offs.....	186-189, 192-196
General Formulations 270 WindowMark.....	23	Kota Pro Squeegees.....	161
General Formulations 280 WindowMark.....	24	Kota Pro PTFE Tape.....	164
General Formulations 285 RoughMark.....	21	Kota Pro Tool Sets.....	160
General Formulations 400 & 402 UV Overlamine.....	41	Laserable Plastic.....	242-250, 252-257
General Formulations 765 Rainbow Holographic Film.....	31	LED Stand-Offs.....	186-187
General Formulations 790AE.....	24	Lidco Big Blade Removal Tools.....	161
General Formulations 813 High Gloss Clear UV Cast.....	32	Lidco Squeegees.....	162
General Formulations 830 AutoMark Cast Wrap.....	8	Liner Cutter & Replacement Blades.....	151
General Formulations 830 Series Wrap Kits.....	8	Lumina 4200 Series.....	66
General Formulations 831 & 840 AutoMark UV Overlaminates.....	34	Lumina 4301 Series.....	67
General Formulations 844 Ulti-Matte Clear Cast.....	32	Lumina 7262 Series.....	76
Geo Knight Heat Press.....	216-221	Magnum Magnetic Film.....	30
Gold Line Tape.....	176	Magnetic Sheets.....	30
Graphtec Accessories & Replacement Parts.....	215	Magnets.....	160, 167, 260
Graffiti Print Heat Transfer Material.....	141	Magnetic Tools Set.....	160

Media Clips.....	172	SEF ReflexCut.....	140
Media Racks.....	170-171	SEF Tatoo SBB.....	138
Media Straps.....	172	Shears.....	239
MegaTape.....	103	Snitty Cutter.....	147
MetalFlex Heat Transfer Material.....	140	Sooper Edge Safety Ruler.....	145
Monkey Strips.....	166	Squeegees.....	161-164
Mounting Tape.....	176	Stahls PRE-CUT Numbers.....	111
Mug Press Attachment.....	221	Stahls CAD-CUT.....	112-131
Nomex Pads.....	237	Stahls CAD-COLOR.....	132-135
OLFA Tools.....	152-155	Stand-Offs & Stand-Off Displays.....	186-197
Paint Mask.....	75	Static Cling.....	76
PET Gray Back.....	91	Supreme Wrapping Film.....	48-53
PLASTICADE Sign Frames.....	180-185	Tapes.....	81-85, 103-105, 157, 164, 235
Plotters, Blades & Accessories.....	214-215	Tesa Tape.....	176
PoleTape & PoleTape Pro.....	105	Teflon Sheets and Table Wraps.....	236
PolyTabs.....	102	TigerTape.....	104
Poster Material.....	92-93	Tool Belt.....	167-168
Power Punch.....	101	Tools & Tapes.....	144-177
PowerTabs.....	102	Torch Nozzle.....	158
PowerTape.....	103	Traffic Graffiti.....	26-27
Printable Heat Transfer Material.....	109-110,132-135, 141	Transfer Tape.....	81-85
Print Receptive Plastic.....	243	TransferRite Transfer Tape & Films.....	81-83
Printable Reflective Film.....	71	Tuck Tool Set.....	160
PROBELT.....	168	Vinyl Removal Wheel.....	158
PROBUFFERS.....	165	VinylEFX Brushed.....	78-79
PROFINISHER Wrap Finishing Tools.....	168	VinylEFX ChalkTalk Decorative.....	80
PROFORM.....	169	VinylEFX Diamond Plate.....	80
PROGLOVES.....	169	VinylEFX Florentine Leaf.....	78-79
PROKNIFE.....	147	VinylEFX Large Engine Turn.....	79
Pronto™ Letters & Accessories.....	200-205	VinylEFX Metal Flake.....	78
PROSERIES Tools.....	147,165,168-169	VinylEFX Smooth Mirror.....	78-79
PTFE Glass Cloth Tape and Film Tape.....	164	Wall Brackets.....	170-171
Rapid Tac Products.....	173	Wall Films.....	9, 13, 15-16, 19-21, 28-29
Reflective Vinyl.....	71-74	Wall Racks.....	170-171
Reflective Heat Transfer Material.....	126, 131, 140	Weeding Tools.....	150
Removal Fluid.....	173	Weldy Heat Guns.....	159
Removal Tools.....	149, 155, 158, 161	Wet Edge Squeegee.....	164
Replacement Blades.....	145, 147, 148-149,151-155	Window Films.....	12-14, 22
Retractable Banner Stands.....	94-98	Window Perf.....	23-24
RollePro.....	156	Wrap Film.....	8-11, 48-53
RotaTrim Rotary Trimmers.....	144	Wrap Gloves.....	169
Rtape Transfer Tape & Films.....	84-85	Wrap Hook.....	171
Safety Rulers.....	145	Wrap Kits.....	8-9, 11
SEF FlexCut Atomic.....	139	X Banner Stands.....	99
SEF FlexCut Maxx.....	137	Xtreme Cutting Mats & Grids.....	146
SEF FlexCut MetalFlex.....	140	Z Straps.....	172
SEF FlexCut Nylon.....	139		
SEF FlexCut SBB.....	138		
SEF FlexTape.....	141		
SEF Graffiti.....	141		



# TERMS & CONDITIONS

## CLAIMS, RETURNS & SHIPPING

**ALL CLAIMS AND DISCREPANCIES MUST BE REPORTED WITHIN 10 DAYS OF RECEIPT OF SHIPMENT**

**CLAIMS:** Deductions from remittances will not be allowed unless authorized by JDS Industries in writing. All claims for lost or damaged merchandise can be filed with JDS Industries, Inc. JDS Industries' liability ceases upon freight carriers receipt of shipment in good order. **TRUCK SHIPMENTS** - Count and inspect packages for damage **BEFORE** signing the freight bill. Describe any damage or carton shortages on the bill and file a claim with the carrier.

**RETURNS:** All products to be returned due to incorrect item shipped or defective merchandise must receive prior approval by JDS Industries. Return of customer error stock merchandise will be subject to a **15%** restocking charge minimum. Credit will not be given for products received in unsellable condition. Credit for returned merchandise will be applied upon receipt and inspection of products. Custom and cut merchandise is nonreturnable. All requests to return goods must be received within **30 days** of receipt of original purchase. Any replacement items shipped on Net Terms will be charged to the credit card on file if not returned within 30 days.

**BACKORDERS:** All backorders will be shipped as merchandise is available unless previously cancelled by customer.

**SHIPPING:** All orders will be shipped UPS, FedEx or truck unless otherwise specified. Truck shipments are sent freight collect, unless other arrangements have been made. Truck shipments can be sent prepaid and we will bill your account for an additional **\$10** fee. A charge may be added for shipments that require delivery to the post office. Some services are not available from all warehouses.

**DOUBLE BOXING:** A **\$2.00** fee will be charged for each box when double boxing is requested.

**BLANK LABEL:** A **\$2.00** fee will be charged for each box when a blank label is requested.

**SHIPPING MARBLE:** JDS is not liable for damage when marble is sent by any method other than truck or will call.

## PAYMENT OPTIONS

**ACH:** Electronic Payment directly from a bank account. Payments can be made at the time of order or as a payment on your account to avoid the **2%** credit card convenience fee.

### CASH ON DELIVERY (COD):

Payment is made at time of delivery. COD charges apply.

### CREDIT CARD:

Payments are made at the time of order. Payments made by credit card after the date of invoice will be accepted for a **2%** convenience fee.



**WIRES:** Wires under \$500.00 will be assessed a \$25.00 wire fee charge. JDS will waive the \$25.00 wire fee for wires over \$500.00. Any fees charged by the customer's bank or by intermediate banks are the responsibility of the customer.

**TERMS:** Net 30 days from date of invoice to customers with approved credit. Credit application required and available upon request. Please allow **7-10** days for credit processing to be completed.

**PRICES ARE SUBJECT TO CHANGE WITHOUT NOTICE.**

## CONDITIONS

Any non-sufficient funds payments (NSF) will be subject to terms change and a **\$50.00** NSF fee.

Late payments will result in interest charges at the rate of **1.5%** per month (**18%** per annum). Customers whose accounts are 30 days past due will be shipped credit card, or ACH.

## Standard Ground Delivery



Corporate Office • 605.339.4010

JDS Sign Supply, Inc. • 1800 E 57th St N • PO Box 84806 • Sioux Falls, SD 57104-4806

*The partner you want. The service you deserve.*

# **SIGN SUPPLY**

*A Division of JDS Industries*

**855.661.2388**

Call Center Is Open, Monday-Friday  
7:00 a.m. to 7:00 p.m. CST

**Corporate Office:**

JDS Industries, Inc.  
1800 E 57th St N  
Sioux Falls, SD 57104-7115  
605.339.4010

PO Box 84806  
Sioux Falls, SD 57118-4806

  @jdssignsupply

## **13 Warehouses to Serve You!**

**Bonney Lake, WA**  
9713 233rd Ave E STE E  
Bonney Lake WA  
98391-2902

**Visalia, CA**  
9111 W Riggin Ave  
Visalia, CA  
93291-9263

**Phoenix, AZ**  
9191 W. Buckeye Rd.  
Suite 125  
Tolleson, AZ  
85353-4505

**Brownstown, MI**  
20001 Brownstown Center Dr  
STE 1060  
Brownstown, MI  
48183-1679

**Newark, NJ**  
220 Meadow Rd  
Edison, NJ  
08817-6011

**Sioux Falls, SD**  
1800 E 57th St N  
Sioux Falls, SD  
57104-7115

**St. Louis, MO**  
13781 Rider Trail N  
Earth City, MO  
63045-1205

**Chicago, IL**  
350 S Church St  
Addison, IL  
60101-3750

**Atlanta, GA**  
3105 Sweetwater Road  
Bldg 300, STE W  
Lawrenceville, GA  
30044-2447

**Jacksonville, FL**  
4102 Bulls Bay Hwy  
Unit 2A  
Jacksonville, FL  
32219-3232

**Charlotte, NC**  
200 Forsyth Hall Dr  
STE 200C-1  
Charlotte, NC  
28273-5797

**Grand Prairie, TX**  
2535 Gifford St  
Suite 200  
Grand Prairie, TX  
75050-4448

**Houston, TX**  
9254 Park South View  
STE 400  
Houston, TX  
77051-3063